

# NPN Medium Power Transistor (Switching)

UMT2222A/SST2222A/MMST2222A/RXT2222A/PN2222A

●Features

- 1)  $V_{CE0} < 40V$  ( $I_C = 10mA$ )
- 2) Complements the UMT2907A/SST2907A/MMST2907A /RXT2907A/PN2907A.

●Package, marking and packaging specifications

Type	UMT2222A	SST2222A	MMST2222A	RXT2222A	PN2222A
Package	UMT3	SST3	SMT3	MPT3	TO-92
Marking	R1P	R1P	R1P	CB*	—
Code	T108	T116	T148	T100	T93
Basic ordering unit (pieces)	3000	3000	3000	1000	3000

\* Indicates lot number.

●Absolute maximum ratings ( $T_a = 25^\circ C$ )

Parameter	Symbol	Limits	Unit	
Collector-base voltage	$V_{CB0}$	75	V	
Collector-emitter voltage	$V_{CE0}$	40	V	
Emitter-base voltage	$V_{EB0}$	6	V	
Collector current	$I_C$	0.6	A	
Collector power dissipation	$P_C$	UMT2222A, SST2222AV, MMST2222A	0.2	W *
		SST2222A	0.35	
		RXT2222A	0.5	
		PN2222A	0.625	
Junction temperature	$T_J$	150	$^\circ C$	
Storage temperature	$T_{stg}$	-55~150	$^\circ C$	

\* On 7 x 5 x 0.6 mm ceramic board

●External dimensions (Units : mm)

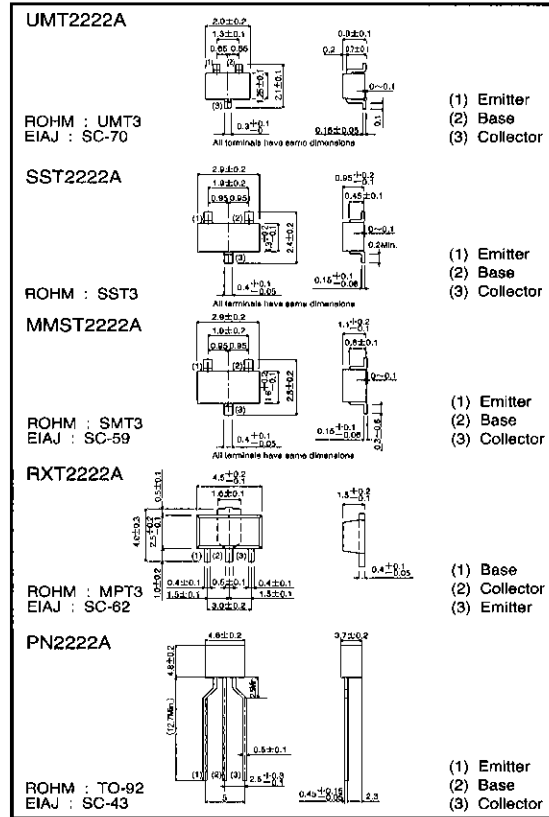

●Electrical characteristics ( $T_a = 25^\circ C$ )

Parameter	Symbol	Min.	Typ.	Max.	Unit	Conditions
Collector-base breakdown voltage	$BV_{CBO}$	75	—	—	V	$I_C = 10 \mu A$
Collector-emitter breakdown voltage	$BV_{CEO}$	40	—	—	V	$I_C = 10mA$
Emitter-base breakdown voltage	$BV_{EBO}$	6	—	—	V	$I_E = 10 \mu A$
Collector cutoff current	$I_{CBO}$	—	—	100	nA	$V_{CB} = 60V$
Emitter cutoff current	$I_{EBO}$	—	—	100	nA	$V_{EB} = 9V$
Collector-emitter saturation voltage	$V_{CE(sat)}$	—	—	0.3	V	$I_C/I_B = 150mA/15mA$
		—	—	1	V	$I_C/I_B = 500mA/50mA$
Base-emitter saturation voltage	$V_{BE(sat)}$	0.6	—	1.2	V	$I_C/I_B = 150mA/15mA$
		—	—	2	V	$I_C/I_B = 500mA/50mA$
DC current transfer ratio	$h_{FE}$	35	—	—	—	$V_{CE} = 10V, I_C = 0.1mA$
		50	—	—	—	$V_{CE} = 10V, I_C = 1mA$
		75	—	—	—	$V_{CE} = 10V, I_C = 10mA$
		50	—	—	—	$V_{CE} = 1V, I_C = 150mA$
		100	—	300	—	$V_{CE} = 10V, I_C = 150mA$
Transition frequency	$f_T$	300	—	—	MHz	$V_{CE} = 20V, I_C = -20mA, f = 100MHz$
		—	—	6	pF	$V_{CB} = 10V, f = 100kHz$
Output capacitance	$C_{ob}$	—	—	6	pF	$V_{EB} = 0.5V, f = 100kHz$
Emitter input capacitance	$C_{ib}$	—	—	25	pF	$V_{CC} = 30V, V_{BE(OFF)} = 0.5V, I_C = 150mA, I_{B1} = 15mA$
Delay time	$t_d$	—	—	10	ns	$V_{CC} = 30V, V_{BE(OFF)} = 0.5V, I_C = 150mA, I_{B1} = 15mA$
Rise time	$t_r$	—	—	25	ns	$V_{CC} = 30V, V_{BE(OFF)} = 0.5V, I_C = 150mA, I_{B1} = 15mA$
Storage time	$t_{stg}$	—	—	225	ns	$V_{CC} = 30V, I_C = 150mA, I_{B1} = -I_{B2} = 15mA$
Fall time	$t_f$	—	—	60	ns	$V_{CC} = 30V, I_C = 150mA, I_{B1} = -I_{B2} = 15mA$

(SPEC-C31)

● Electrical characteristic curves

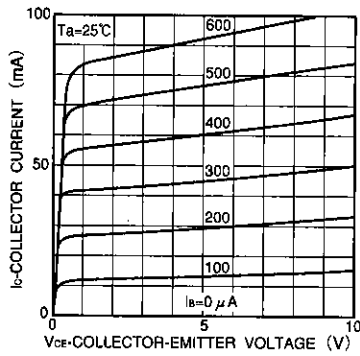

Fig.1 Grounded emitter output characteristics

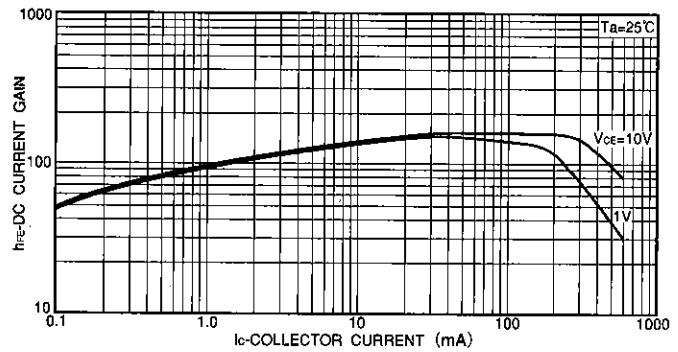

Fig.3 DC current gain vs. collector current ( I )

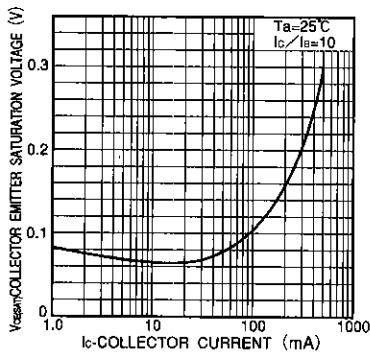

Fig.2 Collector-emitter saturation voltage vs. collector current

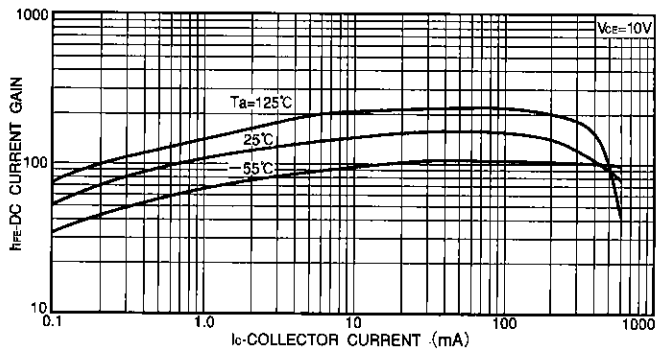

Fig.4 DC current gain vs. collector current ( II )

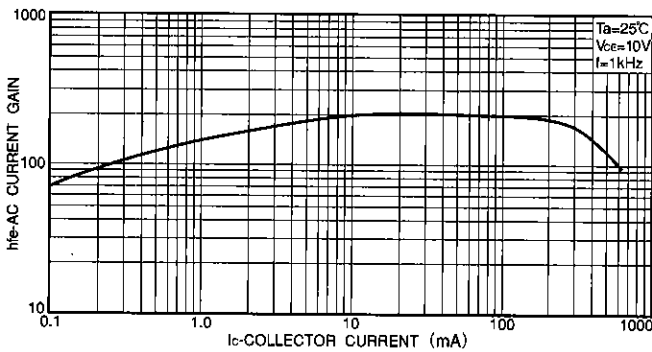

Fig.5 AC current gain vs. collector current

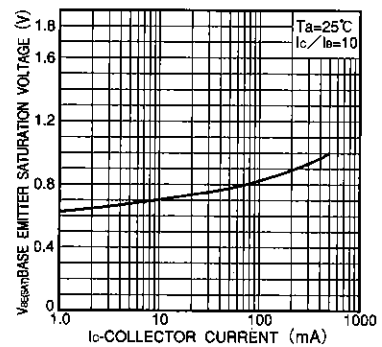

Fig.6 Base-emitter saturation voltage vs. collector current

USA & European specification models

● Electrical characteristic curves

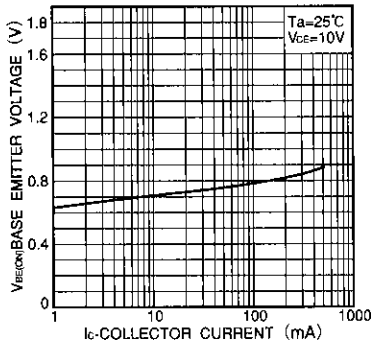

Fig.7 Grounded emitter propagation characteristics

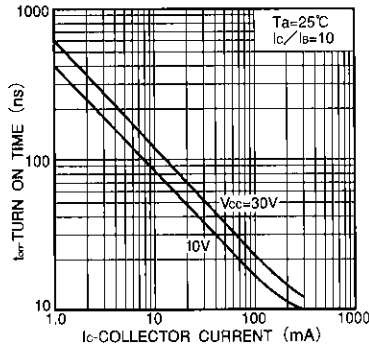

Fig.8 Turn-on time vs. collector current

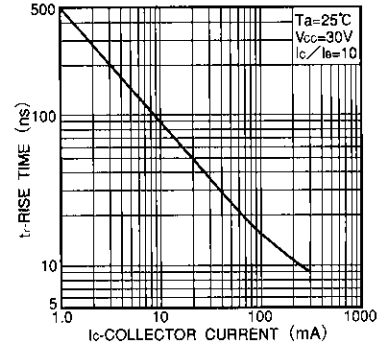

Fig.9 Rise time vs. collector current

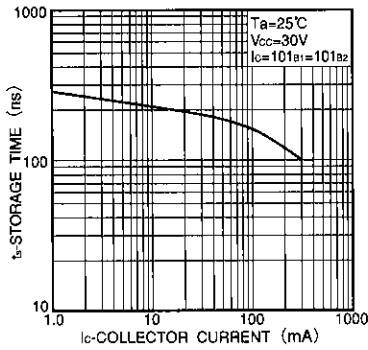

Fig.10 Storage time vs. collector current

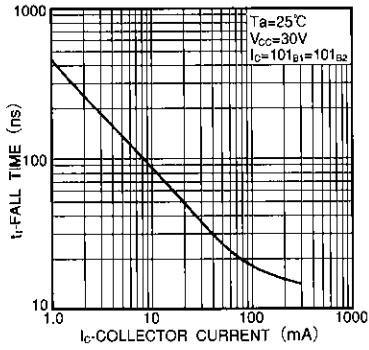

Fig.11 Fall time vs. collector current

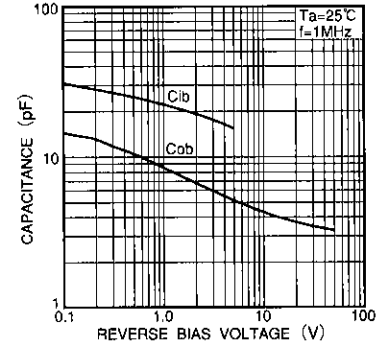

Fig.12 Input/output capacitance vs. voltage

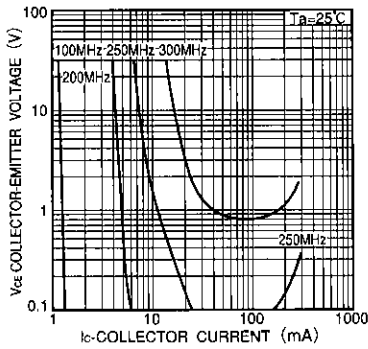

Fig.13 Gain bandwidth product

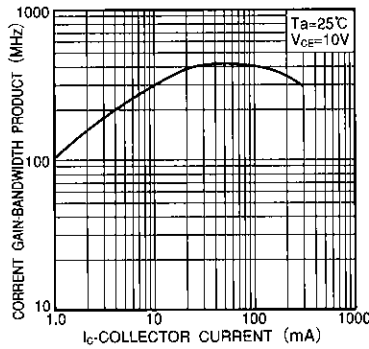

Fig.14 Gain bandwidth product vs. collector current

## Notes

- The contents described in this catalogue are correct as of March 1997.
- No unauthorized transmission or reproduction of this book, either in whole or in part, is permitted.
- The contents of this book are subject to change without notice. Always verify before use that the contents are the latest specifications. If, by any chance, a defect should arise in the equipment as a result of use without verification of the specifications, ROHM CO., LTD., can bear no responsibility whatsoever.
- Application circuit diagrams and circuit constants contained in this data book are shown as examples of standard use and operation. When designing for mass production, please pay careful attention to peripheral conditions.
- Any and all data, including, but not limited to application circuit diagrams, information, and various data, described in this catalogue are intended only as illustrations of such devices and not as the specifications for such devices. ROHM CO., LTD., disclaims any warranty that any use of such device shall be free from infringement of any third party's intellectual property rights or other proprietary rights, and further, assumes absolutely no liability in the event of any such infringement, or arising from or connected with or related to the use of such devices.
- Upon the sale of any such devices; other than for the buyer's right to use such devices itself, resell or otherwise dispose of the same; no express or implied right or license to practice or commercially exploit any intellectual property rights or other proprietary rights owned or controlled by ROHM CO., LTD., is granted to any such buyer.

The products listed in this catalogue are designed to be used with ordinary electronic equipment or devices (such as audio-visual equipment, office-automation equipment, communications devices, electrical appliances, and electronic toys). Should you intend to use these products with equipment or devices which require an extremely high level of reliability and the malfunction of which would directly endanger human life (such as medical instruments, transportation equipment, aerospace machinery, nuclear-reactor controllers, fuel controllers, or other safety devices) please be sure to consult with our sales representatives in advance.

- Notes when exporting
  - It is essential to obtain export permission when exporting any of the above products when it falls under the category of strategic material (or labor) as determined by foreign exchange or foreign trade control laws.
  - Please be sure to consult with our sales representatives to ascertain whether any product is classified as a strategic material.