

Ultra high-speed switching diode array

FMN1 / FMP1 / IMN10 / IMN11 / IMP11

UMN1N / UMP1N / UMN11N / UMP11N

●Applications

Ultra high speed switching

●Features

- 1) Multiple diodes in one small surface mount package.
- 2) A wide variety of configurations are available.
- 3) Diode characteristics are matched in the package.

●Construction

Silicon epitaxial planar

●External dimensions (Units: mm)

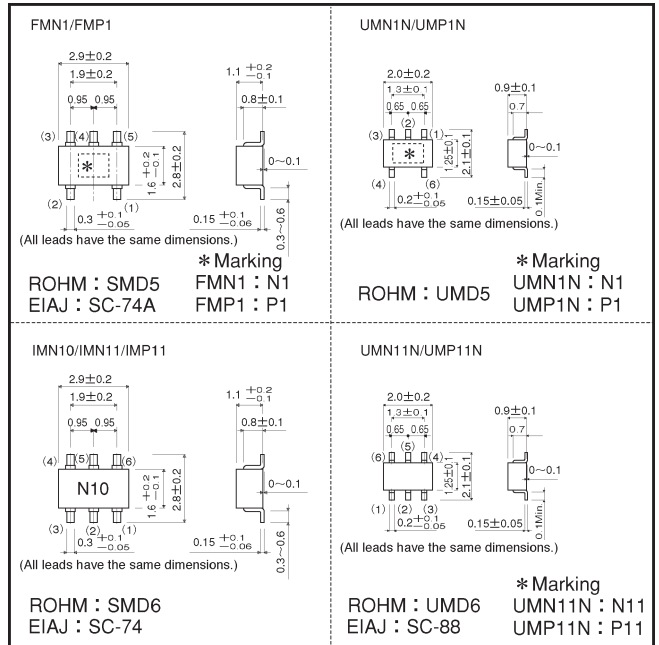

●Equivalent circuits

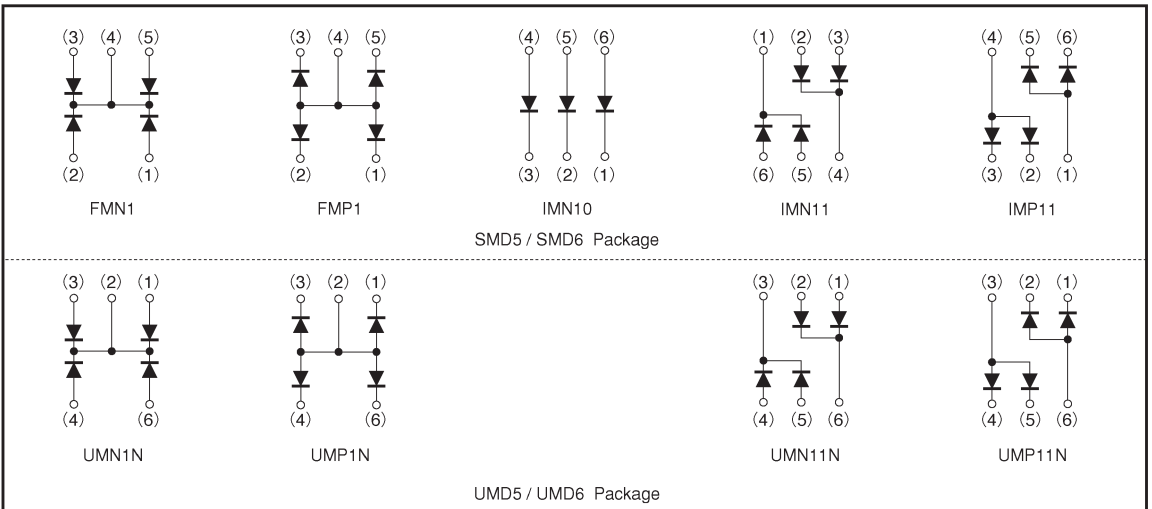

● Absolute maximum ratings (Ta = 25°C)

Type	Peak reverse voltage V _{RM} (V)	DC reverse voltage V _R (V)	Peak forward current I _{FM} (mA)	Mean rectifying current I _o (mA)	Surge current (1 μs) I _{surge} (A)	Power dissipation (TOTAL) Pd (mW)	Junction temperature T _j (°C)	Storage temperature T _{stg} (°C)
FMN1 UMN1N	80	80	80	25	0.25	150/80	150	-55~+150
FMP1 UMP1N	80	80	80	25	0.25	150/80	150	-55~+150
IMN10	80	80	300	100	4	300 *	150	-55~+150
IMN11 UMN11N	80	80	300	100	4	300 */150	150	-55~+150
IMP11 UMP11N	80	80	300	100	4	300 */150	150	-55~+150

* Not to exceed 200 mW per element.

● Electrical characteristics (Ta = 25°C)

Type	Forward voltage		Reverse current		Capacitance between terminals			Reverse recovery time		
	V _F (V) Max.	Cond.	I _R (μA) Max.	Cond.	C _T (pF) Max.	Cond.		t _r (ns) Max.	Cond.	
		I _F (mA)		V _R (V)		V _R (V)	f (MHz)		V _R (V)	I _F (mA)
FMN1 UMN1N	0.9	5	0.1	70	3.5	6	1	4	6	5
FMP1 UMP1N	0.9	5	0.1	70	3.5	6	1	4	6	5
IMN10	1.2	100	0.1	70	3.5	6	1	4	6	5
IMN11 UMN11N	1.2	100	0.1	70	3.5	6	1	4	6	5
IMP11 UMP11N	1.2	100	0.1	70	3.5	6	1	4	6	5

● Electrical characteristic curves (Ta = 25°C unless specified otherwise)

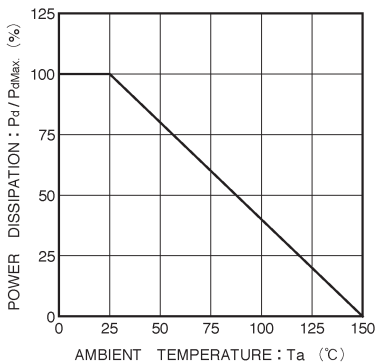

Fig. 1 Power reduction curve

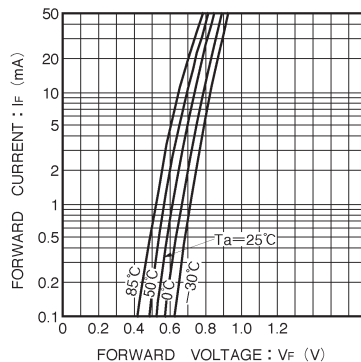

Fig. 2 Forward current vs. forward voltage (P TYPE)

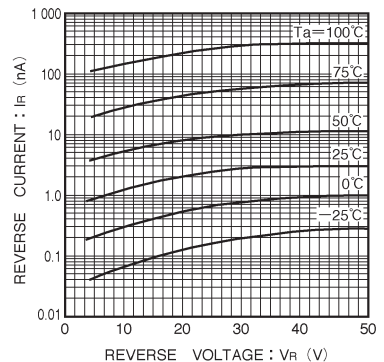

Fig. 3 Reverse current vs. reverse voltage (P TYPE)

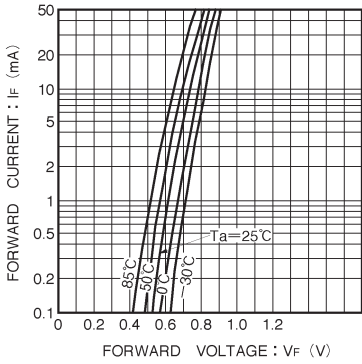

Fig. 4 Forward current vs. forward voltage (N TYPE)

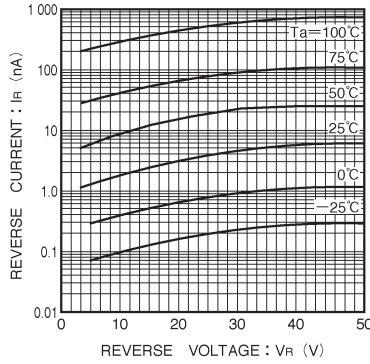

Fig. 5 Reverse current vs. reverse voltage (N TYPE)

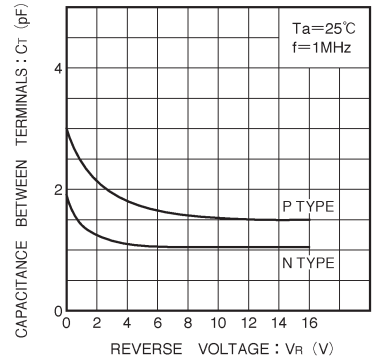

Fig. 6 Capacitance between terminals vs. reverse voltage

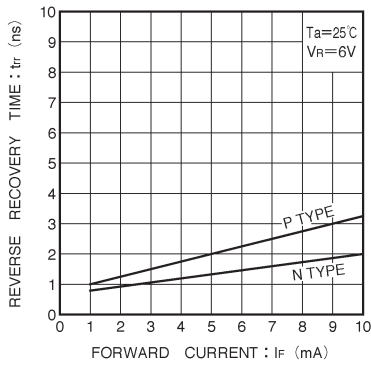

Fig. 7 Reverse recovery time vs. forward current

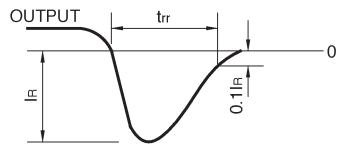
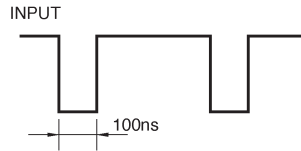
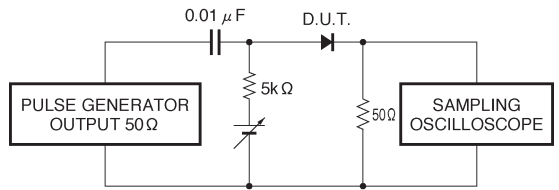

Fig. 8 Reverse recovery time (T_{rr}) measurement circuit