

3V RAIL TO RAIL CMOS DUAL OPERATIONAL AMPLIFIER (WITH STANDBY POSITION)

- DEDICATED TO **3.3V** OR **BATTERY SUPPLY** (specified at 3V and 5V)
- RAIL TO RAIL INPUT AND OUTPUT VOLTAGE RANGES
- **STANDBY POSITION** : REDUCED CONSUMPTION (0.5 μ A) AND HIGH IMPEDANCE OUTPUTS
- SINGLE (OR DUAL) SUPPLY OPERATION FROM **2.7V TO 16V**
- EXTREMELY LOW INPUT BIAS CURRENT : **1pA** TYP
- SPECIFIED FOR **600 Ω** AND **100 Ω** LOADS
- LOW SUPPLY CURRENT : 200 μ A/Ampli

- **SPICE MACROMODEL** INCLUDED IN THIS SPECIFICATION

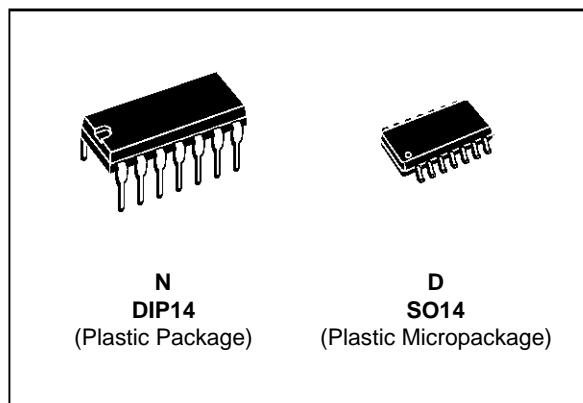

ORDER CODES

| Part Number | Temperature Range | Package | |
|-------------|------------------------|---------|---|
| | | N | D |
| TS3V902I/AI | -40, +125 $^{\circ}$ C | • | • |

PIN CONNECTIONS (top view)

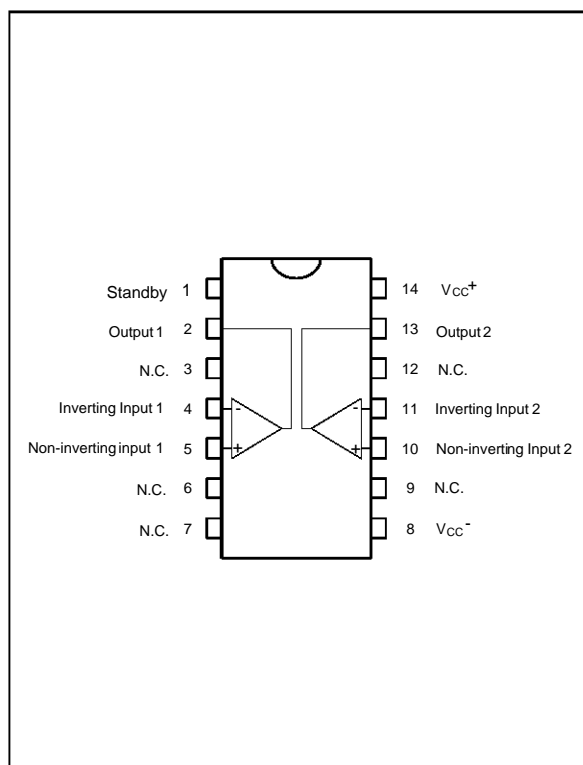

DESCRIPTION

The TS3V902 is a RAIL TO RAIL dual CMOS operational amplifier designed to operate with single or dual supply voltage.

The input voltage range V_{icm} includes the two supply rails V_{CC}^{+} and V_{CC}^{-} .

The output reaches ($V_{CC} = 5V$) :

- $V_{CC}^{-} + 50mV$ $V_{CC}^{+} - 50mV$ with $R_L = 10k\Omega$
- $V_{CC}^{-} + 350mV$ $V_{CC}^{+} - 400mV$ with $R_L = 600\Omega$

This product offers a broad supply voltage operating range from 2.7V to 16V and a supply current of only 200 μ A/amp. ($V_{CC} = 3V$).

Source and sink output current capability is typically 40mA (at $V_{CC} = 3V$), fixed by an internal limitation circuit.

The TS3V902 can be put on STANDBY position (only 0.5 μ A and high impedance outputs).

SGS-THOMSON is offering a quad op-amp with the same features : TS3V904.

SCHEMATIC DIAGRAM (1/2 TS3V902)

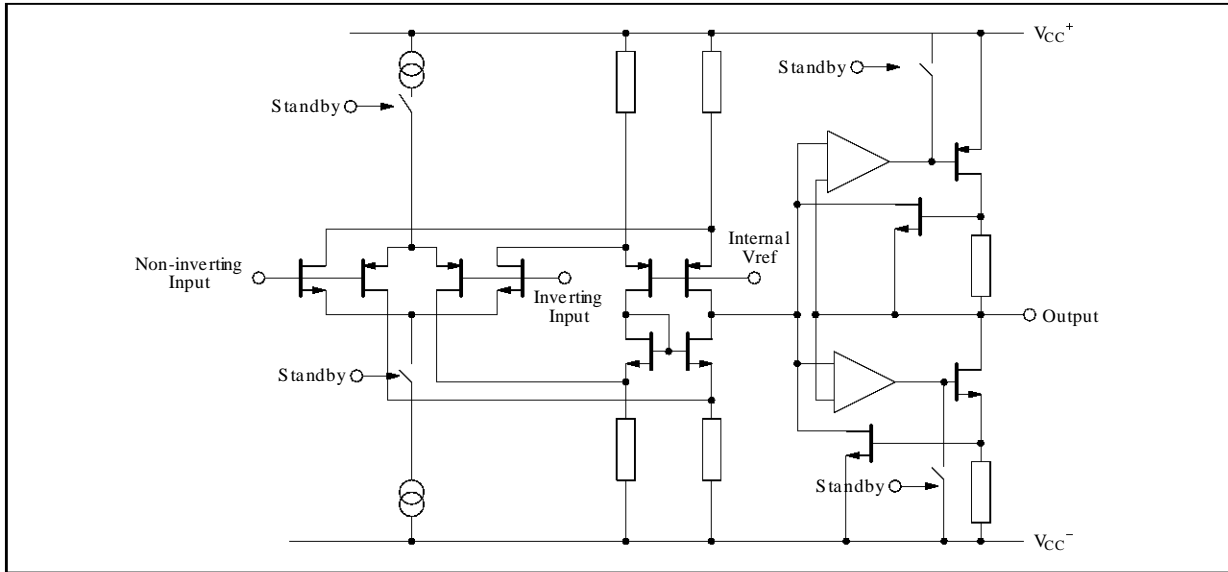

STANDBY POSITION

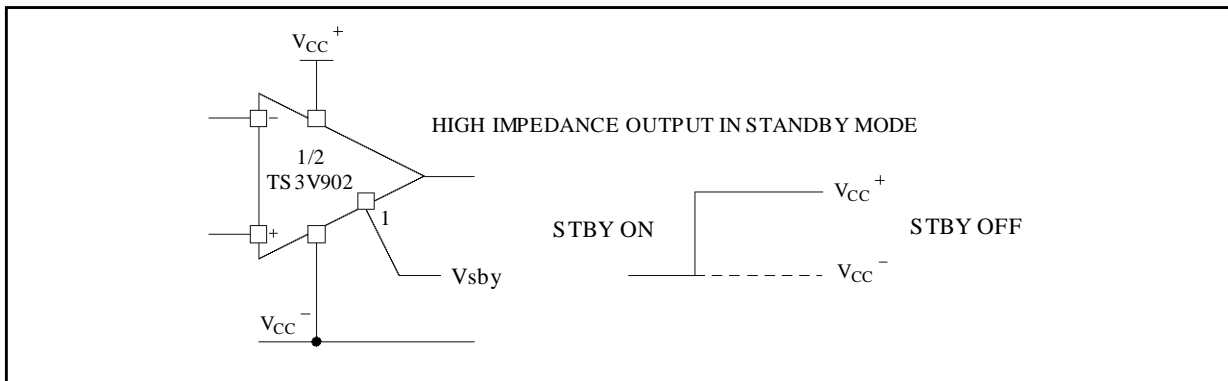

ABSOLUTE MAXIMUM RATINGS

| Symbol | Parameter | Value | Unit |
|------------|---------------------------------------|-------------|-------------|
| V_{CC} | Supply Voltage - (note 1) | 18 | V |
| V_{id} | Differential Input Voltage - (note 2) | ± 18 | V |
| V_i | Input Voltage - (note 3) | -0.3 to 18 | V |
| I_{in} | Current on Inputs | ± 50 | mA |
| I_o | Current on Outputs | ± 130 | mA |
| T_{oper} | Operating Free Air Temperature Range | -40 to +125 | $^{\circ}C$ |
| T_{stg} | Storage Temperature | -65 to +150 | $^{\circ}C$ |

- Notes :**
1. All voltage values, except differential voltage are with respect to network ground terminal.
 2. Differential voltages are the non-inverting input terminal with respect to the inverting input terminal.
 3. The magnitude of input and output voltages must never exceed $V_{CC}^+ + 0.3V$.

OPERATING CONDITIONS

| Symbol | Parameter | Value | Unit |
|-----------|---------------------------------|--------------------------------------|------|
| V_{CC} | Supply Voltage | 2.7 to 16 | V |
| V_{icm} | Common Mode Input Voltage Range | $V_{CC}^- - 0.2$ to $V_{CC}^+ + 0.2$ | V |

ELECTRICAL CHARACTERISTICS

$V_{CC}^+ = 3V$, $V_{CC}^- = 0V$, R_L, C_L connected to $V_{CC}/2$, Standby OFF, $T_{amb} = 25^\circ C$
(unless otherwise specified)

| Symbol | Parameter | TS3V902I/AI | | | Unit |
|-----------------|---|---|--------------------------|--------------------------------|------------------------|
| | | Min. | Typ. | Max. | |
| V_{io} | Input Offset Voltage ($V_{ic} = V_o = V_{CC}/2$) $T_{min.} \leq T_{amb} \leq T_{max.}$ | | | 10 5 12 7 | mV |
| DV_{io} | Input Offset Voltage Drift | | 5 | | $\mu V/^\circ C$ |
| I_{io} | Input Offset Current - (note 1) $T_{min.} \leq T_{amb} \leq T_{max.}$ | | 1 | 100 200 | pA |
| I_{ib} | Input Bias Current - (note 1) $T_{min.} \leq T_{amb} \leq T_{max.}$ | | 1 | 150 300 | pA |
| I_{CC} | Supply Current (per amplifier, $A_{VCL} = 1$, no load) $T_{min.} \leq T_{amb} \leq T_{max.}$ | | 200 | 300 400 | μA |
| CMR | Common Mode Rejection Ratio $V_{ic} = 0$ to $3V$, $V_o = 1.5V$ | | 60 | | dB |
| SVR | Supply Voltage Rejection Ratio ($V_{CC}^+ = 2.7$ to $3.3V$, $V_o = V_{CC}/2$) | | 80 | | dB |
| A_{vd} | Large Signal Voltage Gain ($R_L = 10k\Omega$, $V_o = 1.2V$ to $1.8V$) $T_{min.} \leq T_{amb} \leq T_{max.}$ | 3 2 | 10 | | V/mV |
| V_{OH} | High Level Output Voltage ($V_{id} = 1V$) $T_{min.} \leq T_{amb} \leq T_{max.}$ | $R_L = 10k\Omega$ $R_L = 600\Omega$ $R_L = 100\Omega$ $R_L = 10k\Omega$ $R_L = 600\Omega$ | 2.9 2.2 2.8 2.1 | 2.97 2.7 2 | V |
| V_{OL} | Low Level Output Voltage ($V_{id} = -1V$) $T_{min.} \leq T_{amb} \leq T_{max.}$ | $R_L = 10k\Omega$ $R_L = 600\Omega$ $R_L = 100\Omega$ $R_L = 10k\Omega$ $R_L = 600\Omega$ | | 30 250 900 150 900 | mV |
| I_o | Output Short Circuit Current ($V_{id} = \pm 1V$) | Source ($V_o = V_{CC}^-$) Sink ($V_o = V_{CC}^+$) | 40 40 | | mA |
| GBP | Gain Bandwidth Product ($A_{VCL} = 100$, $R_L = 10k\Omega$, $C_L = 100pF$, $f = 100kHz$) | | 0.7 | | MHz |
| SR | Slew Rate ($A_{VCL} = 1$, $R_L = 10k\Omega$, $C_L = 100pF$, $V_i = 1.3V$ to $1.7V$) | | 0.5 | | V/ μs |
| ϕ_m | Phase Margin | | 30 | | Degrees |
| e_n | Equivalent Input Noise Voltage ($R_s = 100\Omega$, $f = 1kHz$) | | 30 | | $\frac{nV}{\sqrt{Hz}}$ |
| V_{O1}/V_{O2} | Channel Separation ($f = 1kHz$) | | 120 | | dB |

Note 1 : Maximum values including unavoidable inaccuracies of the industrial test.

STANDBY MODE

$V_{CC}^+ = 3V$, $V_{CC}^- = 0V$, $T_{amb} = 25^\circ C$ (unless otherwise specified)

| Symbol | Parameter | TS3V902I/AI | | | Unit |
|-----------------|--|-------------|------|------|---------|
| | | Min. | Typ. | Max. | |
| $V_{inSBY/ON}$ | Pin 1 Threshold Voltage for STANDBY ON | | 1.2 | | V |
| $V_{inSBY/OFF}$ | Pin 1 Threshold Voltage for STANDBY OFF | | 1.2 | | V |
| $I_{CC SBY}$ | Total Consumption in Standby Position (STANDBY ON) | | 0.5 | | μA |

ELECTRICAL CHARACTERISTICS

$V_{CC}^+ = 5V, V_{CC}^- = 0V, R_L, C_L$ connected to $V_{CC}/2$, Standby OFF, $T_{amb} = 25^\circ C$
(unless otherwise specified)

| Symbol | Parameter | TS3V902I/AI | | | Unit |
|-----------|--|---|---------------------------|---------------------------------|------------------|
| | | Min. | Typ. | Max. | |
| V_{io} | Input Offset Voltage ($V_{ic} = V_o = V_{CC}/2$) $T_{min.} \leq T_{amb} \leq T_{max.}$ | | | 10 5 12 7 | mV |
| DV_{io} | Input Offset Voltage Drift | | 5 | | $\mu V/^\circ C$ |
| I_{io} | Input Offset Current - (note 1) $T_{min.} \leq T_{amb} \leq T_{max.}$ | | 1 | 100 200 | pA |
| I_{ib} | Input Bias Current - (note 1) $T_{min.} \leq T_{amb} \leq T_{max.}$ | | 1 | 150 300 | pA |
| I_{CC} | Supply Current (per amplifier, $A_{VCL} = 1$, no load) $T_{min.} \leq T_{amb} \leq T_{max.}$ | | 230 | 350 450 | μA |
| CMR | Common Mode Rejection Ratio $V_{ic} = 1.5$ to $3.5V, V_o = 2.5V$ | | 85 | | dB |
| SVR | Supply Voltage Rejection Ratio ($V_{CC}^+ = 2.7$ to $3.3V, V_o = V_{CC}/2$) | | 80 | | dB |
| A_{vd} | Large Signal Voltage Gain ($R_L = 10k\Omega, V_o = 1.5V$ to $3.5V$) $T_{min.} \leq T_{amb} \leq T_{max.}$ | 7 5 | 30 | | V/mV |
| V_{OH} | High Level Output Voltage ($V_{id} = 1V$) $T_{min.} \leq T_{amb} \leq T_{max.}$ | $R_L = 10k\Omega$ $R_L = 600\Omega$ $R_L = 100\Omega$ $R_L = 10k\Omega$ $R_L = 600\Omega$ | 4.85 4.2 4.8 4.1 | 4.95 4.6 3.7 | V |
| V_{OL} | Low Level Output Voltage ($V_{id} = -1V$) $T_{min.} \leq T_{amb} \leq T_{max.}$ | $R_L = 10k\Omega$ $R_L = 600\Omega$ $R_L = 100\Omega$ $R_L = 10k\Omega$ $R_L = 600\Omega$ | | 50 350 1400 150 900 | mV |
| I_o | Output Short Circuit Current ($V_{id} = \pm 1V$) | Source ($V_o = V_{CC}^-$) Sink ($V_o = V_{CC}^+$) | | 60 60 | mA |
| GBP | Gain Bandwidth Product ($A_{VCL} = 100, R_L = 10k\Omega, C_L = 100pF, f = 100kHz$) | | 0.8 | | MHz |
| SR | Slew Rate ($A_{VCL} = 1, R_L = 10k\Omega, C_L = 100pF, V_i = 1V$ to $4V$) | | 0.8 | | V/ μs |
| ϕ_m | Phase Margin | | 30 | | Degrees |

Note 1 : Maximum values including unavoidable inaccuracies of the industrial test.

STANDBY MODE

$V_{CC}^+ = 5V, V_{CC}^- = 0V, T_{amb} = 25^\circ C$ (unless otherwise specified)

| Symbol | Parameter | TS3V902I/AI | | | Unit |
|-----------------|--|-------------|------|------|---------|
| | | Min. | Typ. | Max. | |
| $V_{inSBY/ON}$ | Pin 1 Threshold Voltage for STANDBY ON | | 5.2 | | V |
| $V_{inSBY/OFF}$ | Pin 1 Threshold Voltage for STANDBY OFF | | 5.2 | | V |
| $I_{CC SBY}$ | Total Consumption in Standby Position (STANDBY ON) | | 0.5 | | μA |

TYPICAL CHARACTERISTICS

Figure 1a : Supply Current (each amplifier) versus Supply Voltage

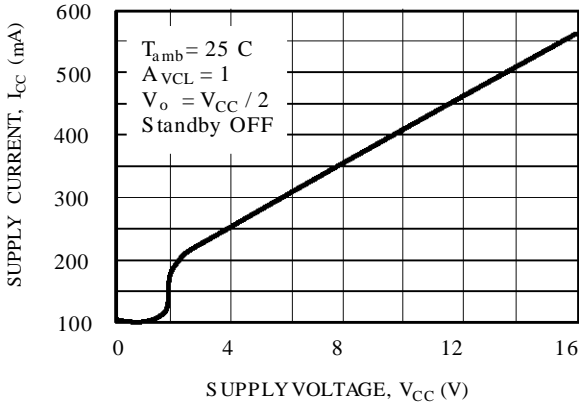

Figure 1b : Supply Current (each amplifier) versus Supply Voltage (in STANDBY mode)

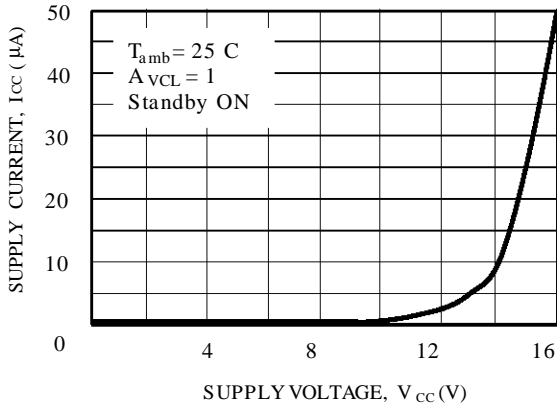

Figure 2 : Input Bias Current versus Temperature

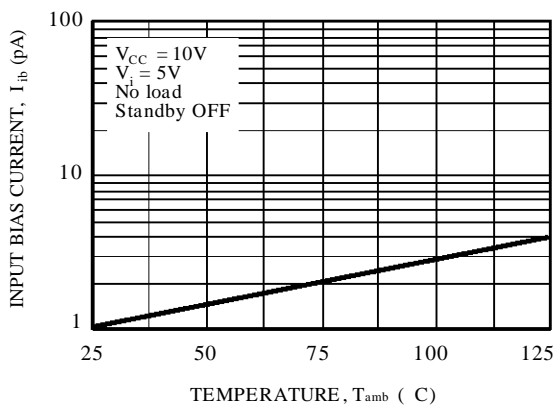

Figure 3a : High Level Output Voltage versus High Level Output Current

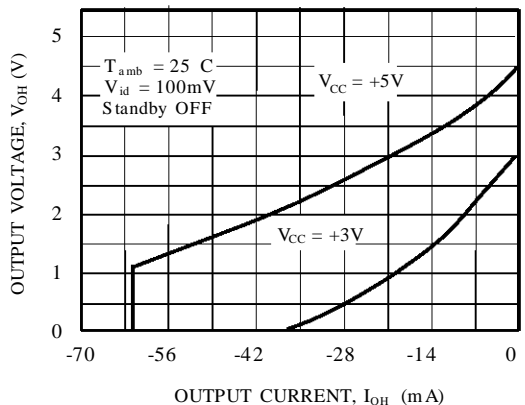

Figure 3b : High Level Output Voltage versus High Level Output Current

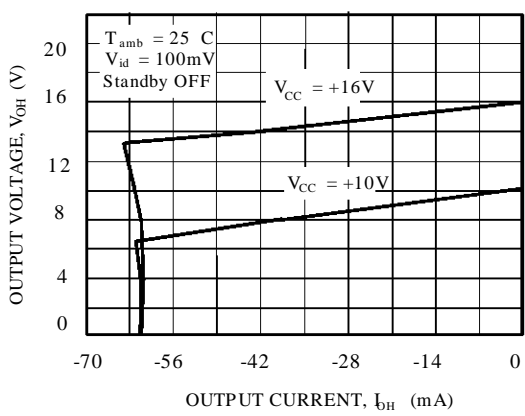

Figure 4a : Low Level Output Voltage versus Low Level Output Current

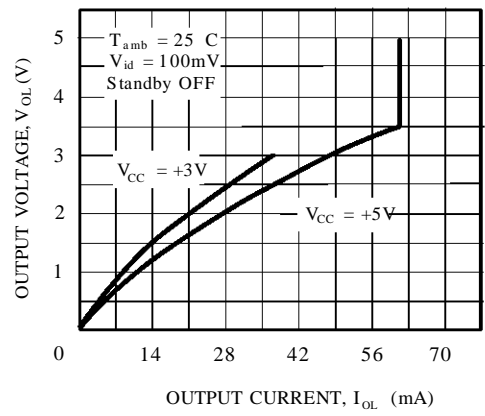

Figure 4b : Low Level Output Voltage versus Low Level Output Current

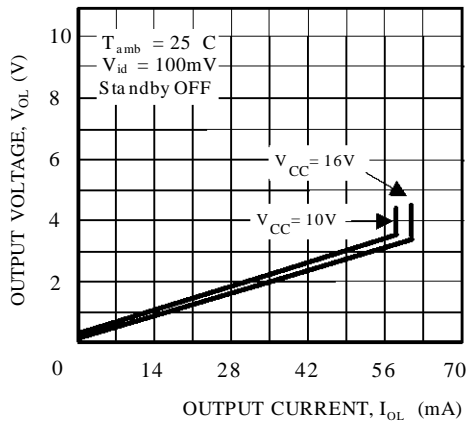

Figure 5a : Open Loop Frequency Response and Phase Shift

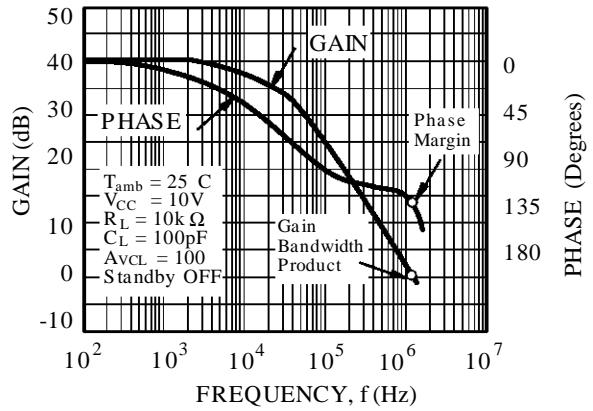

Figure 5b : Open Loop Frequency Response and Phase Shift

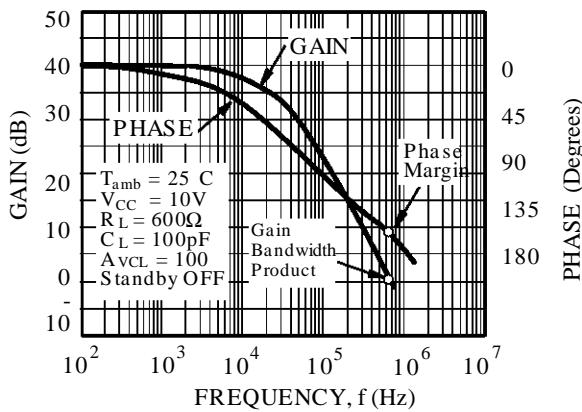

Figure 6a : Gain Bandwidth Product versus Supply Voltage

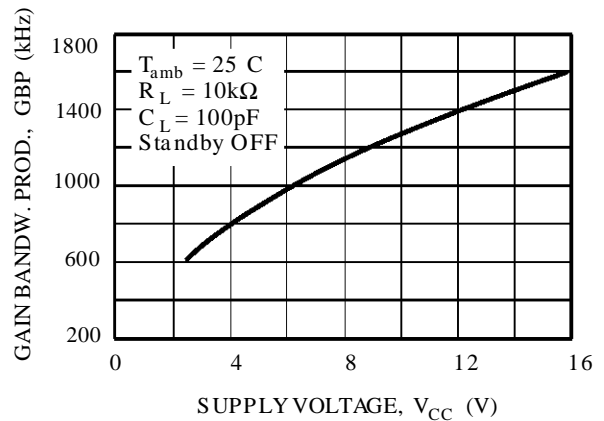

Figure 6b : Gain bandwidth Product versus Supply Voltage

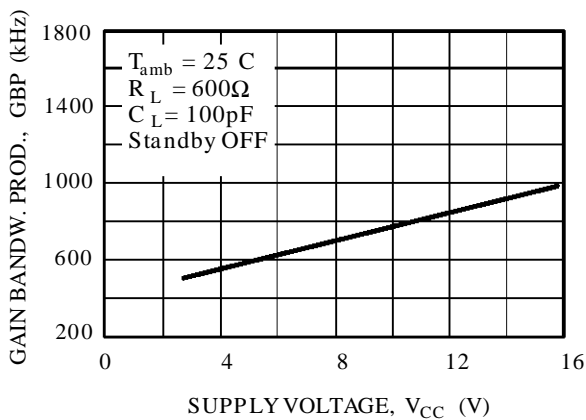

Figure 7a : Phase Margin versus Supply Voltage

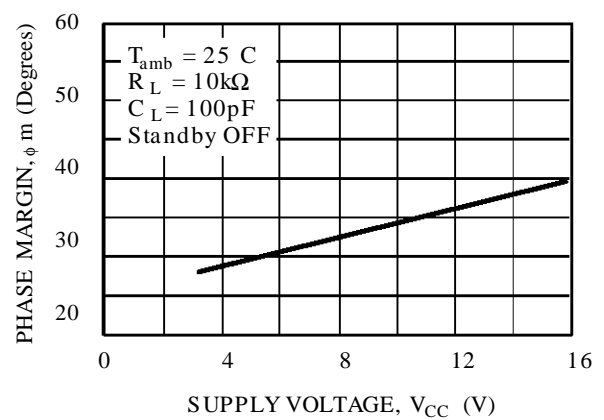

Figure 7b : Phase Margin versus Supply Voltage

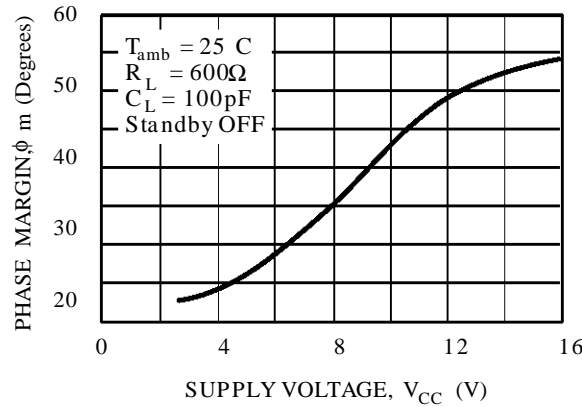
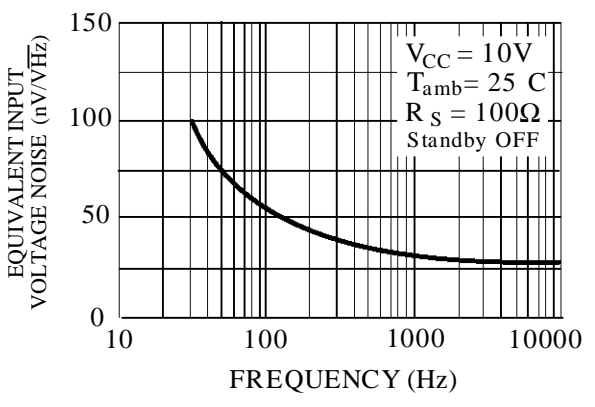

Figure 8 : Input Voltage Noise versus Frequency



STANDBY APPLICATION

The two operators of the TS3V902 are **both** put on **STANDBY**.

In this configuration (standby ON) :

- The **total consumption** of the circuit is considerably **reduced** down to **0.5μA** ($V_{CC} = 3V$). This standby consumption versus V_{CC} curve is given figure 1b.
- The **both outputs** are in **high impedance** state. No output current can then be sourced or sinked by the device.

The standby pin 1 should never stay unconnected.

- The **"standby OFF"** state, is reached when the pin 1 voltage is **higher than $V_{in SBY/OFF}$** .
- The **"standby ON"** state is assured by a pin 1 voltage **lower than $V_{in SBY/ON}$** . (see electrical characteristics)

ORDERING INFORMATION

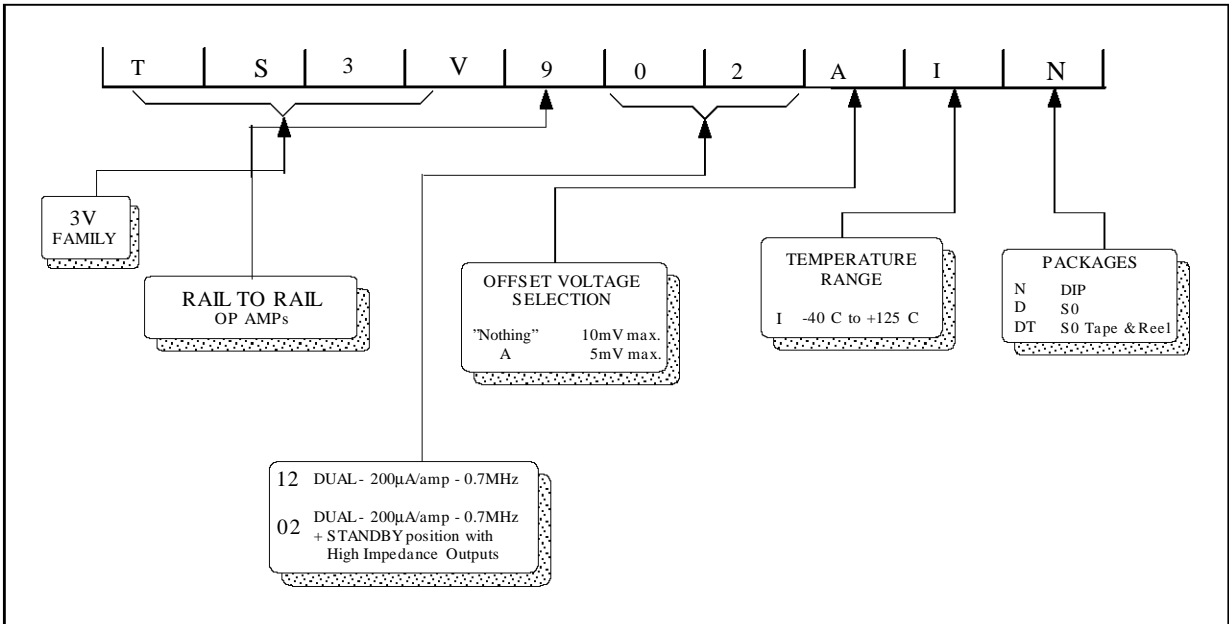

MACROMODEL

- RAIL TO RAIL INPUT AND OUTPUT VOLTAGE RANGES
- STANDBY POSITION : REDUCED CONSUMPTION (0.5µA) AND HIGH IMPEDANCE OUTPUTS
- SINGLE (OR DUAL) SUPPLY OPERATION FROM 2.7V TO 16V (±1.35V to ±8V)
- EXTREMELY LOW INPUT BIAS CURRENT : 1pA TYP
- LOW INPUT OFFSET VOLTAGE : 5mV max.
- SPECIFIED FOR 600Ω AND 100Ω LOADS
- LOW SUPPLY CURRENT : 200µA/Ampli
- SPEED : 0.7MHz - 0.5V/µs

Applies to : TS3V902I,AI

** Standard Linear Ics Macromodels, 1993.

** CONNECTIONS :

- * 1 INVERTING INPUT
- * 2 NON-INVERTING INPUT
- * 3 OUTPUT
- * 4 POSITIVE POWER SUPPLY
- * 5 NEGATIVE POWER SUPPLY
- * 6 STANDBY

.SUBCKT TS3V902 1 3 2 4 5 6 (analog)

.MODEL MDTH D IS=1E-8 KF=6.563355E-14 CJO=10F

* INPUT STAGE

CIP 2 5 1.500000E-12

CIN 1 5 1.500000E-12

EIP 10 0 2 0 1

EIN 16 0 1 0 1

RIP 10 11 6.500000E+00

RIN 15 16 6.500000E+00

RIS 11 15 7.655100E+00

DIP 11 12 MDTH 400E-12

DIN 15 14 MDTH 400E-12

VOFP 12 13 DC 0.000000E+00

VOFN 13 14 DC 0

FPOL 13 0 VSTB 1

CPS 11 15 3.82E-08

DINN 17 13 MDTH 400E-12

VIN 17 5 -0.5000000e+00

DINR 15 18 MDTH 400E-12

VIP 4 18 -0.5000000E+00

FCP 4 5 VOFP 8.6E+00

FCN 5 4 VOFN 8.6E+00

ISTB0 5 4 900NA

* AMPLIFYING STAGE

FIP 0 19 VOFP 5.500000E+02

FIN 0 19 VOFN 5.500000E+02

RG1 19 120 5.087344E+05

GCOM1 120 5 POLY(1) 110 109 LEVEL=1 6.25E+11

RG2 121 19 5.087344E+05

GCOM2 121 4 POLY(1) 110 109 LEVEL=1 6.25E+11

CC 19 29 2.200000E-08

HZTP 30 29 VOFP 12.33E+02

HZTN 5 30 VOFN 12.33E+02

DOPM 19 22 MDTH 400E-12

DONM 21 19 MDTH 400E-12

HOPM 22 28 VOUT 3135

VIPM 28 4 150

HONM 21 27 VOUT 3135

VINM 5 27 150

EOUT 26 23 19 5 1

VOUT 23 5 0

ROUT 26 103 65

COUT 103 5 1.000000E-12

GCOM 103 3 POLY(1) 110 109 LEVEL=1 6.25E+11

* OUTPUT SWING

DOP 19 68 MDTH 400E-12

VOP 4 25 1.924

HSCP 68 25 VSCP1 1E8

DON 69 19 MDTH 400E-12

VON 24 5 2.4419107

HSCN 24 69 VSCN1 1.5E8

VSCTHP 60 61 0.1375

DSCP1 61 63 MDTH 400E-12

VSCP1 63 64 0

ISCP 64 0 1.000000E-8

DSCP2 0 64 MDTH 400E-12

DSCN2 0 74 MDTH 400E-12

ISCN 74 0 1.000000E-8

VSCN1 73 74 0

DSCN1 71 73 MDTH 400E-12

VSCTHN 71 70 -0.75

ESCP 60 0 2 1 500

ESCN 70 0 2 1 -2000

* STAND BY

RMI1 4 111 1E+12

RMI2 5 111 1E+12

RSTBIN 6 0 1E+12

ESTBIN 106 0 6 0 1

ESTBREF 106 107 111 0 1

DSTB1 107 108 MDTH 400E-12

VSTB 108 109 0

ISTB 109 0 40U

RSTB 109 110 1

DSTB2 0 110 MDTH 400E-12

.ENDS

ELECTRICAL CHARACTERISTICS

$V_{CC}^+ = 5V$, $V_{CC}^- = 0V$, R_L, C_L connected to $V_{CC}/2$, standby off, $T_{amb} = 25^\circ C$
(unless otherwise specified)

| Symbol | Conditions | Value | Unit |
|-----------------|-----------------------------------|-------------|------------|
| V_{io} | | 0 | mV |
| A_{vd} | $R_L = 10k\Omega$ | 30 | V/mV |
| I_{CC} | No load, per operator | 230 | μA |
| V_{icm} | | -0.2 to 5.2 | V |
| V_{OH} | $R_L = 10k\Omega$ | 4.95 | V |
| V_{OL} | $R_L = 10k\Omega$ | 50 | mV |
| I_{sink} | $V_O = 10V$ | 60 | mA |
| I_{source} | $V_O = 0V$ | 60 | mA |
| GBP | $R_L = 10k\Omega$, $C_L = 100pF$ | 0.8 | MHz |
| SR | $R_L = 10k\Omega$, $C_L = 100pF$ | 0.8 | V/ μs |
| $\varnothing m$ | $R_L = 10k\Omega$, $C_L = 100pF$ | 30 | Degrees |
| $I_{CC\ STBY}$ | $V_{STBY} = 0V$ | 500 | nA |

TS3V902

PACKAGE MECHANICAL DATA
14 PINS - PLASTIC DIP

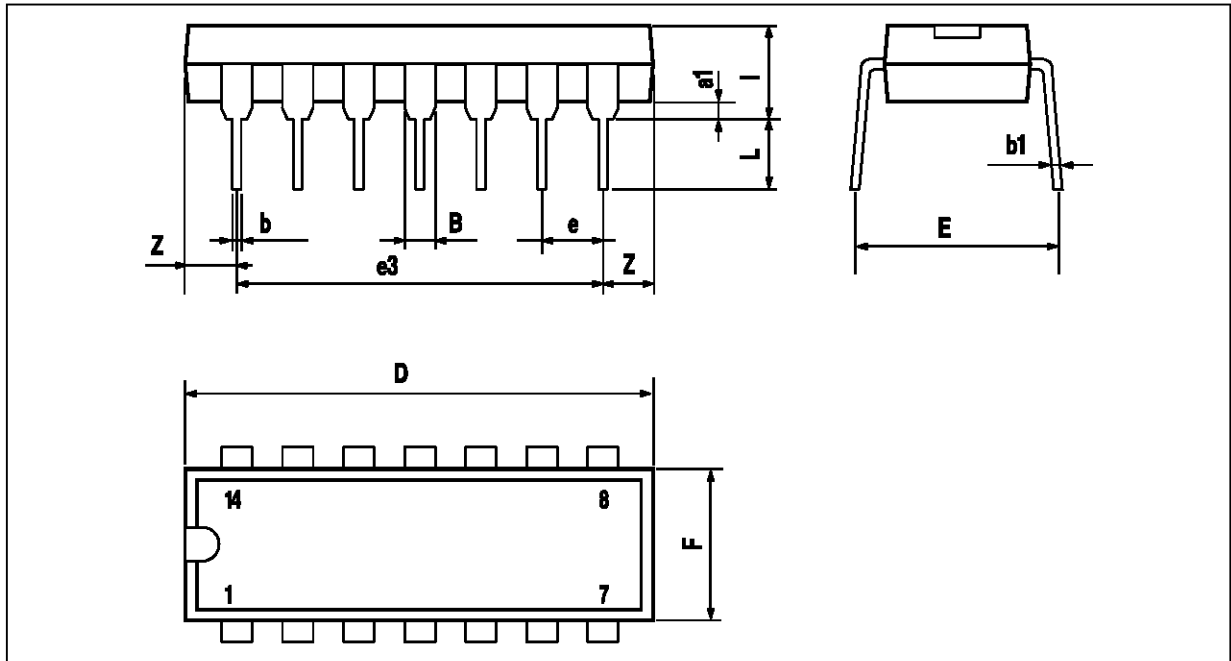

PM-DIP14EPS

| Dimensions | Millimeters | | | Inches | | |
|------------|-------------|-------|------|--------|-------|-------|
| | Min. | Typ. | Max. | Min. | Typ. | Max. |
| a1 | 0.51 | | | 0.020 | | |
| B | 1.39 | | 1.65 | 0.055 | | 0.065 |
| b | | 0.5 | | | 0.020 | |
| b1 | | 0.25 | | | 0.010 | |
| D | | | 20 | | | 0.787 |
| E | | 8.5 | | | 0.335 | |
| e | | 2.54 | | | 0.100 | |
| e3 | | 15.24 | | | 0.600 | |
| F | | | 7.1 | | | 0.280 |
| i | | | 5.1 | | | 0.201 |
| L | | 3.3 | | | 0.130 | |
| Z | 1.27 | | 2.54 | 0.050 | | 0.100 |

DIP14_TBL

PACKAGE MECHANICAL DATA
14 PINS - PLASTIC MICROPACKAGE (SO)

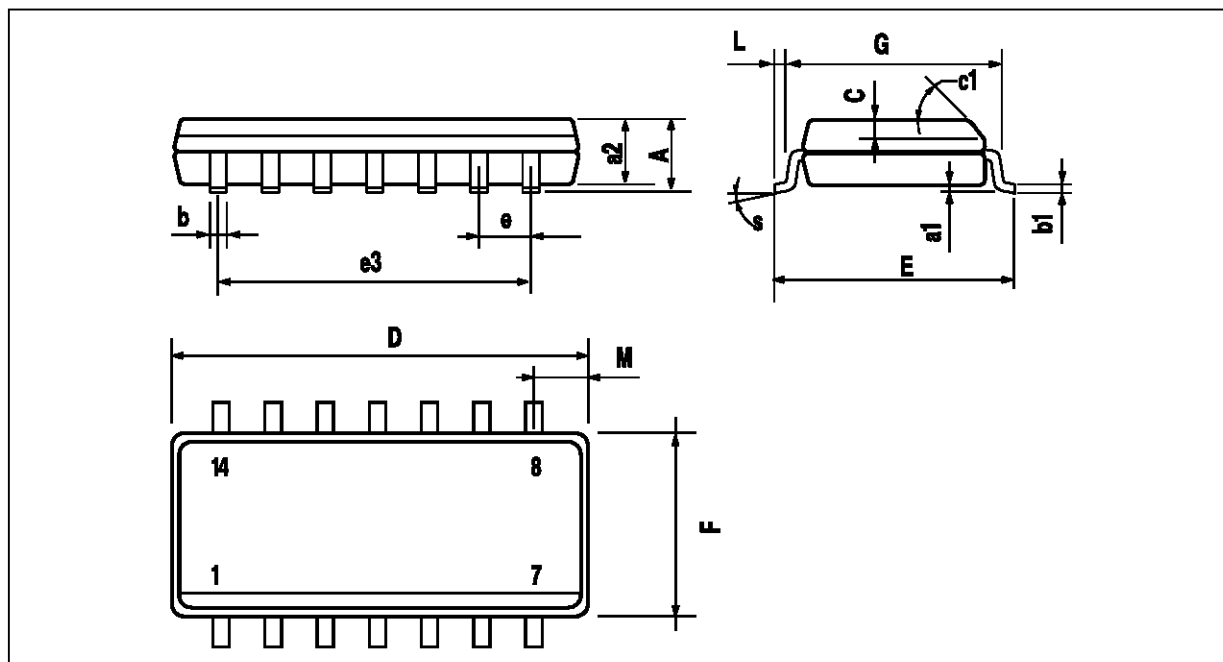

PM-SO14.EPS

| Dimensions | Millimeters | | | Inches | | |
|------------|-------------|------|------|--------|-------|-------|
| | Min. | Typ. | Max. | Min. | Typ. | Max. |
| A | | | 1.75 | | | 0.069 |
| a1 | 0.1 | | 0.2 | 0.004 | | 0.008 |
| a2 | | | 1.6 | | | 0.063 |
| b | 0.35 | | 0.46 | 0.014 | | 0.018 |
| b1 | 0.19 | | 0.25 | 0.007 | | 0.010 |
| C | | 0.5 | | | 0.020 | |
| c1 | 45° (typ.) | | | | | |
| D | 8.55 | | 8.75 | 0.336 | | 0.334 |
| E | 5.8 | | 6.2 | 0.228 | | 0.244 |
| e | | 1.27 | | | 0.050 | |
| e3 | | 7.62 | | | 0.300 | |
| F | 3.8 | | 4.0 | 0.150 | | 0.157 |
| G | 4.6 | | 5.3 | 0.181 | | 0.208 |
| L | 0.5 | | 1.27 | 0.020 | | 0.050 |
| M | | | 0.68 | | | 0.027 |
| S | 8° (max.) | | | | | |

SO14.TBL

Information furnished is believed to be accurate and reliable. However, SGS-THOMSON Microelectronics assumes no responsibility for the consequences of use of such information nor for any infringement of patents or other rights of third parties which may result from its use. No license is granted by implication or otherwise under any patent or patent rights of SGS-THOMSON Microelectronics. Specification mentioned in this publication are subject to change without notice. This publication supersedes and replaces all information previously supplied. SGS-THOMSON Microelectronics products are not authorized for use as critical components in life support devices or systems without express written approval of SGS-THOMSON Microelectronics.

© 1997 SGS-THOMSON Microelectronics – Printed in Italy – All Rights Reserved

SGS-THOMSON Microelectronics GROUP OF COMPANIES
Australia - Brazil - Canada - China - France - Germany - Hong Kong - Italy - Japan - Korea - Malaysia - Malta - Morocco
The Netherlands - Singapore - Spain - Sweden - Switzerland - Taiwan - Thailand - United Kingdom - U.S.A.

ORDER CODE :