

SMALL SIGNAL SCHOTTKY DIODES

DESCRIPTION

General purpose, metal to silicon diodes featuring very low turn-on voltage and fast switching.

These devices have integrated protection against excessive voltage such as electrostatic discharges.

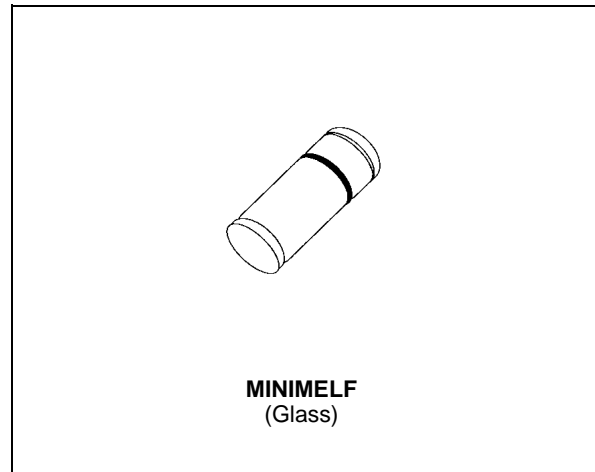

ABSOLUTE RATINGS (limiting values)

Symbol	Parameter		TMMBAT47	TMMBAT48	Unit
V_{RRM}	Repetitive Peak Reverse Voltage		20	40	V
I_F	Forward Continuous Current	$T_1 = 25\text{ }^\circ\text{C}$	350		mA
I_{FRM}	Repetitive Peak Forward Current	$t_p \leq 1\text{ s}$ $\delta \leq 0.5$	1		A
I_{FSM}	Surge non Repetitive Forward Current	$t_p = 10\text{ ms}$	7.5		A
		$t_p = 1\text{ s}$	1.5		
P_{tot}	Power Dissipation	$T_1 = 25\text{ }^\circ\text{C}$	330		mW
T_{stg} T_j	Storage and Junction Temperature Range		- 65 to 150		$^\circ\text{C}$
			- 65 to 125		$^\circ\text{C}$
T_L	Maximum Temperature for Soldering during 15s		260		$^\circ\text{C}$

THERMAL RESISTANCE

Symbol	Test Conditions	Value	Unit
$R_{th(j-l)}$	Junction-leads	300	$^\circ\text{C/W}$

ELECTRICAL CHARACTERISTICS
STATIC CHARACTERISTICS

Symbol	Test Conditions			Min.	Typ.	Max.	Unit
V _{BR}	T _j = 25°C	I _R = 10μA	TMMBAT47	20			V
	T _j = 25°C	I _R = 25μA	TMMBAT48	40			
V _F *	T _j = 25°C	I _F = 0.1mA	All Types			0.25	V
	T _j = 25°C	I _F = 1mA				0.3	
	T _j = 25°C	I _F = 10mA				0.4	
	T _j = 25°C	I _F = 30mA	TMMBAT47			0.5	
	T _j = 25°C	I _F = 150mA				0.8	
	T _j = 25°C	I _F = 300mA				1	
	T _j = 25°C	I _F = 50mA	TMMBAT48			0.5	
	T _j = 25°C	I _F = 200mA				0.75	
	T _j = 25°C	I _F = 500mA				0.9	
I _R *	T _j = 25°C	V _R = 1.5V	All Types			1	μA
	T _j = 60°C					10	
	T _j = 25°C	V _R = 10V	TMMBAT47			4	
	T _j = 60°C					20	
	T _j = 25°C	V _R = 20V				10	
	T _j = 60°C					30	
	T _j = 25°C	V _R = 10V	TMMBAT48			2	
	T _j = 60°C					15	
	T _j = 25°C	V _R = 20V				5	
	T _j = 60°C					25	
	T _j = 25°C	V _R = 40V				25	
	T _j = 60°C					50	

DYNAMIC CHARACTERISTICS

Symbol	Test Conditions			Min.	Typ.	Max.	Unit	
C	T _j = 25°C	V _R = 0V	f = 1MHz		20		pF	
	T _j = 25°C	V _R = 1V			12			
t _{rr}	T _j = 25°C	I _F = 10mA	V _R = 1V	i _{rr} = 1mA	R _L = 100Ω		10	ns

* Pulse test: t_p ≤ 300μs δ < 2%.

Figure 1. Forward current versus forward voltage at different temperatures (typical values).

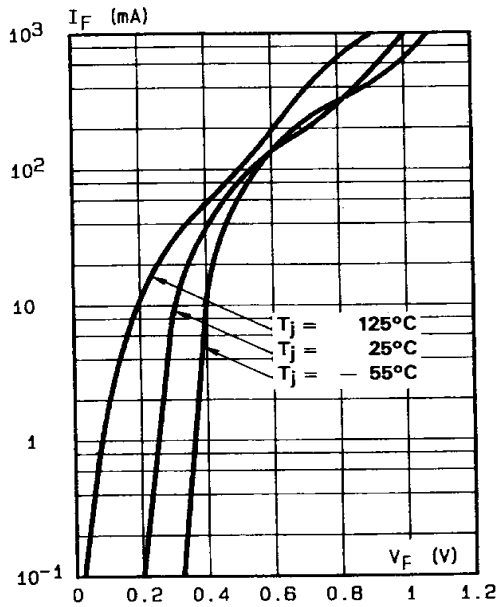

Figure 2. Forward current versus forward voltage (typical values).

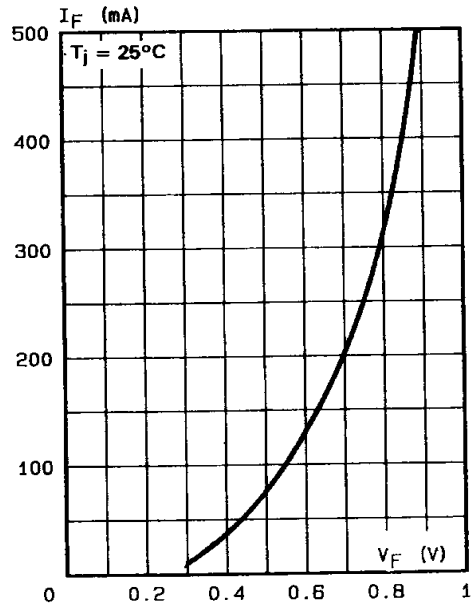

Figure 3. Reverse current versus junction temperature.

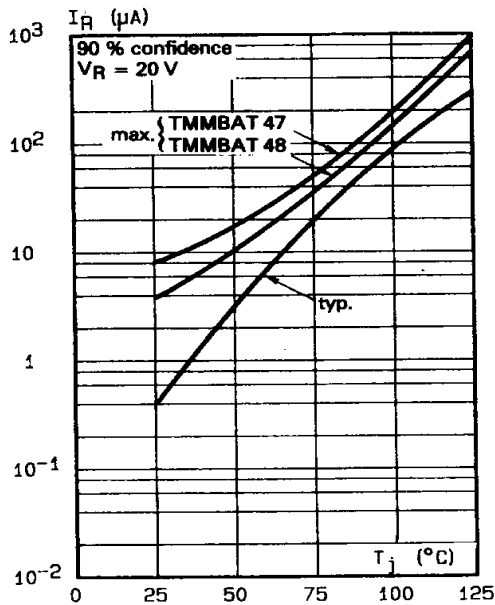

Figure 4. Reverse current versus continuous reverse voltage (typical values).

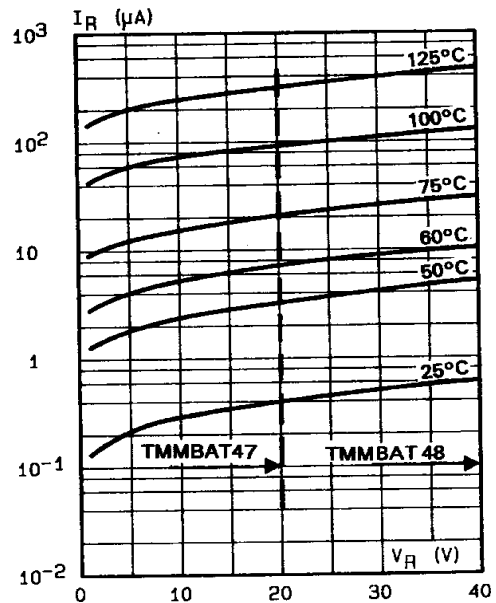
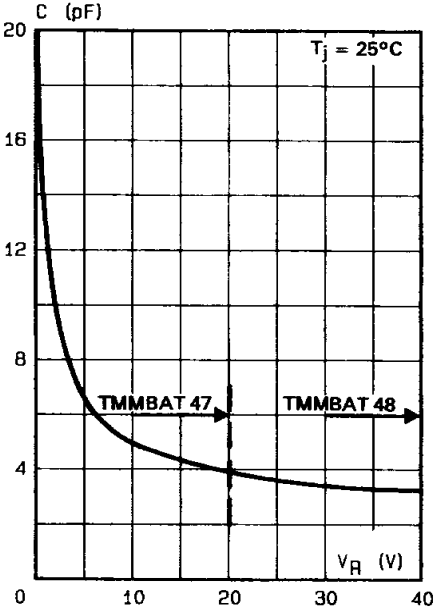

Figure 5. Capacitance C versus reverse applied voltage V_R (typical values).



PACKAGE MECHANICAL DATA

FOOT PRINT DIMENSIONS (Millimeter)

MINIMELF Glass

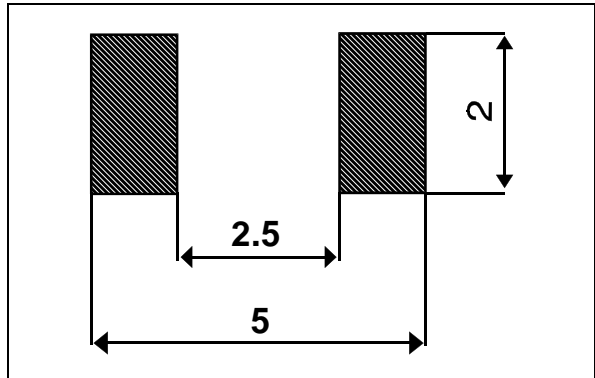
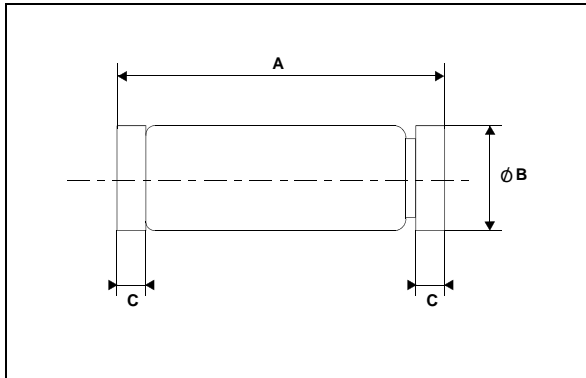

REF.	DIMENSIONS			
	Millimeters		Inches	
	Min.	Max.	Min.	Max.
A	3.3	3.6	0.130	0.142
B	1.59	1.62	0.063	0.064
C	0.4	0.5	0.016	0.020

Marking: ring at cathode end.
Weight: 0.05g

Information furnished is believed to be accurate and reliable. However, SGS-THOMSON Microelectronics assumes no responsibility for the consequences of use of such information nor for any infringement of patents or other rights of third parties which may result from its use. No license is granted by implication or otherwise under any patent or patent rights of SGS-THOMSON Microelectronics. Specifications mentioned in this publication are subject to change without notice. This publication supersedes and replaces all information previously supplied. SGS-THOMSON Microelectronics products are not authorized for use as critical components in life support devices or systems without express written approval of SGS-THOMSON Microelectronics.

© 1994 SGS-THOMSON Microelectronics - Printed in Italy - All rights reserved.

SGS-THOMSON Microelectronics GROUP OF COMPANIES

Australia - Brazil - France - Germany - Hong Kong - Italy - Japan - Korea - Malaysia - Malta - Morocco - The Netherlands - Singapore - Spain - Sweden - Switzerland - Taiwan - United Kingdom - U.S.A.