

DATA SHEET

TDA9614H

Audio processor for VHS hi-fi
and linear audio

Preliminary specification
File under Integrated Circuits, IC02

1995 Mar 21

Philips Semiconductors



PHILIPS

Audio processor for VHS hi-fi and linear audio

TDA9614H

CONTENTS	12	TEST AND APPLICATION INFORMATION	
1	FEATURES	12.1	RAF I/O (pin 12)
2	GENERAL DESCRIPTION	12.2	RCCOL, RCCOR, RBPF and RFIX (pins 59, 53, 55 and 49)
3	ORDERING INFORMATION	13	PACKAGE OUTLINE
4	BLOCK DIAGRAM	14	SOLDERING
5	PINNING	14.1	Plastic quad flat packages
6	FUNCTIONAL DESCRIPTION	14.1.1	By wave
6.1	Audio I/O switching	14.1.2	By solder paste reflow
6.1.1	Input Select (InputSel)	14.1.3	Repairing soldered joints (by hand-held soldering iron or pulse-heated solder tool)
6.1.2	Normal Select (NormSel)	15	DEFINITIONS
6.1.3	Volume L/R; AGC	16	LIFE SUPPORT APPLICATIONS
6.1.4	Audio FM Output Mute (AFOMute); Normal Output Mute (NOMute)	17	PURCHASE OF PHILIPS I ² C COMPONENTS
6.1.5	Output Select (OutSel)		
6.1.6	RF Converter Mute (RFCMute)		
6.1.7	Line Select (LineSel)		
6.1.8	Decoder Select (DecodeSel)		
6.1.9	Headphone Select (HPSel)		
6.1.10	Headphone volume		
6.1.11	DC Select (DCSel)		
6.2	Linear audio circuits		
6.2.1	Record/loop-through		
6.2.2	Playback		
6.3	Audio FM circuits		
6.3.1	Record/loop-through		
6.3.2	Playback		
6.3.3	Automatic calibration		
6.3.4	PAL/NTSC mode		
6.4	I ² C-bus		
6.5	Power-On Reset (POR); derived from digital supply voltage V_{DD}		
6.6	Control byte		
6.7	Main select byte		
6.8	Secondary select byte		
6.9	Left/Right (L/R) volume byte		
6.10	Headphone volume byte		
6.11	Install byte		
6.12	Test byte		
6.13	Read byte		
7	LIMITING VALUES		
8	THERMAL CHARACTERISTICS		
9	DC CHARACTERISTICS		
10	AC CHARACTERISTICS		
10.1	Record audio FM mode		
10.2	Record linear audio mode		
10.3	Playback Audio FM mode		
10.4	Playback linear audio		
11	INTERNAL CIRCUITRY		



Audio processor for VHS hi-fi and linear audio

TDA9614H

1 FEATURES

- All functions controlled by I²C-bus
- No adjustments needed by use of auto-calibration circuit
- Integrated Bandpass Filters (BPFs)
- Low-noise Phase-Locked Loop (PLL) FM (de)modulator
- Low-distortion sample-and-hold switching noise suppressor
- Integrated HF Low-Pass Filter (LPF) and summator
- Integrated audio LPF
- 5 stereo inputs (left and right channel):
 - TUNL and TUNR
 - CINL and CINR
 - EXT1L and EXT1R
 - EXT2L and EXT2R
 - EXT3L and EXT3R
- Additional mono input: Second Audio Program (SAP)
- Independent Input/Output (I/O) selections and 2nd line output
- Linear audio
- DC output for VU meter drive
- Direct headphone drive
- RF converter output with overload Automatic Gain Control (AGC)
- Integrated standby mode for low current consumption
- E-E performance (record + playback):
 - Total Harmonic Distortion (THD): 0.05% (–8 dBV, 1 kHz)
 - linearity error: 0.1 dB (–88 dBV, 1 kHz)
 - noise: –93 dBV (20 Hz to 20 kHz).

2 GENERAL DESCRIPTION

The TDA9614H is an audio processing IC for VHS hi-fi and linear audio, digitally controlled via the I²C-bus. The FM (de)modulator and peak noise reduction functions are highly integrated, resulting in few external components and no external adjustments.

In addition special functions for audio mixing, dubbing and descrambling have been implemented.

3 ORDERING INFORMATION

TYPE NUMBER	PACKAGE		
	NAME	DESCRIPTION	VERSION
TDA9614H	QFP64 ⁽¹⁾	plastic quad flat package; 64 leads (lead length 1.95 mm); body 14 × 20 × 2.8 mm	SOT319-2

Note

1. When using IR reflow soldering it is recommended that the Drypack instructions in the "Quality Reference Handbook" (order number 9398 510 63011) are followed.

Audio processor for VHS hi-fi and linear audio

TDA9614H

4 BLOCK DIAGRAM

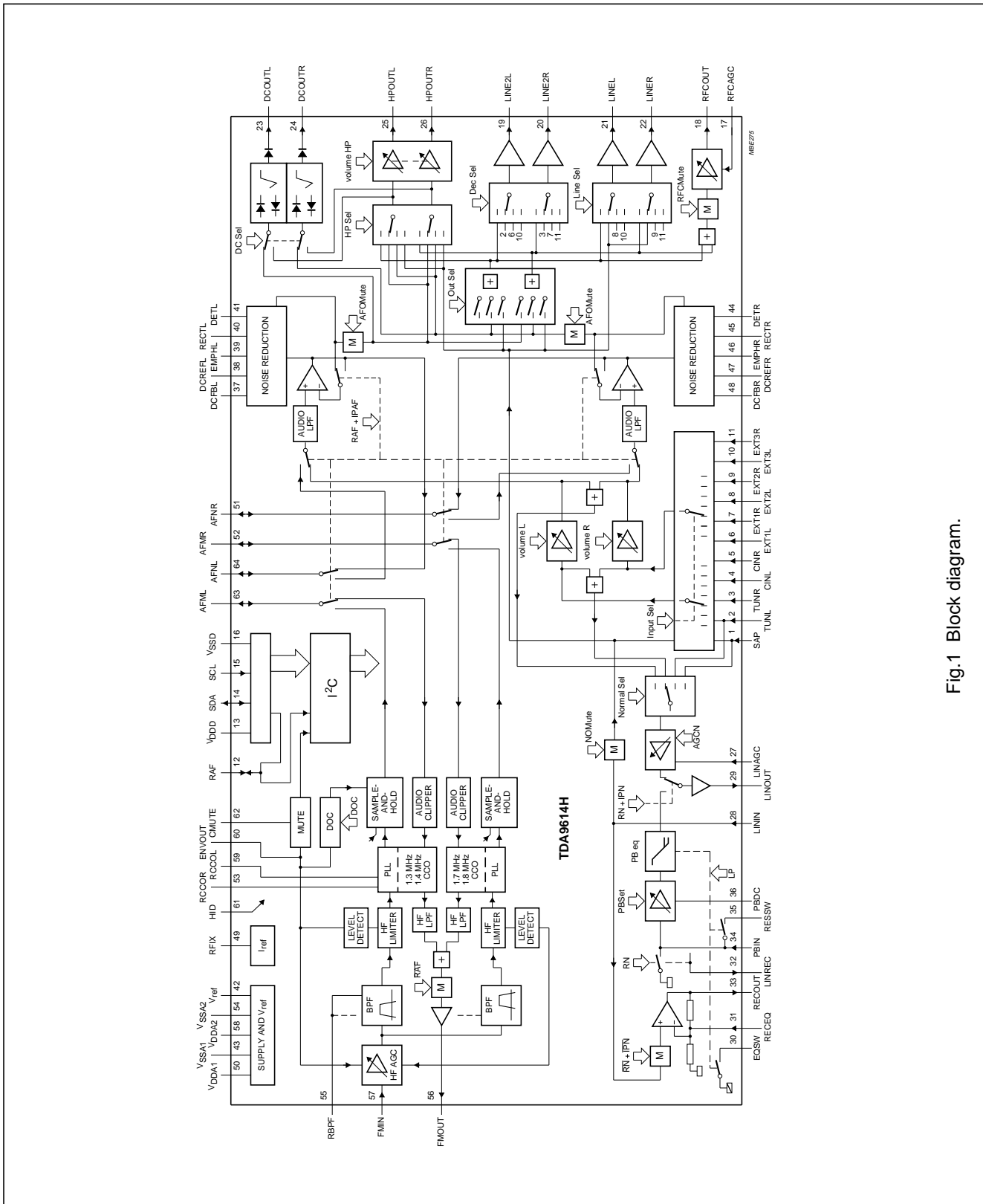

Fig.1 Block diagram.

Audio processor for VHS hi-fi and linear audio

TDA9614H

5 PINNING

SYMBOL	PIN	DESCRIPTION
SAP	1	Second Audio Program (SAP) input.
TUNL	2	Left channel tuner input.
TUNR	3	Right channel tuner input.
CINL	4	Left channel cinch input.
CINR	5	Right channel cinch input.
EXT1L	6	Left channel external 1 input.
EXT1R	7	Right channel external 1 input.
EXT2L	8	Left channel external 2 input.
EXT2R	9	Right channel external 2 input.
EXT3L	10	Left channel external 3 input.
EXT3R	11	Right channel external 3 input.
RAF	12	Record/playback switch drive output for head amplifier control or input for overruling the I ² C-bit RAF.
V _{DD}	13	Digital supply voltage for I ² C-bus (+5 V).
SDA	14	Data input/output for I ² C-bus.
SCL	15	Clock input for I ² C-bus.
V _{SS}	16	Digital ground for I ² C-bus.
RFCAGC	17	RF converter AGC-time constant.
RFCOUT	18	RF converter drive output.
LINE2L	19	Line 2 left output (e.g. decoder output).
LINE2R	20	Line 2 right output (e.g. decoder output).
LINEL	21	Line output left.
LINER	22	Line output right.
DCOUTL	23	VU meter drive output left.
DCOUTR	24	VU meter drive output right.
HPOUTL	25	Headphone drive output left.
HPOUTR	26	Headphone drive output right.
LINAGC	27	Linear audio AGC-time constant.
LININ	28	Audio input for linear audio to REC equalizer and output select.
LINOUT	29	Audio output from AGC or PB equalizer.
EQSW	30	Long Play (LP) equalization switch; 15 Ω on resistance and 150 kΩ input impedance.
RECEQ	31	Linear audio recording amplifier negative feedback input for connecting a record equalization network.
LINREC	32	Digital output controlled by I ² C-bit RN; can be used to drive an external (high voltage) head switch and possibly the bias oscillator.
RECOUT	33	Linear audio recording amplifier output.
PBIN	34	Linear audio playback amplifier input; during playback the impedance is 100 kΩ; during record the impedance is 7 Ω.
RESSW	35	Long Play equalization switch 50 Ω on and 150 kΩ off impedance to PBIN.
PBDC	36	Linear audio playback amplifier DC decoupling.

Audio processor for VHS hi-fi and linear audio

TDA9614H

SYMBOL	PIN	DESCRIPTION
DCFBL	37	DC feedback left.
DCREFL	38	DC reference left.
EMPHL	39	Total emphasis left (240 to 20 μ s).
RECTL	40	Rectifier DC decoupling left.
DETL	41	Attack/recovery timing left.
V _{ref}	42	Noise filtering of 3.8 V reference voltage (external capacitor required for filtering).
V _{SSA1}	43	Analog ground 1 for LF circuits.
DETR	44	Attack/recovery timing right.
RECTR	45	Rectifier DC decoupling right.
EMPHR	46	Total emphasis right (240 to 20 μ s).
DCREFR	47	DC reference right.
DCFBR	48	DC feedback right.
RFIX	49	Fixed bias current generation circuit by using an external 180 k Ω resistor to ground.
V _{DDA1}	50	Analog supply voltage 1 for LF circuits (+12 V).
AFNR	51	Audio output from noise reduction of right channel (record and loop-through) or audio input for noise reduction of right channel (playback).
AFMR	52	Audio input for audio clipper of right channel (record and loop-through) or audio output from sample-and-hold (playback).
RCCOR	53	Voltage-to-current transfer for right channel oscillator by means of an external resistor to ground.
V _{SSA2}	54	Analog ground 2 for HF circuits.
RBPF	55	Bias current generation for the internal band-pass filters by means of an external resistor to ground.
FMOUT	56	FM output.
FMIN	57	FM input.
V _{DDA2}	58	Analog supply voltage 2 for HF circuits (+5 V).
RCCOL	59	Voltage-to-current transfer for left channel oscillator by means of an external resistor to ground.
ENVOUT	60	Level detector output (external capacitor required for filtering).
HID	61	Head Identification Pulse (HID) input for sample-and-hold circuits.
CMUTE	62	Mute timing (external capacitor required for playback mute).
AFML	63	Audio input for audio clipper of left channel (record and loop-through) or audio output from sample-and-hold circuit of left channel (playback).
AFNL	64	Audio output from noise reduction of left channel (record and loop-through) or audio input for noise reduction of left channel (playback).

Audio processor for VHS hi-fi
and linear audio

TDA9614H

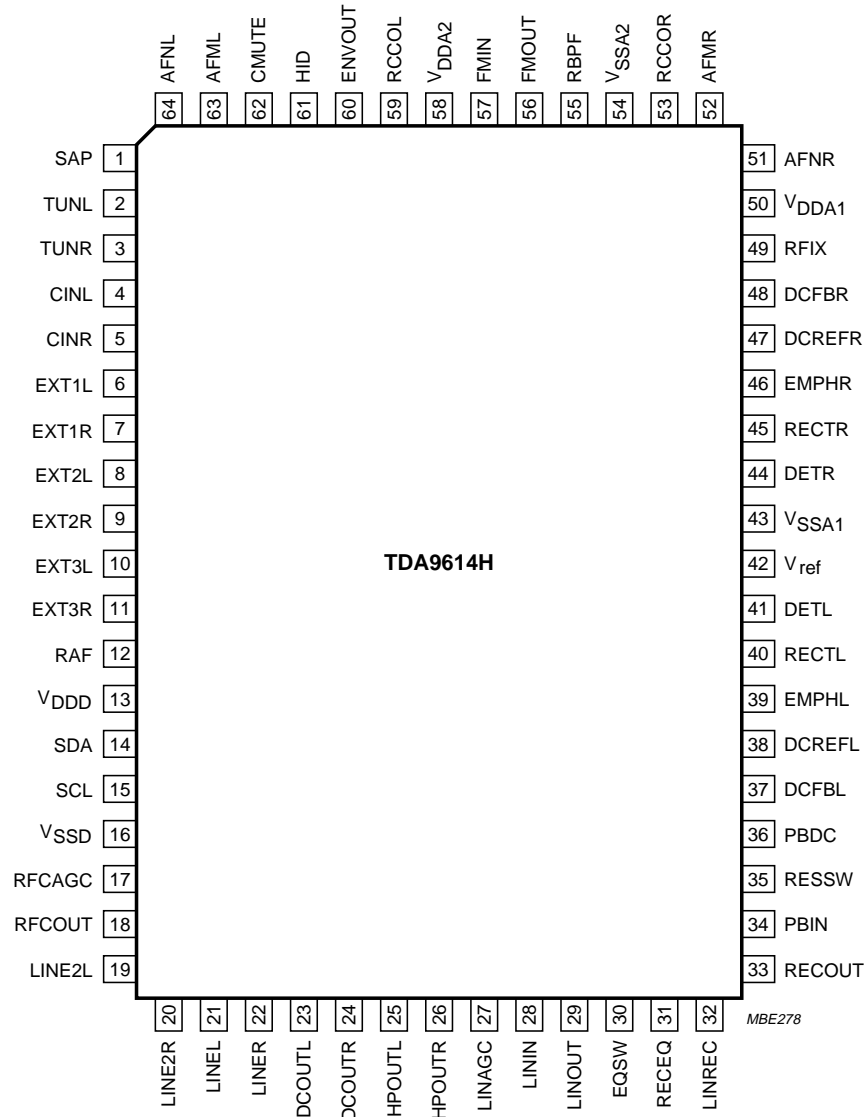

Fig.2 Pin configuration.

Audio processor for VHS hi-fi and linear audio

TDA9614H

6 FUNCTIONAL DESCRIPTION

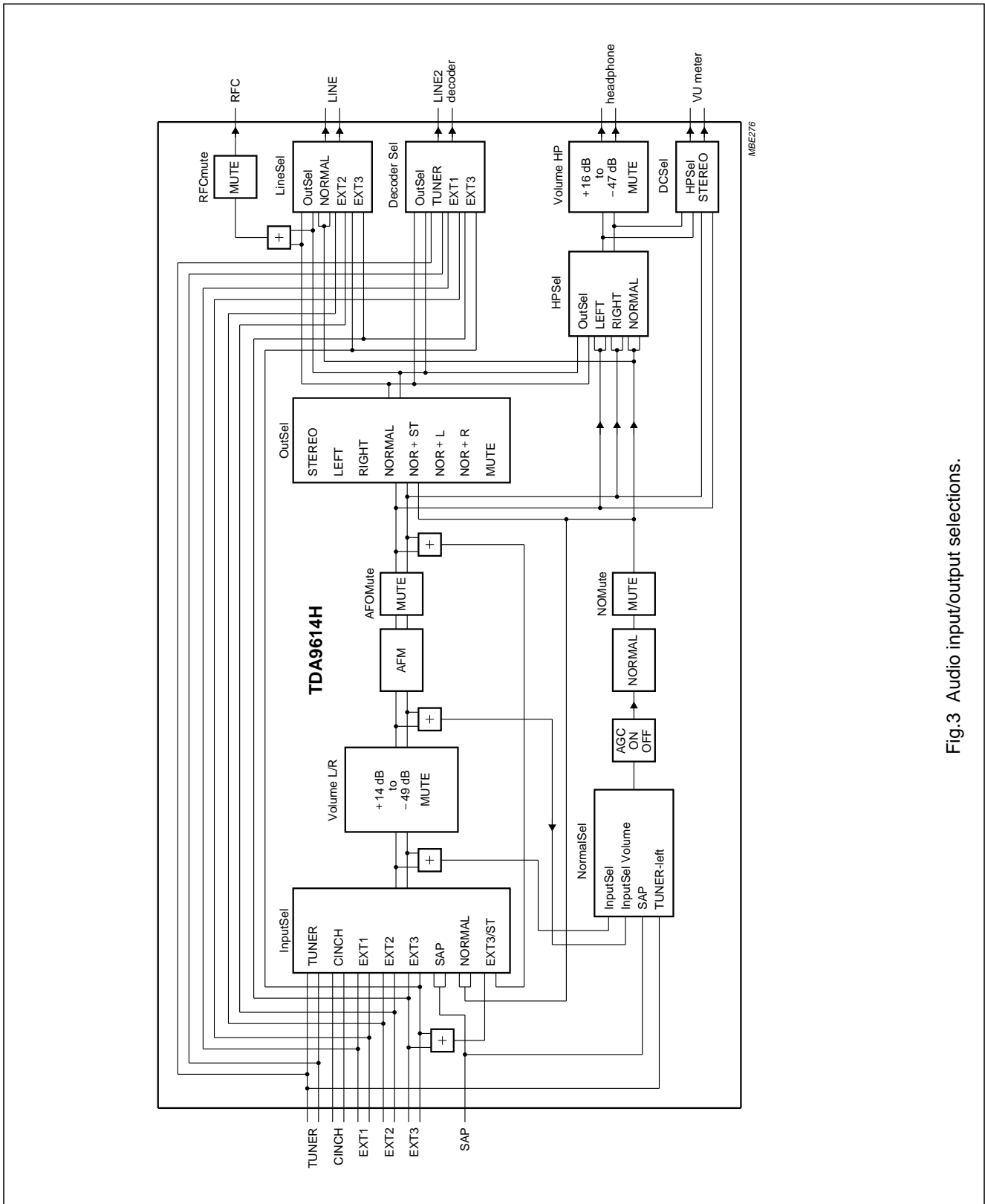

Fig.3 Audio input/output selections.

Audio processor for VHS hi-fi and linear audio

TDA9614H

6.1 Audio I/O switching

6.1.1 INPUT SELECT (INPUTSEL)

For the audio FM circuitry eight different audio signals can be selected. The selection made here for hi-fi is also available for the linear audio circuitry.

1. TUNER (stereo input; internal tuner of VCR).
2. CINCH (stereo input; connection to hi-fi set).
3. EXT1 (stereo input; TV SCART1).
4. EXT2 (stereo input; decoder, 2nd VCR SCART2).
5. EXT3 (stereo input; front CINCH for e.g. camcorder).
6. SAP (mono input; 'Second Audio Program' audio carrier for NTSC or conventional FM carrier with NICAM reception).
7. NORMAL (linear audio; [playback] signal of linear audio).
When inserting a new video signal in an old audio/video recording the hi-fi audio track is erased. This setting can keep the current audio available on the hi-fi track by copying the (playback) linear audio signal to the hi-fi track during video insert.
8. EXT3/ST (input mix; mono EXT3 on left, mono hi-fi on right channel).

For linear audio use see Section 6.1.2.

6.1.2 NORMAL SELECT (NORMSEL)

For linear audio four settings can be selected:

1. INPUTSEL (mono signal from input select).
This is the 'standard' setting. The signal source selected with the input select is led to the linear audio circuit. The linear audio AGC should be switched on.
2. VOLUME (mono signal from [hi-fi] volume control).
The signal source selected with the input select has now volume control, the linear audio AGC should be switched off. This setting is for use with 'audio dubbing': inserting a new audio signal on the linear track in an old audio/video recording. A special audio dubbing feature is now possible by selecting 'input mix' EXT3/ST in the input select. This setting enables us to use the VCR as a mixer console: an audio source connected to EXT3 (front CINCH) can be adjusted and mixed together with the original hi-fi playback signal, using the left (EXT3) and right (hi-fi playback) volume controls.

3. SAP (SAP input).

This setting enables simultaneous recording of the NTSC SAP signal on the linear track and TUNER stereo on the audio FM track. When receiving a NICAM audio signal, the linear audio can be used as a 'backup' track when received television signals are weak.

4. TUNER LEFT (left channel [language 1] of TUNER input).

When receiving dual language transmissions the main language (language 1) can be recorded on linear audio. Note that if the SAP input is not used it can be connected to the right TUNER channel, enabling language selection for linear audio.

6.1.3 VOLUME L/R; AGC

The volume controls are mainly intended for level adjusting of the audio signals to be recorded on the hi-fi track, however using the 'VOLUME' setting in the Normal Select it can also be used to control linear audio. The volume controls have a control range of +14 dB to -49 dB in 1 dB steps and a full mute. Because the volume controls are I²C-bus controlled their actual behaviour is defined by the VCR's software. For instance user control can be 'volume only', 'left + right', 'volume + balance' or the setting can be defined by a 'digital AGC' software loop using the signals at the DC (VU meter) outputs.

The linear audio level can be controlled by an AGC circuit, which can be switched off when desired. In most cases the AGC should be used at all settings of the Normal Select except for 'VOLUME'.

6.1.4 AUDIO FM OUTPUT MUTE (AFOMUTE); NORMAL OUTPUT MUTE (NOMUTE)

The audio output signal of the audio FM circuit can be muted with AFOMute, the linear output signal can be muted using NOMute. If one of these signals is not used as an output (or input) signal it is best muted to further minimize crosstalk.

6.1.5 OUTPUT SELECT (OUTSEL)

This block is the 'main' output select function, possibly functional on all outputs. Each output however has some means to override this selection for its own output signal, to implement extra features. Eight selections are possible and they are shown in Table 1.

Audio processor for VHS hi-fi and linear audio

TDA9614H

Table 1 Output select possibilities

SELECTION	REMARK	DESCRIPTION
STEREO ⁽¹⁾	hi-fi stereo	audio FM output signal left and right channel
LEFT	hi-fi left	audio FM output signal left channel (language 1)
RIGHT	hi-fi right	audio FM output signal right channel (language 2)
NORMAL	linear audio	linear audio
NOR + ST	linear and hi-fi	mix of audio FM stereo and linear audio
NOR + L	linear and left	mix of audio FM left channel and linear audio
NOR + R	linear and right	mix of audio FM right channel and linear audio
MUTE	mute	

Note

- STEREO is the 'standard' setting, LEFT and RIGHT are for language selection. Using the tuner as input or output signal (record or loop-through of audio FM) the VCR can automatically switch from stereo to left (language 1) when a 'dual language' transmission is received. If the VCR is in playback mode and no hi-fi track is present (checking bit AFOM via the I²C-bus or using the level at pin 11) the VCR can switch the output select to NORMAL (or let the IC do this automatically by setting bit AUTN). If a hi-fi track is present the user may want to switch to LEFT and RIGHT if the recording made was a 'dual language' recording.

Furthermore the user may want to switch from a hi-fi selection to NORMAL, e.g. when a complete audio remix has been created on the linear track using 'audio dubbing' (see Section 6.7). 'Audio dubbing' can also be used to re-record the linear track with e.g. only commentary. Combined playback of this commentary together with the original hi-fi sound is then possible by means of a mix mode.

6.1.6 RF CONVERTER MUTE (RFCMUTE)

The RFC output is a mono output derived from the output select, its output signal can be muted.

6.1.7 LINE SELECT (LINESEL)

The line output select is normally connected to both CINCH (hi-fi set) and television (SCART1). Normally the audio signal from the output select will be available at this output, but three extra selections are possible and they are shown in Table 2.

Table 2 Extra line select possibilities

SELECTION	DESCRIPTION
NORMAL	linear audio, useful for monitoring during 'audio dubbing'
EXT2 ⁽¹⁾	audio from input EXT2
EXT3 ⁽²⁾	audio from input EXT3

Notes

- A signal from a source at EXT2 (laser disc or second VCR) can be connected to a television set at line out. Because this is a direct connection from the input to the line output buffers it is fully independent of any mode setting of the IC. Connection of a 'Pay-TV' decoder box to EXT2 and using this selection together with selecting EXT1 in the decoder select enables combined use of the decoder box by both TV and VCR. In Europe, use of the SCART connector 'status line' can automatize this switching.
- Direct audio connection from input EXT3. If the line 2 outputs and EXT3 inputs are not used for external connections a built-in karaoke unit or sound processor can be inserted between line 2 and EXT3.

Audio processor for VHS hi-fi and linear audio

TDA9614H

6.1.8 DECODER SELECT (DECODESEL)

The line 2 output is normally connected to a decoder box or e.g. a second VCR (SCART2). Normally the audio signal from the output select will be available at this output, but three extra selections are shown in Table 3.

Table 3 Extra decoder select possibilities

SELECTION	DESCRIPTION
TUNER ⁽¹⁾	audio from input TUNER
EXT1 ⁽²⁾	audio from input EXT1
EXT3	audio from input EXT3

Notes

- Enables the use of a decoder box (connected to line 2 [EXT2]) by the VCR.
- Decoder box connection to television set (See Section 6.1.7).

6.1.9 HEADPHONE SELECT (HPSEL)

The headphone output will normally carry the output select signal, however three more selections are possible and shown in Table 4.

Table 4 Extra headphone select possibilities

SELECTION	DESCRIPTION
LEFT ⁽¹⁾	left hi-fi channel
RIGHT ⁽¹⁾	right hi-fi channel
NORMAL	linear audio, useful for monitoring the recording by 'audio dubbing'

Note

- The selections LEFT and RIGHT make it possible to select a different language for the headphone as for the line outputs. A possible implementation is to invert always a language selection made at the output select.

6.1.10 HEADPHONE VOLUME

The headphone volume control has a control range of +16 dB to -47 dB in 1 dB steps and a full mute.

6.1.11 DC SELECT (DCSEL)

The VU meter output is normally connected to the headphone select, but can also be switched to STEREO (hi-fi stereo, before the output select). When using the VU meter output signal to implement a 'digital AGC' (read the level at the DC output, and adjust the VOLUME L/R controls accordingly) it is necessary to have information of

both hi-fi audio channels, independent from the setting of output or headphone select. For this mode the selection STEREO can be made.

6.2 Linear audio circuits

6.2.1 RECORD/LOOP-THROUGH

The signal selected with the normal select can be level controlled in the AGC block. If wanted this AGC can be switched off using bit AGCN. The audio signal is thereafter DC decoupled using a capacitor between pin 29 (LINOOUT) and pin 28 (LININ).

From here on the signal goes to the output select and (in the event of record mode) to the record equalizer. The record equalizer is a non-inverting amplifier with a gain of +12 dB, consisting of an opamp with feedback resistors, and acts as a pre-correction filter for the tape and head characteristics. The inverting input of the opamp is connected to pin 31 (RECEQ), its output to pin 33 (RECOU). The circuit externally connected between pin 31 and ground defines the transfer of the record

equalizer with equation: $A = 3.98 \times \frac{(1200 + Z)}{Z}$

Where: Z is the complex impedance of the external circuit.

Two equalizings can be used, switching additional circuitry to ground with pin 30 (EQSW) in long play or extended play (I²C-bus: LP = 1).

Instead of the hi-fi circuit, linear audio has two loop-through modes:

- Loop-through playback
- Loop-through record.

The only difference between Loop-through record and record is the RECOU output, which is muted.

The LINREC output (pin 32) is used to drive the external high-voltage switch and possibly the bias oscillator. The LINREC voltage has a small internal delay to be non-overlapping with the internal switching to playback mode. This ensures that no bias voltage will appear at the PBIN input while the IC is in playback mode.

6.2.2 PLAYBACK

The signal coming from the head is amplified and can be level controlled in 16 steps of 1 dB. This setting can be used to adjust for spread or nominal difference in head output level. Afterwards, the signal is frequency corrected in the playback equalizer. This equalizer includes the two standard VHS equalizing settings of 3180 and 120 μ s

Audio processor for VHS hi-fi and linear audio

TDA9614H

(standard play: LP = 0) and 3180 and 170 μ s (Long Play: LP = 1).

The signal is DC decoupled and routed to the output select via pins 29 and 28. When switching to or from playback the signal should be muted shortly using the Normal Output Mute (NOM) to prevent audible clicks caused by offset differences of the playback amplifier and AGC.

6.3 Audio FM circuits

6.3.1 RECORD/LOOP-THROUGH

After low-pass filtering and signal compression in the Noise Reduction (NR) the audio signal is available at AFNL and AFNR. Through a DC-decoupling capacitor the compressed audio signal is fed to an audio clipper at AFML and AFMR. Subsequently, the audio signal is FM-modulated on a RF-carrier using an integrated current-controlled oscillator (CCO). Each CCO (L and R) requires an external resistor (RCCOL/R) for temperature stability. Through automatic calibration both the oscillator centre frequency and FM-deviation are adjusted. After low-pass filtering and summation of the two RF-carriers, the FM signal is available at FMOUT during record. During loop-through the FMOUT pin is inactive.

The RAF pin reflects the status of the RAF-bit when it is used as output pin. In this case it is meant to switch the head amplifier between record and playback position. It can also be used as an input pin to overrule the RAF-bit thereby forcing the IC in record or playback/loop-through position.

6.3.2 PLAYBACK

The two FM modulated RF carriers, presented at FMIN, are fed to an AGC circuit. The AGC operates on the peak level of the added BPF output signals. As a result, the input signal of the BPFs is kept constant for FMIN voltages >30 mV (RMS value) both carriers added. In this way the dynamic range of the integrated BPFs is optimally used over a large input signal range. Subsequently, the RF carriers are bandpass filtered using two integrated BPFs. These bandpass filters are automatically calibrated as described in Section 6.3.3. An external resistor (RBPF) is required for temperature stability.

The filtered input signals are fed to a limiter. The limiter output signal is demodulated by means of a PLL demodulator. The LF audio signal is fed through a sample-and-hold circuit to suppress head-switching noise. The demodulated audio is available at AFML and AFMR. Through a decoupling capacitor the audio signal is applied to an audio low-pass filter at AFNL and AFNR. The

low-pass filtered audio signal is expanded in the noise reduction.

If the left channel carrier at FMIN falls below the mute level of 4.2 mV (RMS value) the audio signal is muted in front of the low-pass filter. This is achieved by comparing the left channel level detector signal with an internal reference. The mute timing is fixed by a capacitor at the CMUTE pin. If the level at CMUTE rises above a certain threshold, the PBMUTE bit is set. This will mute the audio signal. If bit AUTN has been set, the output selection will automatically switch to NORMAL mode. The left channel level detector output is also available at pin ENVOUT. An AGC correction voltage is added at this pin, such that the ENVOUT voltage indicates the left channel FM-carrier level even within the AGC-range. The ENVOUT voltage can be used for auto-tracking of the FM-audio heads.

In the event of drop-outs in the incoming FM signal, the left channel level detector is also used to activate the sample-and-hold. This drop-out cancellation is only active if bit DOC has been set.

6.3.3 AUTOMATIC CALIBRATION

By means of bit CALS the two integrated oscillators and bandpass filters can be calibrated in Loop-Through (LT) or record (REC) mode. Normally this will be done after start-up of the VCR. After setting of bit CALS the calibration procedure is automatically executed as shown in Fig.4. The calibration starts at the first negative edge of HID after CALS has been set. During the LOW period of HID (20 ms for PAL) the number of oscillator cycles is compared to a certain value stored in a Read Only Memory (ROM).

Therefore, the final oscillator frequency is proportional to the inverse of the HID LOW-time. This means that an error of 1 μ s in the HID LOW-time will result in an additional frequency error of approximately 100 Hz. The maximum number of required HID cycles for one complete oscillator calibration is six, which is equal to 240 ms.

After both oscillators have been calibrated the bandpass filters are calibrated using the right channel oscillator as reference frequency generator (1.6 MHz for PAL). This will take <10 ms.

Bit CALR is set to 1 if the calibration has been executed successfully. CALR is 0 if:

- A Power-On Reset (POR) has occurred.
- The calibration is running.
- The initial oscillator and bandpass frequencies are too low or too high for a successful calibration.

Audio processor for VHS hi-fi and linear audio

TDA9614H

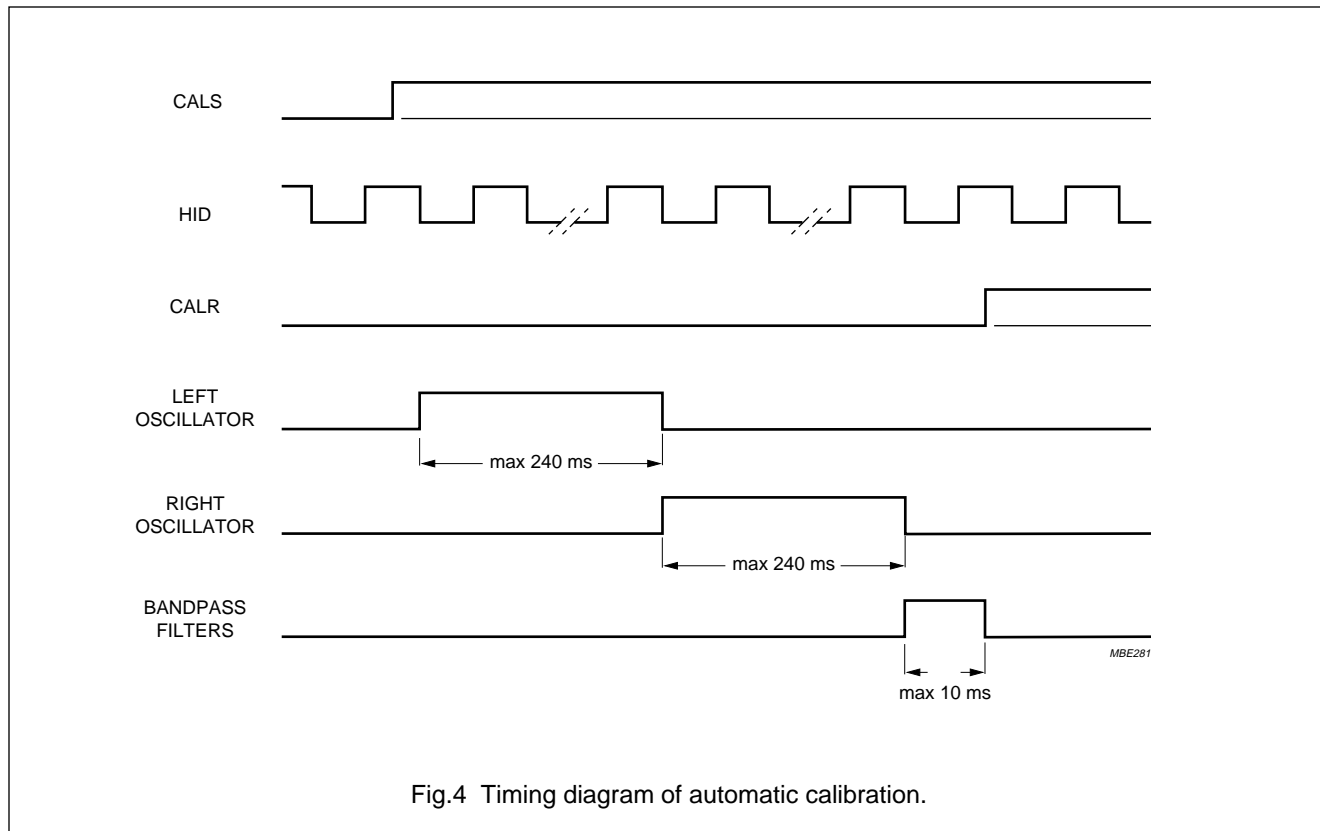

Fig.4 Timing diagram of automatic calibration.

If CALS is reset during CALR = 0, the calibration will be stopped if it was not finished yet. If required, a new calibration can be started using CALS.

WARNING: the IC should not be calibrated in a test or standby mode.

6.3.4 PAL/NTSC MODE

Depending on bit NTSC the IC is calibrated in PAL or NTSC mode using bit CALS. After an automatic calibration the oscillator frequencies can be switched between PAL and NTSC using bit NTSC. This centre frequency shift is done without automatic calibration. During playback (PB) or loop-through (LT) a change in bit NTSC will automatically calibrate the bandpass filters again. This will take <10 ms.

WARNING: A change of PB to REC, LT to REC and PAL to NTSC should not be combined in one transmitted byte. The PAL to NTSC transition should be preceded by the PB to REC or LT to REC transition.

6.4 I²C-bus

The TDA9614H is controlled via the 2-wire I²C-bus, in accordance with the I²C-bus specification. As slave receiver for programming there is one module address, with R/W bit = 0, a subaddress byte and eight data bytes. If more than one data byte follows the subaddress, these bytes are stored in the successive registers by the automatic address increment feature. As slave transmitter (R/W bit = 1) there is one read byte.

Audio processor for VHS hi-fi and linear audio

TDA9614H

Table 5 TDA9614H addresses and data bytes

NAME	ADDRESS							
	1	0	1	1	1	0	0	R/W
Slave address byte	1	0	1	1	1	0	0	R/W
Subaddress bytes 00 to 07	0	0	0	0	0	X ⁽¹⁾	X ⁽¹⁾	X ⁽¹⁾
Control byte (subaddress 00)	RAF	IPAF	AFOM	NTSC	RN	IPN	NOM	LP
Main select byte (subaddress 01)	IS2	IS1	IS0	NS1	NS0	OSL	OSR	OSN
Secondary select byte (subaddress 02)	HSL	HSR	DCS	RFCM	LOS1	LOS0	DOS1	DOS0
Left volume byte (subaddress 03)	0	VLM	VL5	VL4	VL3	VL2	VL1	VL0
Right volume byte (subaddress 04)	0	VRM	VR5	VR4	VR3	VR2	VR1	VR0
Headphone volume byte (subaddress 05)	0	VHM	VH5	VH4	VH3	VH2	VH1	VH0
Install byte (subaddress 06)	DEV1	DEV0	NPL3	NPL2	NPL1	NPL0	AUTN	DOC
Test byte (subaddress 07)	STBY	CALS	AGCN	TST4	TST3	TST2	TST1	TST0
Read byte (address B9)	CALR	PAFM	1	POR	1	0	1	1

Note

1. These bits determine the subaddress.

6.5 Power-On Reset (POR); derived from digital supply voltage V_{DD}

In the data byte descriptions [por] indicates the mode after POR. The status of the data bytes after POR is shown in Table 6.

Table 6 Status of data bytes after POR

DATA BYTE	ADDRESS							
	0	1	1	0	0	1	1	0
Control byte	0	1	1	0	0	1	1	0
Main select byte	0	0	0	0	0	1	1	0
Secondary select byte	1	1	0	0	0	0	0	0
Left volume byte	0	0	1	1	0	0	0	1
Right volume byte	0	0	1	1	0	0	0	1
Headphone volume byte	0	0	1	0	1	1	1	1
Install byte	0	1	0	1	1	1	0	1
Test byte	0	0	0	0	0	0	0	0

A POR occurrence is signalled by bit POR in the read byte (see Table 39).

Audio processor for VHS hi-fi and linear audio

TDA9614H

6.6 Control byte

Table 7 Bits of control byte

BIT	DESCRIPTION
RAF	Record Audio FM; see Table 8
IPAF	Inverse Playback Audio FM; see Table 8
AFOM	Audio FM Output Mute; see Table 9
NTSC	NTSC; television standard; see Table 10
RN	Record Normal; see Table 11
IPN	Inverse Playback Normal; see Table 11
NOM	Normal Output Mute; see Table 12
LP	Long Play mode; see Table 13

Table 8 Bits RAF and IPAF

RAF ⁽¹⁾	IPAF	MODE	DESCRIPTION
0	0	playback	NR and modem in playback mode
0	1	loop-through	NR in record mode; modem not active [por]
1	0	record ⁽²⁾	NR and modem in record mode
1	1	record ⁽²⁾	NR and modem in record mode

Notes

1. The RAF bit can be overruled externally by applying a low-ohmic voltage to the RAF I/O (pin 12) either logic 0 or logic 1 (0 or +5 V). The actual mode of the IC is determined by the level measured at this pin, enabling fast switching between record and playback/loop-through.
2. The two record modes are equal, only differing in their reaction to forcing RAF LOW at the RAF I/O pin; the status of the IPAF bit determines whether the IC is switched to the playback or loop-through mode.

Table 9 Bit AFOM

AFOM	MODE	DESCRIPTION
0	–	–
1	mute ⁽¹⁾	output from audio FM (NR) circuit is muted [por]

Note

1. Audio coming from the audio FM circuit is muted, either the signal from tape in playback or the loop-through signal in record or loop-through modes.

Table 10 Bit NTSC

NTSC	MODE	DESCRIPTION
0	PAL	modem and BPF set to PAL carrier frequencies [por]
1	NTSC	modem and BPF set to NTSC carrier frequencies

Audio processor for VHS hi-fi and linear audio

TDA9614H

Table 11 Bits RN and IPN

RN ⁽¹⁾	IPN	MODE	DESCRIPTION
0	0	playback	linear audio circuit in playback mode
0	1	loop-through P	linear audio circuit in loop-through mode (playback ready) [por]
1	0	loop-through R ⁽²⁾	linear audio circuit in loop-through mode (record ready)
1	1	record	linear audio circuit in record mode

Notes

1. Bit RN is output at LINREC (pin 32), which is used to drive an external (high voltage) head switch and possibly the bias oscillator. The two loop-through modes are equal in signal flow, however they differ in the state of the head switches (the internal switch at PBIN [pin 34] and the external head switch driven by pin LINREC).
2. Loop-through R is equal to record except for the RECOUT output (pin 33) which is muted.

Table 12 Bit NOM

NOM	MODE	DESCRIPTION
0	–	–
1	mute ⁽¹⁾	output from linear audio circuit is muted [por]

Note

1. Audio coming from the linear audio circuit is muted, either the signal from tape in playback or the loop-through signal in record or loop-through modes. To avoid clicks when changing the mode of the linear audio circuit to or from playback, the output should be muted shortly, using this bit.

Table 13 Bit LP

LP	MODE	DESCRIPTION
0	SP	Record and playback equalizing set for Standard Play [por]. Record equalization switch at EQSW (pin 30) and playback equalization switch at RESSW (pin 35) are open (high impedance). The internal playback equalizing is 3180 and 120 μ s. It can be changed to 2544 and 96 μ s by selecting test number 31 (see Section 6.12).
1	LP	Record and playback equalizing set for Long Play. Record equalization switch at EQSW (pin 30) and playback equalization switch at RESSW (pin 35) are closed. The internal playback equalizing is 3180 and 170 μ s. It can be changed to 2731 and 146 μ s by selecting test number 31 (see Section 6.12).

Audio processor for VHS hi-fi and linear audio

TDA9614H

6.7 Main select byte

Table 14 Bits of main select byte

BIT	DESCRIPTION
IS2 to IS0	Input Select 2 to Input Select 0; see Table 15
NS1 and NS0	Normal Select 1 and Normal Select 0; see Table 16
OSL	Output Select Left; see Table 17
OSR	Output Select Right; see Table 17
OSN	Output Select Normal; see Table 17

Table 15 Bits IS2 to IS0; note 1

IS2	IS1	IS0	MODE	SELECTED INPUT SOURCE
0	0	0	Tuner	TUNL and TUNR [por]
0	0	1	Cinch	CINL and CINR
0	1	0	Ext1	EXT1L and EXT1R (e.g. SCART1; TV connector)
0	1	1	Ext2	EXT2L and EXT2R (e.g. SCART2; decoder connector)
1	0	0	Ext3	EXT3L and EXT3R (e.g. front cinch)
1	0	1	SAP	additional mono input (SAP; pin 1)
1	1	0	Normal ⁽²⁾	output from linear audio (LININ; pin 28)
1	1	1	Dub Mix ⁽²⁾⁽³⁾	mixing of EXT3 input with hi-fi output signal

Notes

- With bits IS2 to IS0, the stereo input signal is selected which is led to the hi-fi processing. One out of five stereo sources can be selected. The five stereo inputs differ in their connectivity; with bits NS1 and NS0 tuner left (TUNL; pin 2) can be selected as linear audio input source, with bits LOS1 and LOS0 Normal, Ext2 and Ext3 are directly connectable to Line out and to DOS1 and DOS0 Tuner, Ext1 and Ext3 are directly connectable to decoder out (2nd Line Out).
- Remark:** when using the selections Normal or Dub Mix be aware of signal loops (which should be avoided) because this can lead to large audio oscillations.
- The selection Dub Mix is a special function in which a mono signal derived from the Ext3 inputs ($\frac{1}{2}$ EXT3L + $\frac{1}{2}$ EXT3R) is led to the left input and a mono signal derived from the audio FM output ($\frac{1}{2}$ L + $\frac{1}{2}$ R) is led to the right input channel. This function can be used for audio dubbing using the volume controls as a mixing desk.

Table 16 Bits NS1 and NS0; note 1

NS1	NS0	MODE	DESCRIPTION
0	0	Input	linear audio input source is equal to hi-fi input [por]
0	1	Volume	linear audio input source is equal to hi-fi input, inclusive volume control
1	0	SAP	additional mono input (SAP; pin 1) is selected
1	1	Tuner L	left channel of tuner input is selected

Note

- With bits NS1 and NS0 the input signal is selected for the linear audio circuit. When a stereo input source is selected, a mono signal is made by adding the left and right channel. Furthermore two independent selections can be made (the mono input SAP or the left channel of tuner e.g. for dual language). If in the volume mode the built-in AGC circuit is switched off by using bit AGCN, the audio level can be controlled by the left and right volume controls (VLx and VRx).

Audio processor for VHS hi-fi and linear audio

TDA9614H

Table 17 Bits OSL, OSR and OSN; note 1

OSL	OSR	OSN	MODE	DESCRIPTION
1	1	0	stereo	LEFT at left channel; RIGHT at right channel [por].
1	0	0	left	LEFT at both left and right channels.
0	1	0	right	RIGHT at both left and right channels.
0	0	0	mute	No selection.
1	1	1	mixed stereo	LEFT + NORMAL added at left channel; RIGHT + NORMAL added at right channel.
1	0	1	mixed left	LEFT + NORMAL added at both left and right channels.
0	1	1	mixed right	RIGHT + NORMAL added at both left and right channels.
0	0	1	normal	NORMAL (is linear audio) at both left and right channels.

Note

- The bits OSL, OSR and OSN provide eight output select functions. LEFT and RIGHT are the left and right hi-fi channels; NORMAL is the linear audio channel (LININ; pin 28). This selection is normally output at line out (LINEL and LINER), RFCOUT (pin 18), decoder out (LINE2L and LINE2R), headphone out (HPOUTL and HPOUTR) and DC out (DCOUTL and DCOUTR). However line out can be overruled by bits LOS1 and LOS0; decoder out can be overruled by bits DOS1 and DOS0, headphone out (and DC out) can be overruled by bits HSL and HSR and DC out can be overruled by bit DCS.

Remark: if AUTN = 1 (see Section 6.11) the output select modes stereo, left and right will be forced to normal as long as the audio FM circuit is in playback mode and the internal PB mute signal is generated (no hi-fi track on tape). The status of this internal mute signal can be read by bit PAFM (see Section 6.13).

6.8 Secondary select byte**Table 18** Bits of secondary select byte

BIT	DESCRIPTION
HSL	Headphone Select Left; see Table 19
HSR	Headphone Select Right; see Table 19
DCS	DC Select; see Table 20
RFCM	RFC Mute; see Table 21
LOS1 and LOS0	Line Output Select 1 and Line Output Select 0; see Table 22
DOS1 and DOS0	Decoder Output Select 1 and Decoder Output Select 0; see Table 23

Audio processor for VHS hi-fi and linear audio

TDA9614H

Table 19 Bits HSL and HSR

HSL	HSR	MODE	DESCRIPTION
1	1	outsel	Headphone signal set by the output selection [por].
1	0	left	LEFT at both headphone out left and right.
0	1	right	RIGHT at both headphone out left and right.
0	0	normal	NORMAL (is linear audio) at both headphone outputs.

Normally the headphone output signal is set by the output selection OSL, OSR and OSN (see Table 17). Furthermore three independent selections can be made: LEFT hi-fi channel, RIGHT hi-fi channel (language selection) and NORMAL (e.g. monitoring an audio dubbing recording). These headphone selections are also active for the VU meter output (DC out), unless bit DCS = 1.

Table 20 Bit DCS

DCS	MODE	DESCRIPTION ⁽¹⁾
0	headphone	DC output is set by Headphone Select [por].
1	stereo	DC output is hi-fi stereo.

Note

1. The signal at DC out (DCOUTL and DCOUTR; pins 23 and 24) is normally the signal which can be listened to by the headphone. For use in concepts with digital AGC (using the DC output signal to control the left and right volume settings), an independent selection to hi-fi stereo can be made.

Table 21 Bit RFCM

RFCM	MODE	DESCRIPTION ⁽¹⁾
0	–	[por]
1	mute ⁽¹⁾	RF converter output signal muted

Note

1. The audio signal at RF converter out (a mono version of the signal selected with the output select with overload AGC) can be independently muted.

Table 22 Bits LOS1 and LOS0; note 1

LOS1	LOS0	MODE	DESCRIPTION
0	0	Outsel	Line output selection is set by output select function [por].
0	1	Normal	Linear audio is connected to line output.
1	0	Ext2	Ext2 input is directly connected to line output.
1	1	Ext3	Ext3 input is directly connected to line output.

Note

1. With the line output select some special connections can be made overruling the output select (OSL, OSR and OSN), e.g. for connecting a decoder box (for a pay-TV channel) to a television set via the VCR.

Audio processor for VHS hi-fi and linear audio

TDA9614H

Table 23 Bits DOS1 and DOS0; note 1

DOS1	DOS0	MODE	DESCRIPTION
0	0	Outsel	Decoder output selection is set by output select function [por].
0	1	Tuner	Tuner input is directly connected to decoder output.
1	0	Ext1	Ext1 input is directly connected to decoder output.
1	1	Ext3	Ext3 is directly connected to decoder output.

Note

1. With the decoder output select some special connections can be made overruling the output select (OSL, OSR and OSN), e.g. for connecting a decoder box to the VCR.

6.9 Left/Right (L/R) volume byte**Table 24** Bits of Left/Right volume byte

BIT	DESCRIPTION
VLM	Volume Left Mute; see Table 25
VL5 to VL0	Volume Left 5 to Volume Left 0; see Table 25
VRM	Volume Right Mute; see Table 25
VR5 to VR0	Volume Right 5 to Volume Right 0; see Table 25

Table 25 Left/Right volume byte; notes 1 and 2

VLM	VL5	VL4	VL3	VL2	VL1	VL0	MODE
VRM	VR5	VR4	VR3	VR2	VR1	VR0	
1	X	X	X	X	X	X	mute
0	0	0	0	0	0	0	-49 dB
0	0	0	0	0	0	1	-48 dB
0	0	0	0	0	1	0	-47 dB
0	0	0	0	0	1	1	-46 dB
0	0	0	0	1	0	0	-45 dB
0	0	0	0	1	0	1	-44 dB
0	0	0	0	1	1	0	-43 dB
0	0	0	0	1	1	1	-42 dB
0	0	0	1	0	0	0	-41 dB
0	0	0	1	0	0	1	-40 dB
0	0	0	1	0	1	0	-39 dB
0	0	0	1	0	1	1	-38 dB
0	0	0	1	1	0	0	-37 dB
0	0	0	1	1	0	1	-36 dB
0	0	0	1	1	1	0	-35 dB
0	0	0	1	1	1	1	-34 dB
0	0	1	0	0	0	0	-33 dB
0	0	1	0	0	0	1	-32 dB
0	0	1	0	0	1	0	-31 dB

Audio processor for VHS hi-fi and linear audio

TDA9614H

VLM	VL5	VL4	VL3	VL2	VL1	VL0	MODE
VRM	VR5	VR4	VR3	VR2	VR1	VR0	
0	0	1	0	0	1	1	-30 dB
0	0	1	0	1	0	0	-29 dB
0	0	1	0	1	0	1	-28 dB
0	0	1	0	1	1	0	-27 dB
0	0	1	0	1	1	1	-26 dB
0	0	1	1	0	0	0	-25 dB
0	0	1	1	0	0	1	-24 dB
0	0	1	1	0	1	0	-23 dB
0	0	1	1	0	1	1	-22 dB
0	0	1	1	1	0	0	-21 dB
0	0	1	1	1	0	1	-20 dB
0	0	1	1	1	1	0	-19 dB
0	0	1	1	1	1	1	-18 dB
0	1	0	0	0	0	0	-17 dB
0	1	0	0	0	0	1	-16 dB
0	1	0	0	0	1	0	-15 dB
0	1	0	0	0	1	1	-14 dB
0	1	0	0	1	0	0	-13 dB
0	1	0	0	1	0	1	-12 dB
0	1	0	0	1	1	0	-11 dB
0	1	0	0	1	1	1	-10 dB
0	1	0	1	0	0	0	-9 dB
0	1	0	1	0	0	1	-8 dB
0	1	0	1	0	1	0	-7 dB
0	1	0	1	0	1	1	-6 dB
0	1	0	1	1	0	0	-5 dB
0	1	0	1	1	0	1	-4 dB
0	1	0	1	1	1	0	-3 dB
0	1	0	1	1	1	1	-2 dB
0	1	1	0	0	0	0	-1 dB
0	1	1	0	0	0	1	0 dB [por]
0	1	1	0	0	1	0	1 dB
0	1	1	0	0	1	1	2 dB
0	1	1	0	1	0	0	3 dB
0	1	1	0	1	0	1	4 dB
0	1	1	0	1	1	0	5 dB
0	1	1	0	1	1	1	6 dB
0	1	1	1	0	0	0	7 dB
0	1	1	1	0	0	1	8 dB

Audio processor for VHS hi-fi and linear audio

TDA9614H

VLM	VL5	VL4	VL3	VL2	VL1	VL0	MODE
VRM	VR5	VR4	VR3	VR2	VR1	VR0	
0	1	1	1	0	1	0	9 dB
0	1	1	1	0	1	1	10 dB
0	1	1	1	1	0	0	11 dB
0	1	1	1	1	0	1	12 dB
0	1	1	1	1	1	0	13 dB
0	1	1	1	1	1	1	14 dB

Notes

1. X = don't care.
2. Optimum mute performance is achieved by combination of the mute bit (VLM and/or VRM) with the smallest volume setting (Vx5 to Vx0 = '000000').

6.10 Headphone volume byte**Table 26** Bits of Left/Right volume byte

BIT	DESCRIPTION
VHM	Volume Headphone Mute; see Table 27
VH5 to VH0	Volume Headphone 5 to Volume Headphone 0; see Table 27

Table 27 Headphone volume byte; notes 1 and 2

VHM	VH5	VH4	VH3	VH2	VH1	VH0	MODE
1	X	X	X	X	X	X	mute
0	0	0	0	0	0	0	-47 dB
0	0	0	0	0	0	1	-46 dB
0	0	0	0	0	1	0	-45 dB
0	0	0	0	0	1	1	-44 dB
0	0	0	0	1	0	0	-43 dB
0	0	0	0	1	0	1	-42 dB
0	0	0	0	1	1	0	-41 dB
0	0	0	0	1	1	1	-40 dB
0	0	0	1	0	0	0	-39 dB
0	0	0	1	0	0	1	-38 dB
0	0	0	1	0	1	0	-37 dB
0	0	0	1	0	1	1	-36 dB
0	0	0	1	1	0	0	-35 dB
0	0	0	1	1	0	1	-34 dB
0	0	0	1	1	1	0	-33 dB
0	0	0	1	1	1	1	-32 dB
0	0	1	0	0	0	0	-31 dB
0	0	1	0	0	0	1	-30 dB
0	0	1	0	0	1	0	-29 dB

Audio processor for VHS hi-fi and linear audio

TDA9614H

VHM	VH5	VH4	VH3	VH2	VH1	VH0	MODE
0	0	1	0	0	1	1	-28 dB
0	0	1	0	1	0	0	-27 dB
0	0	1	0	1	0	1	-26 dB
0	0	1	0	1	1	0	-25 dB
0	0	1	0	1	1	1	-24 dB
0	0	1	1	0	0	0	-23 dB
0	0	1	1	0	0	1	-22 dB
0	0	1	1	0	1	0	-21 dB
0	0	1	1	0	1	1	-20 dB
0	0	1	1	1	0	0	-19 dB
0	0	1	1	1	0	1	-18 dB
0	0	1	1	1	1	0	-17 dB
0	0	1	1	1	1	1	-16 dB
0	1	0	0	0	0	0	-15 dB
0	1	0	0	0	0	1	-14 dB
0	1	0	0	0	1	0	-13 dB
0	1	0	0	0	1	1	-12 dB
0	1	0	0	1	0	0	-11 dB
0	1	0	0	1	0	1	-10 dB
0	1	0	0	1	1	0	-9 dB
0	1	0	0	1	1	1	-8 dB
0	1	0	1	0	0	0	-7 dB
0	1	0	1	0	0	1	-6 dB
0	1	0	1	0	1	0	-5 dB
0	1	0	1	0	1	1	-4 dB
0	1	0	1	1	0	0	-3 dB
0	1	0	1	1	0	1	-2 dB
0	1	0	1	1	1	0	-1 dB
0	1	0	1	1	1	1	0 dB [por]
0	1	1	0	0	0	0	1 dB
0	1	1	0	0	0	1	2 dB
0	1	1	0	0	1	0	3 dB
0	1	1	0	0	1	1	4 dB
0	1	1	0	1	0	0	5 dB
0	1	1	0	1	0	1	6 dB
0	1	1	0	1	1	0	7 dB
0	1	1	0	1	1	1	8 dB
0	1	1	1	0	0	0	9 dB
0	1	1	1	0	0	1	10 dB
0	1	1	1	0	1	0	11 dB
0	1	1	1	0	1	1	12 dB

Audio processor for VHS hi-fi and linear audio

TDA9614H

VHM	VH5	VH4	VH3	VH2	VH1	VH0	MODE
0	1	1	1	1	0	0	13 dB
0	1	1	1	1	0	1	14 dB
0	1	1	1	1	1	0	15 dB
0	1	1	1	1	1	1	16 dB

Notes

1. X = don't care.
2. Optimum mute performance is achieved by combination of the mute bit (VHM) with the smallest volume setting (VH5 to VH0 = '000000').

6.11 Install byte**Table 28** Bits of install byte

BIT	DESCRIPTION
DEV1 and DEV0	Deviation 1 and Deviation 0; see Table 29
NPL3 to NPL0	Normal Playback Level 3 to Normal Playback Level 0; see Table 30
AUTN	Auto Normal; see Table 31
DOC	Drop-out Cancellation; see Table 32

Table 29 Bits DEV1 and DEV0; note 1

DEV1	DEV0	MODE	DESCRIPTION
0	0	56 kHz	deviation of modem set to 56 kHz (equals 50 kHz; -10 dBV); 1 kHz audio
0	1	50 kHz	deviation of modem set to 50 kHz (equals 50 kHz; -8 dBV); 1 kHz audio
1	0	45 kHz	deviation of modem set to 45 kHz (equals 50 kHz; -6 dBV); 1 kHz audio
1	1	40 kHz	deviation of modem set to 40 kHz (equals 50 kHz; -4 dBV); 1 kHz audio

Note

1. A selection of four different settings of FM deviation/audio level can be made for the audio FM circuit.

Audio processor for VHS hi-fi and linear audio

TDA9614H

Table 30 Normal Playback Level bits; note 1

NPL3	NPL2	NPL1	NPL0	MODE
0	0	0	0	-7 dB
0	0	0	1	-6 dB
0	0	1	0	-5 dB
0	0	1	1	-4 dB
0	1	0	0	-3 dB
0	1	0	1	-2 dB
0	1	1	0	-1 dB
0	1	1	1	0 dB [por]
1	0	0	0	1 dB
1	0	0	1	2 dB
1	0	1	0	3 dB
1	0	1	1	4 dB
1	1	0	0	5 dB
1	1	0	1	6 dB
1	1	1	0	7 dB
1	1	1	1	8 dB

Note

1. A selection of 16 settings of amplification in the linear audio playback amplifier can be made. This can be used for adjustment purposes or as a fixed setting.

Table 31 Bit AUTN; note 1

AUTN	MODE	DESCRIPTION
0	-	Audio FM signal is muted, when no hi-fi tracks are found in playback [por].
1	auto normal	Output select is switched to normal, when no hi-fi tracks are found in playback.

Note

1. When the audio FM circuit is in playback and there is no FM input signal (playback of a conventional recording) the audio FM circuitry is muted. If this situation occurs and AUTN = 1 the selections stereo, left or right in the output select (OSR, OSL and OSN) are overridden and the selection normal is made. This means that linear audio is the output signal for as long as the internal playback mute is active. The status of this internal mute signal can be read by bit PAFM (see Section 6.13).

Table 32 Bit DOC

DOC	MODE	DESCRIPTION
0	-	-
1	drop-out cancel ⁽¹⁾	audibility of short drop-outs is minimized [por]

Note

1. When DOC = 1 an additional sample-and-hold circuit is activated during drop-outs in the FM input signal, minimizing their audibility.

Audio processor for VHS hi-fi and linear audio

TDA9614H

6.12 Test byte

Table 33 Bits of test byte

BIT	DESCRIPTION
STBY	Standby; see Table 34
CALS	Calibration Start; see Table 35
AGCN	AGC Not; see Table 36
TST4 to TST0	Test 4 to Test 0; see Table 37

Table 34 Bit STBY

STBY	MODE	DESCRIPTION
0	–	normal operation [por]
1	standby ⁽¹⁾	standby mode (low power consumption)

Note

- When STBY = 1 the IC is partly switched off to minimize its power consumption. The I²C-bus and the direct connections between inputs and outputs (selectable with bits: LOS1, LOS0, DOS1 and DOS0) are still operable in standby mode.

Table 35 Bit CALS

CALS	MODE	DESCRIPTION
0	–	[por]
1	auto-calibrate ⁽¹⁾	oscillators and BPFs are automatically calibrated

Note

- When CALS is made logic 1 after being logic 0 the IC performs an automatic frequency calibration of the modem CCOs and the built-in bandpass filters (BPFs). During calibration, the IC should be in record or loop-through mode. The calibration takes <500 ms and uses the HID input (25 Hz in PAL mode or 30 Hz in NTSC mode) as the reference frequency. The bit CALR (see Section 6.13) can be read to check if the calibration has been completed successfully.

Table 36 Bit AGCN; note 1

AGCN	MODE	DESCRIPTION
0	AGC on	linear audio record; AGC active [por]
1	AGC off	linear audio record; AGC inactive

Note

- With bit AGCN the linear audio record AGC can be switched (off and on).

Audio processor for VHS hi-fi and linear audio

TDA9614H

Table 37 Test bits TST4 to TST0; note 1

TST4	TST3	TST2	TST1	TST0	MODE	DESCRIPTION
0	0	0	0	0	–	[por]
0	0	0	0	1	VCO test L	in record mode: only 1.4 or 1.3 MHz at FMOUT
0	0	0	1	0	VCO test R	in record mode: only 1.8 or 1.7 MHz at FMOUT
0	0	0	1	1	BPF test L	in playback mode: only left BPF at FMOUT; HF AGC switched off
0	0	1	0	0	BPF test R	in playback mode: only right BPF at FMOUT; HF AGC switched off
0	0	1	0	1	Test	not for application
0	0	1	1	0	Test	not for application
0	0	1	1	1	Test	not for application
0	1	0	0	0	Test	not for application
0	1	0	0	1	Test	not for application
0	1	0	1	0	Test	not for application
0	1	0	1	1	Test	not for application
0	1	1	0	0	Test	not for application
0	1	1	0	1	Test	not for application
0	1	1	1	0	Test	not for application
0	1	1	1	1	Test	not for application
1	0	0	0	0	Test	not for application
1	0	0	0	1	Test	not for application
1	0	0	1	0	Test	not for application
1	0	0	1	1	Test	not for application
1	0	1	0	0	Test	not for application
1	0	1	0	1	Test	not for application
1	0	1	1	0	Test	not for application
1	0	1	1	1	Test	not for application
1	1	0	0	0	Test	not for application
1	1	0	0	1	Test	not for application
1	1	0	1	0	Test	not for application
1	1	0	1	1	Test	not for application
1	1	1	0	0	Test	not for application
1	1	1	0	1	Test	not for application
1	1	1	1	0	Test	not for application
1	1	1	1	1	EQ set ⁽²⁾	linear audio playback equalization using non-standard settings

Notes

1. The bits TST4 to TST0 are used for testing and measurement purposes.
2. Test number 31 (TST4 to TST0 = 11111) is a special setting which can be used to change the internal linear audio playback equalization to non-standard settings as shown in Table 38.

Audio processor for VHS hi-fi and linear audio

TDA9614H

Table 38 Linear audio playback equalization non-standard settings

SETTING	MODE	TEST NUMBER 31
Standard play (LP = 0)	3180 and 120 μ s	not selected
	2544 and 96 μ s	selected
Long play (LP = 1)	3180 and 170 μ s	not selected
	2731 and 146 μ s	selected

6.13 Read byte**Table 39** Bits of read byte

BIT	DESCRIPTION
CALR	Calibration ready; see Table 40
PAFM	Playback Audio FM Mute; see Table 41
POR	Power-On reset; see Table 42

Table 40 Bit CALR; note 1

CALR	MODE	DESCRIPTION
0	not calibrated	IC has not been auto-calibrated [por].
1	calibrated	IC has been calibrated successfully.

Note

1. If CALR = 0, bandpass filters and oscillators have not been calibrated successfully. When an automatic calibration is started by bit CALS, the end of the calibration cycle can be checked via this bit. If for some reason a successful calibration can not be made within the available adjustment range, e.g. if no HID signal is available, CALR will remain logic 0. After calibration the adjustment will be held for as long as the digital supply voltage (V_{DD}) is available.

Table 41 Bit PAFM; note 1

PAFM	MODE	DESCRIPTION
0	AFM available	Audio FM signal is detected at FM input.
1	no AFM carrier	No audio FM signal detected; hi-fi processing is muted.

Note

1. When the hi-fi processing is in playback mode but no Audio FM input signal is found, the IC generates an internal mute signal which mutes the noise signal coming from the demodulators. The status of this mute signal can be read via bit PAFM. This signal however is only valid with the hi-fi circuit in playback (RAF = 0 and IPAF = 0).

Table 42 Bit POR; note 1

POR	MODE	DESCRIPTION
0	–	–
1	POR generated	POR pulse is generated since last read.

Note

1. When the IC is switched on, or a power dip occurs on the digital supply (V_{DD}) line, a Power-on Reset signal is generated which resets the IC's I²C-bus registers and the auto-calibration circuit. If such a situation has occurred after the last time the read byte has been read, bit POR = 1. After reading the read byte POR is reset to logic 0.

Audio processor for VHS hi-fi and linear audio

TDA9614H

7 LIMITING VALUES

In accordance with the Absolute Maximum Rating System (IEC 134).

SYMBOL	PARAMETER	CONDITIONS	MIN.	MAX.	UNIT
V _{DDA1}	analog supply voltage 1		0	13.2	V
V _{DDA2}	analog supply voltage 2		0	5.5	V
V _{DDD}	digital supply voltage		0	5.5	V
V _n	voltage on pins: 1, 2, 3, 4, 5, 6, 7, 8, 9, 10, 11, 28, 41, 44, 51, 52, 63 and 64 56, 60 and 62 12 and 32		0	7.7	V
T _{stg}	storage temperature		-65	+150	°C
T _{amb}	operating ambient temperature		0	+70	°C
V _{es}	electrostatic handling	MM; note 1	-150	+150	V
		HBM; note 2	-1500	+1500	V

Notes

1. Machine Model (MM).
2. Human Body Model (HBM).

8 THERMAL CHARACTERISTICS

SYMBOL	PARAMETER	VALUE	UNIT
R _{th j-a}	thermal resistance from junction to ambient in free air	55	K/W

9 DC CHARACTERISTICS

V_{DDA1} = 12 V; V_{DDA2} = 5 V; V_{DDD} = 5 V; NTSC = 0; LP = 0; CALR = 1; T_{amb} = 25 °C;

all volume control levels set to 0 dB; measured in test circuit (see Fig.13); unless otherwise specified.

SYMBOL	PARAMETER	CONDITIONS	MIN	TYP.	MAX.	UNIT
Supply voltages						
V _{DDA1}	analog supply voltage 1; pin 50		10.5	12	13.2	V
V _{DDA2}	analog supply voltage 2; pin 58		4.75	5	5.5	V
V _{DDD}	digital supply voltage; pin 13		4.75	5	5.5	V
Supply currents						
I _{DDA1}	analog supply current 1; pin 50	operating	–	47	60	mA
		standby	–	28	35	mA
I _{DDA2}	analog supply current 2; pin 58	record ⁽¹⁾ ; LT ⁽²⁾	–	7	9	mA
		playback ⁽³⁾	–	18	23	mA
		standby; LT ⁽²⁾	–	3	5	mA
I _{DDD}	digital supply current; pin 13	operating	–	1	3	mA
		standby	–	1	3	mA

Audio processor for VHS hi-fi and linear audio

TDA9614H

SYMBOL	PARAMETER	CONDITIONS	MIN	TYP.	MAX.	UNIT
Input voltages						
V_I	DC input voltage; pins 1, 2, 3, 4, 5, 6, 7, 8, 9, 10, 11, 28, 31, 34, 35 and 36		–	3.8	–	V
V_{57}	DC input voltage internally generated; pin 57		–	1.9	–	V
V_{30}	DC input voltage internally generated; pin 30		–	0	–	V
$V_{51,64}$	DC input voltage internally generated; pins 51 and 64	playback ⁽³⁾	–	3.8	–	V
$V_{52,63}$	DC input voltage internally generated; pins 52 and 63	record ⁽¹⁾ ; LT ⁽²⁾	–	3.8	–	V
Output voltages						
V_O	DC output voltage:					
	pins 19, 20, 21, 22 and 33		–	6	–	V
	pins 25 and 26		–	5.5	–	V
	pins 18, 29, 42, 53 and 59		–	3.8	–	V
	pin 56	record ⁽¹⁾	–	1.2	–	V
	pin 56	playback ⁽³⁾ ; LT ⁽²⁾	–	1.2	–	V
	pin 55		–	0.6	–	V
	pins 51 and 64	record ⁽¹⁾ ; LT ⁽²⁾	–	4.3	–	V
	pins 52 and 63	playback ⁽³⁾	–	3.3	–	V
Head identification pulse input (HID; pin 61)						
V_{IH}	HIGH level input voltage		2.75	–	5.50	V
V_{IL}	LOW level input voltage		0	–	2.25	V
Normal record pin (LINREC; pin 32)						
V_{OH}	HIGH level output voltage	$I_L = -500 \mu A$	$V_{DDD} - 0.5$	–	–	V
V_{OL}	LOW level output voltage	$I_L = 500 \mu A$	–	–	0.5	V
I/O RAF (pin 12)						
USED AS OUTPUT						
V_{OH}	HIGH level output voltage	RAF = 1; $I_L = -35 \mu A$	$V_{DDD} - 0.25$	–	V_{DDD}	V
V_{OL}	LOW level output voltage	RAF = 0; $I_L = 185 \mu A$	0	–	0.4	V
I_{OH}	HIGH level output current (drive capability)	RAF = 1	–35	–	–	μA
I_{OL}	LOW level output current (drive capability)	RAF = 0	185	–	–	μA

Audio processor for VHS hi-fi and linear audio

TDA9614H

SYMBOL	PARAMETER	CONDITIONS	MIN	TYP.	MAX.	UNIT
USED AS INPUT (OUTPUT OVERRULED)						
V_{IH}	HIGH level input voltage		3.5	–	V_{DDD}	V
V_{IL}	LOW level input voltage		0	–	1.5	V
I_{IH}	HIGH level input current	at V_{IH}	–	–	345	μA
I_{IL}	LOW level input current	at V_{IL}	–	–	–65	μA

Notes

1. Record: record audio FM and record linear audio.
2. Loop-through: loop-through audio FM and loop-through R linear audio.
3. Playback: playback audio FM and playback linear audio.

10 AC CHARACTERISTICS**10.1 Record audio FM mode**

Audio input signal –8 dBV from TUNL and TUNR (pins 2 and 3); $V_{DDA1} = 12\text{ V}$; $V_{DDA2} = 5\text{ V}$; $V_{DDD} = 5\text{ V}$; NTSC = 0; LP = 0; CALR = 1; $f = 1\text{ kHz}$ (audio test frequency); $T_{amb} = 25\text{ }^\circ\text{C}$; all volume control levels set to 0 dB; measured in test circuit (see Fig.13); unless otherwise specified.

SYMBOL	PARAMETER	CONDITIONS	MIN	TYP.	MAX.	UNIT
Audio inputs (SAP, TUNL, TUNR, CINL, CINR, EXT1L, EXT1R, EXT2L, EXT2R, EXT3L and EXT3R; pins 1, 2, 3, 4, 5, 6, 7, 8, 9, 10 and 11)						
R_i	input resistance		100	130	–	$\text{k}\Omega$
V_{iAF}	audio input voltage		–	–	8	dBV
Line and decoder outputs (LINE1L, LINE1R, LINE2L and LINE2R; pins 21, 22, 19 and 20)						
$V_{o(max)}$	maximum output voltage		–9	–8	–7	dBV
		THD = 1%; $R_L = 5\text{ k}\Omega$; $C_L = 2.2\text{ nF}$; TUNL $\leq -3\text{ dBV}$; TUNR $\leq -3\text{ dBV}$; note 1	10	11	–	dBV
R_o	output resistance		–	200	275	Ω
THD	total harmonic distortion		–	0.01	0.1	%
V_n	noise level	$f_i = 300\text{ Hz to }20\text{ kHz}$; TUNL and TUNR AC grounded	–	–91	–87	dBV
α_{cb}	channel balance		–1	0	+1	dB
V_{mute}	volume mute level		–	–100	–80	dBV
α_{ct}	crosstalk between channels	one channel driven	–	–83	–78	dBV
f_{res}	frequency response with respect to 1 kHz; low-pass filter transfer	$f_i = 20\text{ kHz}$	–0.5	–0.1	+0.5	dB
		$f_i = 60\text{ kHz}$	–	–12	–5	dB
$\alpha_{ct(max)}$	maximum audio input crosstalk	–8 dBV at a not selected stereo audio input	–	–90	–	dBV

Audio processor for VHS hi-fi and linear audio

TDA9614H

SYMBOL	PARAMETER	CONDITIONS	MIN	TYP.	MAX.	UNIT
VU meter drive (DCOUTL and DCOUTR; pins 23 and 24); square root of output voltage (see Fig.7)						
V_o	output voltage		1.69	1.8	1.91	V
R_o	output resistance		–	100	–	Ω
V_o	output voltage at maximum record level	TUNL = –3 dBV; TUNR = –3 dBV; note 1	$V_{DDDD} - 0.5$	–	V_{DDDD}	V
V_{oz}	output voltage for zero-level input		–	–	300	mV
α_{cb}	channel balance		–0.11	–	+0.11	dB
RF converter drive output; mono RFCOUT; pin 18 (see Fig.8)						
V_o	output voltage		–9	–8	–7	dBV
R_o	output resistance		–	100	–	Ω
THD	total harmonic distortion		–	0.01	–	%
V_o	output voltage at maximum record level	TUNL = –3 dBV; TUNR = –3 dBV; note 1	–5	–3	–1	dBV
THD	total harmonic distortion at maximum record level	TUNL = –3 dBV; TUNR = –3 dBV; note 1	–	0.3	–	%
Headphone outputs (HPOUTL and HPOUTR; pins 25 and 26); headphone volume set to 0 dB						
V_o	output voltage		–9	–8	–7	dBV
R_o	output resistance		–	1	–	Ω
THD	total harmonic distortion		–	0.01	0.1	%
$V_{o(max)}$	maximum output voltage	THD = 1%; TUNL \leq –3 dBV; TUNR \leq –3 dBV; $R_L = 250 \Omega$; note 1	9.0	9.5	–	dBV
V_n	noise level	$f_i = 300 \text{ Hz to } 20 \text{ kHz}$; tuner AC grounded	–	–90	–80	dBV
α_{ct}	crosstalk between channels	one channel driven	–	–83	–70	dBV
V_{mute}	headphone volume mute level		–	–90	–70	dBV
α_{cb}	channel balance		–1	–	+1	dB

Audio processor for VHS hi-fi and linear audio

TDA9614H

SYMBOL	PARAMETER	CONDITIONS	MIN	TYP.	MAX.	UNIT
Audio outputs (AFNL and AFNR; pins 64 and 51); audio output from noise reduction						
V_{oAF}	audio output voltage		-12.5	-11.5	-10.5	dBV
THD	total harmonic distortion		-	0.12	0.3	%
V_{oAF}	audio output voltage at maximum record level	TUNL = -3 dBV; TUNR = -3 dBV; note 1	-3.5	-2	-0.5	dBV
THD	total harmonic distortion at maximum record level	TUNL = -3 dBV; TUNR = -3 dBV; note 1	-	0.2	3	%
V_n	noise level	f_i = 300 Hz to 20 kHz; tuner AC grounded	-	-54	-52	dBV
α_{cb}	channel balance		-1	-	+1	dB
L	linearity	V_i = -8 to -68 dBV	28.5	30	31.5	dB
α_{cc}	channel crosstalk	one channel driven	-	-58	-50	dBV
t_{att}	attack time according VHS		-	5	-	ms
t_{rec}	recovery time according VHS		-	70	-	ms
V_{mute}	mute level	MUTE = 1	-	-52	-	dBV
	frequency response with respect to 1 kHz; output level	f_i = 300 Hz	-0.9	-0.2	+0.5	dB
		f_i = 10 kHz	2.9	3.9	4.9	dB
FM modulator (audio input from AFML and AFMR; pins 63 and 52)						
THD	total harmonic distortion	Δf = 50 kHz	-	0.1	0.2	%
Δf	FM frequency deviation	V_{iAF} = -11.5 dBV; NTSC = 0	45	50	55	kHz
		V_{iAF} = -11.5 dBV; NTSC = 1	45	50	55	kHz
		audio input signal from NR outputs AFNL and AFNR; NTSC = 0	44.5	50	56.1	kHz
		audio input signal from NR outputs AFNL and AFNR; NTSC = 1	44.5	50	56.1	kHz
Δf_{max}	maximum FM frequency deviation		140	150	160	kHz
f_{oL}	FM centre frequency left	f = 1.4 MHz; NTSC = 0; calibrated in PAL mode	1395	1400	1405	kHz
		f = 1.3 MHz; NTSC = 1; calibrated in NTSC mode	1295	1300	1305	kHz
		NTSC = 1; calibrated in PAL mode	-	1300	-	kHz

Audio processor for VHS hi-fi and linear audio

TDA9614H

SYMBOL	PARAMETER	CONDITIONS	MIN	TYP.	MAX.	UNIT
f _{oR}	FM centre frequency right	f = 1.8 MHz; NTSC = 0; calibrated in PAL mode	1795	1800	1805	kHz
		f = 1.7 MHz; NTSC = 1; calibrated in NTSC mode	1695	1700	1705	kHz
		NTSC = 1; calibrated in PAL mode	–	1700	–	kHz
TC	temperature coefficient		–	±50	–	10 ⁻⁶ /K
HF output stage (FMOU; pin 56)						
V _{oR(p-p)}	right output voltage (peak-to-peak value)	f _{oR} = 1.8 MHz; 1st harmonic	455	510	572	mV
		f _{oR} = 1.7 MHz; 1st harmonic	455	510	572	mV
V _{oL(p-p)}	left output voltage (peak-to-peak value)	f _{oL} = 1.4 MHz; 1st harmonic	152	170	190	mV
		f _{oL} = 1.3 MHz; 1st harmonic	152	170	190	mV
$\frac{V_{oR}}{V_{oL}}$	ratio of output voltages		2.7	3	3.3	
α _{3rd}	3rd harmonic suppression	NTSC = 0	20	30	–	dB
		NTSC = 1	18	28	–	dB
R _o	output resistance		–	100	130	Ω

Note

- Record volume control for left and right channel set to maximum (+14 dB). Headphone volume control at 0 dB.

10.2 Record linear audio mode

Audio input signal –8 dBV from SAP, TUNL and TUNR (pins 1, 2 and 3); NormSel is input; OutSel is normal.

SYMBOL	PARAMETER	CONDITIONS	MIN.	TYP.	MAX.	UNIT
Linear audio playback input; PBIN (pin 34)						
Z _i	input impedance	I _L = ±1 mA	–	7	15	Ω
Linear audio EQSW input (pin 30)						
Z _i	input impedance	LP = 0	100	150	–	kΩ
		LP = 1	–	15	30	Ω
Line output (pins 21 and 22)						
V _o	output voltage	AGCN = 0; note 1	–8	–6	–4	dBV
		AGCN = 1; NormSel = volume; note 1	–10	–8	–6	dBv
α _{ct}	crosstalk (linear to stereo)	OutSel = stereo; NormSel = SAP; TUNL and TUNR AC grounded	–	–88	–80	dBV

Audio processor for VHS hi-fi and linear audio

TDA9614H

SYMBOL	PARAMETER	CONDITIONS	MIN.	TYP.	MAX.	UNIT
Linear audio record output RECOUT; pin 33 (see Fig.11)						
V _o	output voltage	AGCN = 0; note 1	-2	0	+2	dBV
		AGCN = 1; NormSel = volume; note 1	-4	-2	0	dBv
THD	total harmonic distortion	AGCN = 1; NormSel = volume	-	0.02	0.5	%
V _n	noise level	AGCN = 1; TUNL and TUNR AC grounded	-	-80	-70	dBV
Z _o	output impedance		-	100	200	Ω
V _{mute}	mute level	loop-through R; NOM = mute	-	-85	-	dBV
Linear audio RECEQ (pin 31)						
Z _t	transfer impedance	note 2	900	1200	1500	Ω

Notes

- Using AGC on (AGCN = 0) and NormSel set to volume mode. The AGC gain is 1 dB higher for audio signals below the AGC clip level (specified value of AGC clip level does not change).

Using AGC off (AGCN = 1) and NormSel not set to volume mode, the output signal is 1 dB lower (1 dB below the specified value).

- The transfer A of the REC equalizer from LININ to RECOUT is: $A = \frac{(R + Z)}{Z} \times 3.98$

where Z is the (complex) impedance at pin RECEQ to ground and R is the specified resistance of 1200 Ω.

10.3 Playback Audio FM mode

Audio output signal from the FM (de)modulator at AFML and AFMR (pins 63 and 52).

SYMBOL	PARAMETER	CONDITIONS	MIN	TYP.	MAX.	UNIT
Bandpass filters (filter curves measured using test numbers 3 and 4 [HF AGC off])						
V _{o(rms)}	output voltage level at FMOUT (RMS value)	V _{iHF(rms)} = 30 mV; 1.3 MHz BPF	105	150	215	mV
		V _{iHF(rms)} = 30 mV; 1.4 MHz BPF	105	150	215	mV
		V _{iHF(rms)} = 30 mV; 1.7 MHz BPF	105	150	215	mV
		V _{iHF(rms)} = 30 mV; 1.8 MHz BPF	105	150	215	mV
	1.4 MHz BPF	1.0 MHz/1.4 MHz	-	-30	-20	dB
		1.25 MHz/1.4 MHz	-6	-3	-	dB
		1.55 MHz/1.4 MHz	-7	-3	-	dB
		1.65 MHz/1.4 MHz	-	-17	-12	dB
		1.55 MHz/1.65 MHz	10	15	-	dB
		1.8 MHz/1.4 MHz	-	-	-30	dB

Audio processor for VHS hi-fi and linear audio

TDA9614H

SYMBOL	PARAMETER	CONDITIONS	MIN	TYP.	MAX.	UNIT
	1.8 MHz BPF	1.4 MHz/1.8 MHz	–	–	–30	dB
		1.55 MHz/1.8 MHz	–	–17	–10	dB
		1.65 MHz/1.8 MHz	–7	–3	–	dB
		1.95 MHz/1.8 MHz	–3	0	–	dB
		2.2 MHz/1.8 MHz		–25	–15	dB
	1.3 MHz BPF	1.45 MHz/1.3 MHz	–7	–3	–	dB
		1.55 MHz/1.3 MHz	–	–17	–12	dB
		1.45 MHz/1.55 MHz	10	15	–	dB
	1.7 MHz BPF	1.45 MHz/1.7 MHz	–	–17	–10	dB
		1.55 MHz/1.7 MHz	–7	–3	–	dB
		1.55 MHz/1.45 MHz	10	15	–	dB
f_{shift}	frequency shift of BPF curve with temperature	$T_{\text{amb}} = 0 \text{ to } 70 \text{ }^{\circ}\text{C}$	–	10	–	kHz
HF AGC						
$V_{i \text{ max(p-p)}}$	maximum input signal level (peak-to-peak value)	1.4 and 1.8 MHz carrier added	–	–	1.25	V
$V_{oL(\text{rms})}$	left BPF output voltage level (RMS value)	$f_i = 1.4 \text{ MHz at FMIN};$ $V_{iHF(\text{rms})} = 4 \text{ mV}$	13	19	28	mV
		$f_i = 1.4 \text{ MHz at FMIN};$ $V_{iHF(\text{rms})} = 25 \text{ mV}$	84	120	170	mV
		$f_i = 1.4 \text{ MHz at FMIN};$ $V_{iHF(\text{rms})} = 125 \text{ mV}$	84	120	170	mV
$V_{oR(\text{rms})}$	right BPF output voltage level (RMS value)	$f_i = 1.8 \text{ MHz at FMIN};$ $V_{iHF(\text{rms})} = 4 \text{ mV}$	13	19	28	mV
		$f_i = 1.8 \text{ MHz at FMIN};$ $V_{iHF(\text{rms})} = 25 \text{ mV}$	84	120	170	mV
		$f_i = 1.8 \text{ MHz at FMIN};$ $V_{iHF(\text{rms})} = 125 \text{ mV}$	84	120	170	mV
B	–3 dB bandwidth	$V_{iHF(\text{rms})} = 75 \text{ mV};$ 1.4 MHz carrier	–	10	–	kHz
PLL FM demodulator and limiter						
α_{AM}	AM rejection	$V_{iHF(\text{rms})} = 2 \text{ to } 200 \text{ mV};$ $m = 30\%$	–	–70	–	dBV
$V_{i(\text{rms})}$	sensitivity; PLL locked (RMS value)	$\Delta f = 150 \text{ kHz};$ $S/N = 35 \text{ dB (audio)}$	–	0.6	1.25	mV
THD	total harmonic distortion	$\Delta f = 50 \text{ kHz}$	–	0.03	0.3	%
		$\Delta f = 150 \text{ kHz}$	–	0.2	1.5	%
S/N	signal-to-noise ratio	$V_{iHF} = 30 \text{ mV}; \Delta f = 50 \text{ kHz}$	54	57	–	dB
V_{oAF}	AF output voltage	$\Delta f = 50 \text{ kHz}$	–12.5	–11.5	–10.5	dBV
V_{step}	step response	note 1	–	–	–48	dBV
α_{ct}	crosstalk between channels	L to R; R to L	–	–90	–	dBV

Audio processor for VHS hi-fi and linear audio

TDA9614H

SYMBOL	PARAMETER	CONDITIONS	MIN	TYP.	MAX.	UNIT
Sample-and-hold (see Fig.9)						
t_h	hold time pulse width		5	6	7	μs
d_{AF}	audio distortion	note 2	–	–	–75	dB
t_d	delay from HID pulse to hold pulse		–	0.4	–	μs
Drop-Out Cancellation (DOC)						
	DOC activation level w.r.t. mute activation level		–7	–4	–2	dB
$t_{d(\text{off})}$	switch-off delay time	no signal to signal	5	9	14	μs
Mute timing (CMUTE; pin 62)						
$V_{i(\text{rms})}$	mute activation level (RMS value) referenced to FMIN		2.2	4.2	7.1	mV
$t_{d(\text{off})}$	switch-off delay time	signal to no signal	–	15	–	ms
$t_{d(\text{on})}$	switch-on delay time	no signal to signal	–	400	–	ms
Level detector output ENVOUT; pin 60 (see Fig.10)						
V_o	output voltage level	f_i (FMIN) = 1.4 MHz; $V_{iHF(\text{rms})} = 2$ mV	0.6	0.9	1.2	V
		f_i (FMIN) = 1.4 MHz; $V_{iHF(\text{rms})} = 20$ mV	2.5	2.9	3.3	V
		f_i (FMIN) = 1.4 MHz; $V_{iHF(\text{rms})} = 200$ mV	4.1	4.5	4.8	V
R_o	output resistance		–	33	–	$\text{k}\Omega$
Line outputs (LINEL and LINER; pins 27 and 28); audio inputs at AFNL and AFNR (pins 64 and 51): –11.5 dBV						
V_o	output voltage		–10	–8	–6	dBV
		input signal from modem to AFML and AFMR	–10	–8	–6	dBV
V_n	noise level	$f_i = 300$ Hz to 20 kHz	–	–98	–90	dBV
THD	total harmonic distortion		–	0.05	0.2	%
L	linearity	$V_{iAF} = -11.5$ to -41.5 dBV	58	60	62	dB
α_{cb}	channel balance		–2	0	+2	dB
f_{res}	frequency response with respect to 1 kHz; output level	$f_i = 300$ Hz	–1	+0.4	+1.8	dB
		$f_i = 10$ kHz	–9.7	–7.7	–5.7	dB

Notes

- HID pulse frequency set to 1 kHz. Unmodulated carrier at FMIN input with 135° phase step.
- The audio distortion is measured with the HID pulse frequency set to 1 kHz ($f_i = 500$ Hz). FM signal: $f_m = 10$ kHz; $\Delta f = 50$ kHz. The distortion is measured with a 3 kHz 4th-order low-pass filter. The measured value at 1 kHz HID-pulse frequency is corrected with 26 dB in order to calculate the equivalent distortion at 50 Hz HID-pulse frequency.

Audio processor for VHS hi-fi and linear audio

TDA9614H

10.4 Playback linear audio

Audio input signal -68 dBV from PBIN (pin 34).

SYMBOL	PARAMETER	CONDITIONS	MIN	TYP.	MAX.	UNIT
Linear audio playback input PBIN (pin 34)						
Z_i	input impedance		60	100	-	k Ω
V_o	output voltage at LINOUT		-14	-12	-10	dBV
Linear audio RESSW input (pin 35)						
Z	impedance between RESSW and PBIN	LP = 0	-	50	100	Ω
		LP = 1	100	150	-	k Ω
Line outputs LINEL and LINER (pins 21 and 22)						
V_o	output voltage	LP = 0	-8	-6	-4	dBV
		LP = 1	-6.7	-4.7	-2.7	dBV
f_{res}	frequency response with respect to 1 kHz; output level	$f_i = 315$ Hz; LP = 0	7.2	8.2	9.2	dB
		$f_i = 10$ kHz; LP = 0	-5.4	-4.4	-3.4	dB
		$f_i = 315$ Hz; LP = 1	5.9	6.9	7.9	dB
		$f_i = 10$ kHz; LP = 1	-3.7	-2.7	-1.7	dB
THD	total harmonic distortion		-	0.05	0.5	%
$V_{o(max)}$	maximum output voltage	THD = 1%	-	10	-	dBV
V_n	noise level	$f_i = 300$ Hz to 20 kHz	-	-58	-55	dBV
		referenced to PBIN	-	-120	-	dBV

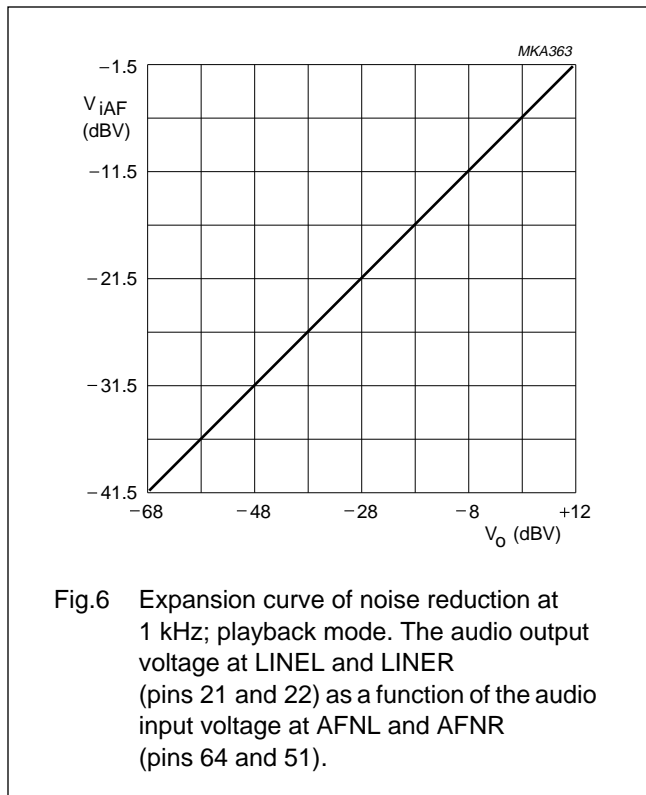
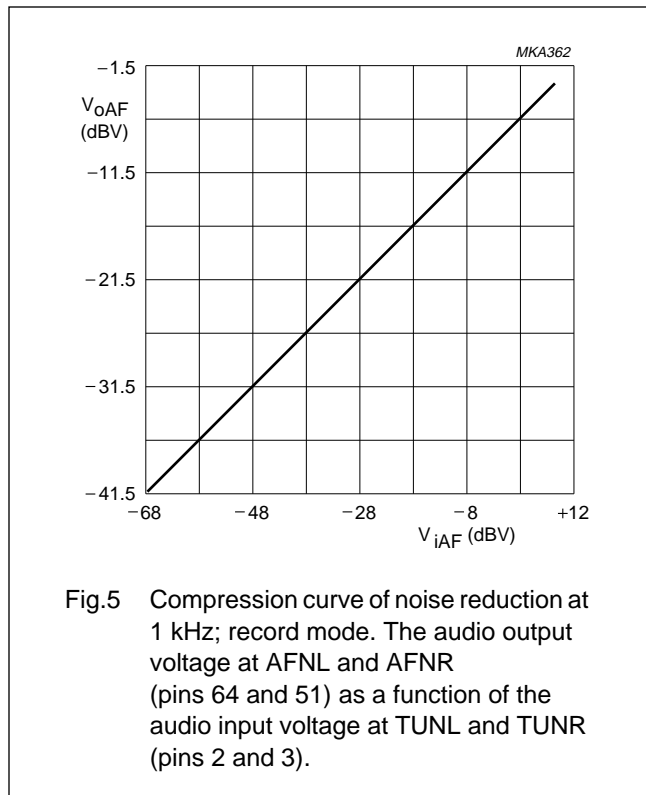

Audio processor for VHS hi-fi
and linear audio

TDA9614H

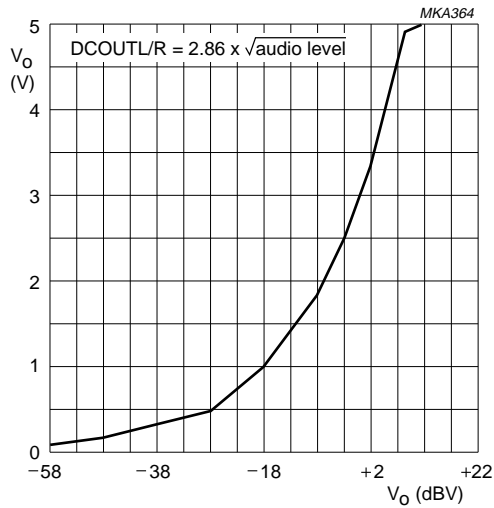

Fig.7 VU meter output voltage at DCOUTL and DCOUTR (pins 23 and 24) as a function of audio signal level.

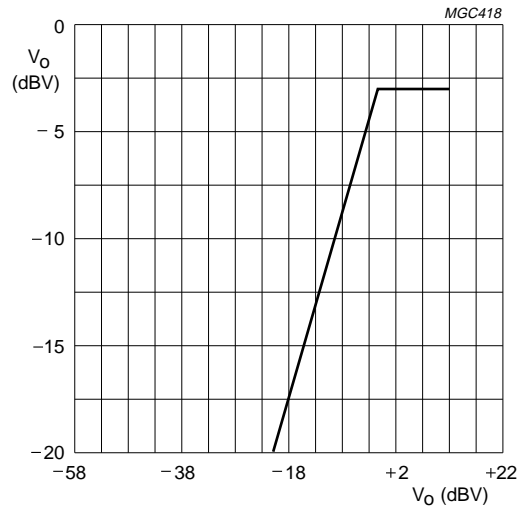

Fig.8 RF converter output voltage at RFCOUT (pin 18) as a function of line output signal level at LINEL and LINER (pins 21 and 22).

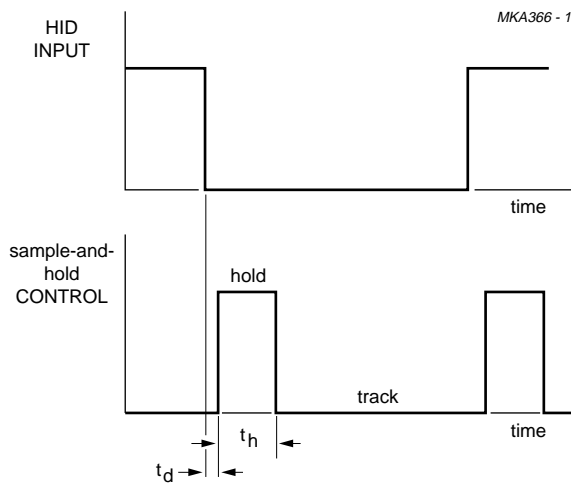

Fig.9 Sample-and-hold timing waveforms.

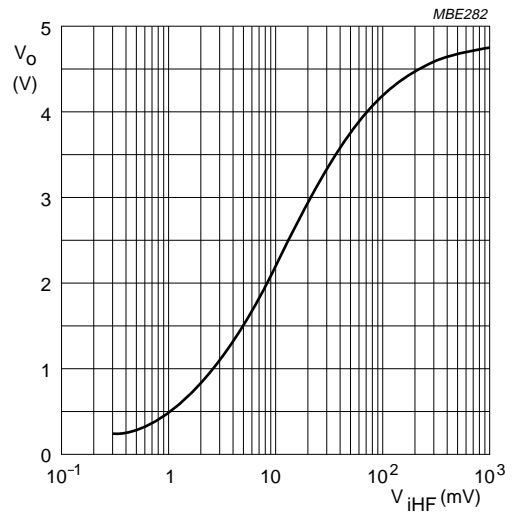
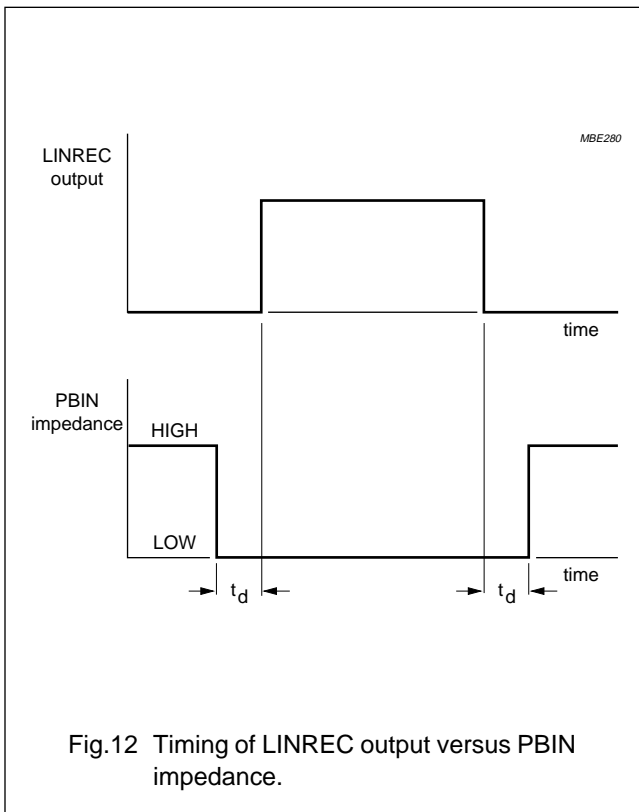
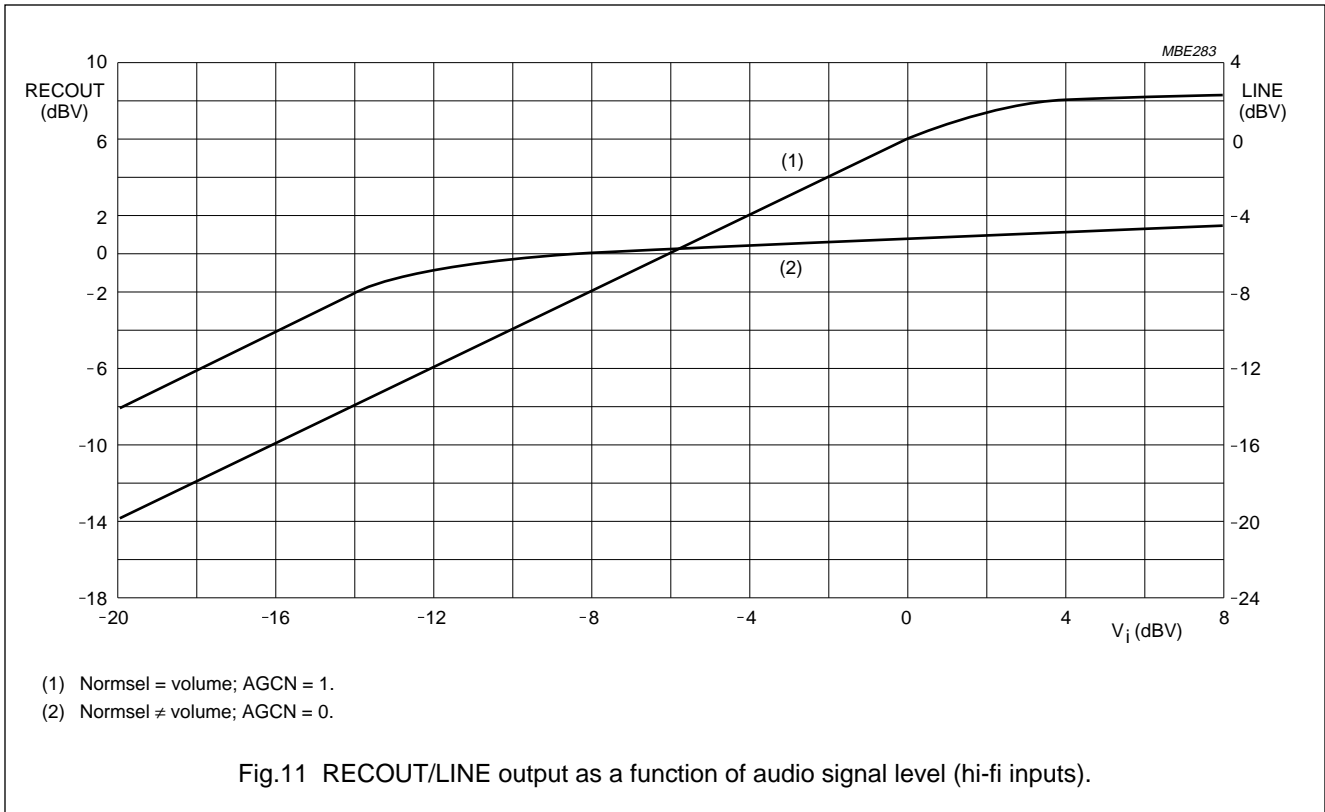

Fig.10 Level detector output voltage at ENVOUT (pin 60) as a function of the 1.4 MHz carrier input voltage level (RMS value) at FMIN (pin 57).

Audio processor for VHS hi-fi
and linear audio

TDA9614H



Audio processor for VHS hi-fi
and linear audio

TDA9614H

11 INTERNAL CIRCUITRY

SYMBOL	PIN	EQUIVALENT CIRCUIT	DESCRIPTION
SAP	1		Second Audio Program (SAP) input.
TUNL	2		Left channel tuner input.
TUNR	3		Right channel tuner input.
CINL	4		Left channel cinch input.
CINR	5		Right channel cinch input.
EXT1L	6		Left channel external 1 input.
EXT1R	7		Right channel external 1 input.

Audio processor for VHS hi-fi
and linear audio

TDA9614H

SYMBOL	PIN	EQUIVALENT CIRCUIT	DESCRIPTION
EXT2L	8	<p>MLD015</p>	Left channel external 2 input.
EXT2R	9	<p>MLD016</p>	Right channel external 2 input.
EXT3L	10	<p>MLD017</p>	Left channel external 3 input.
EXT3R	11	<p>MLD018</p>	Right channel external 3 input.
RAF	12	<p>MLD019</p>	Record/playback switch drive output for head amplifier control or input for overruling the I ² C-bit RAF.
V _{DDD}	13		Digital supply voltage for I ² C-bus (+5 V).

Audio processor for VHS hi-fi
and linear audio

TDA9614H

SYMBOL	PIN	EQUIVALENT CIRCUIT	DESCRIPTION
SDA	14		Data input/output for I ² C-bus.
SCL	15		Clock input for I ² C-bus.
V _{SSD}	16		Digital ground for I ² C-bus.
RFCAGC	17		RF converter AGC-time constant.
RFCOUT	18		RF converter drive output.

Audio processor for VHS hi-fi
and linear audio

TDA9614H

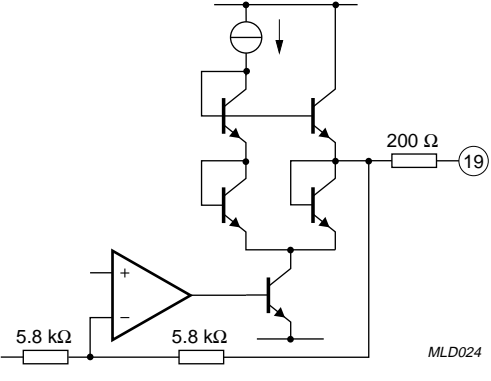
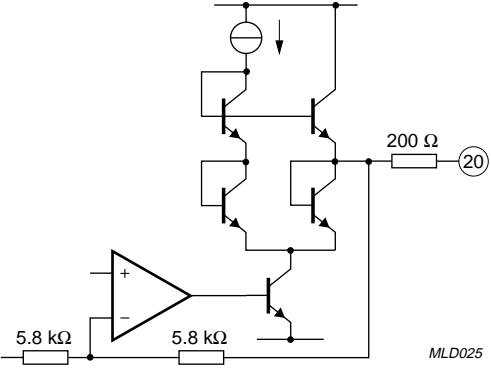
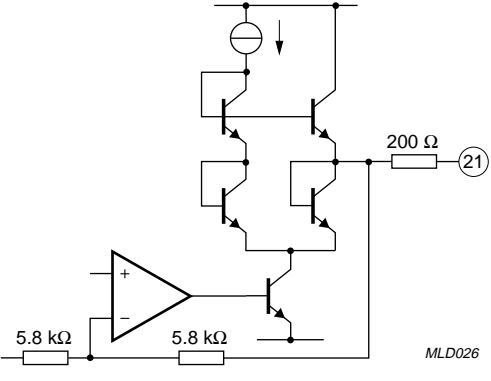
SYMBOL	PIN	EQUIVALENT CIRCUIT	DESCRIPTION
LINE2L	19		Line 2 left output (e.g. decoder output).
LINE2R	20		Line 2 right output (e.g. decoder output).
LINEL	21		Line output left.

Audio processor for VHS hi-fi
and linear audio

TDA9614H

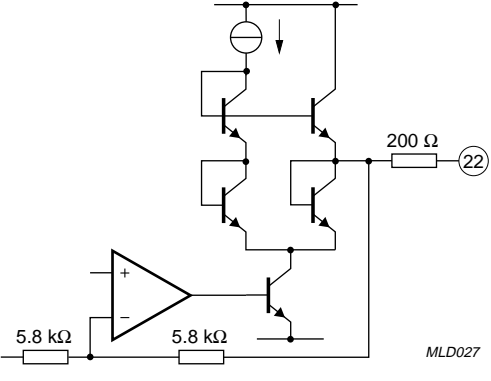
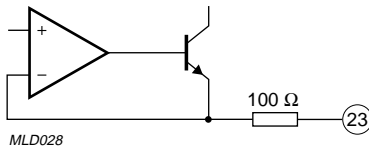
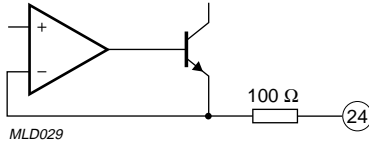
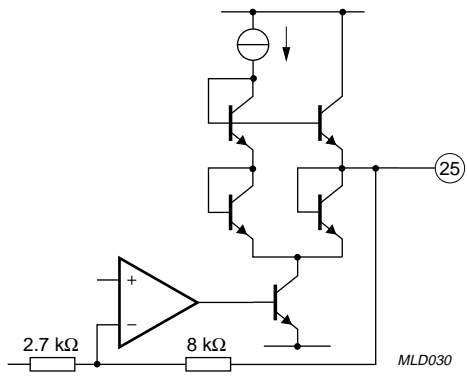
SYMBOL	PIN	EQUIVALENT CIRCUIT	DESCRIPTION
LINER	22		Line output right.
DCOUTL	23		VU meter drive output left.
DCOUTR	24		VU meter drive output right.
HPOUTL	25		Headphone drive output left.

Audio processor for VHS hi-fi
and linear audio

TDA9614H

SYMBOL	PIN	EQUIVALENT CIRCUIT	DESCRIPTION
HPOUTR	26		Headphone drive output right.
LINAGC	27		Linear audio AGC-time constant.
LININ	28		Audio input for linear audio to REC equalizer and output select.
LINOUT	29		Audio output from AGC or PB equalizer.
EQSW	30		Long Play (LP) equalization switch; 15 Ω on resistance and 150 kΩ input impedance.

Audio processor for VHS hi-fi
and linear audio

TDA9614H

SYMBOL	PIN	EQUIVALENT CIRCUIT	DESCRIPTION
RECEQ	31		<p>Linear audio recording amplifier negative feedback input for connecting a record equalization network.</p>
LINREC	32		<p>Digital output controlled by I²C-bit RN; can be used to drive an external (high voltage) head switch and possibly the bias oscillator.</p>
RECOU	33		<p>Linear audio recording amplifier output.</p>

Audio processor for VHS hi-fi
and linear audio

TDA9614H

SYMBOL	PIN	EQUIVALENT CIRCUIT	DESCRIPTION
PBIN	34	<p style="text-align: right;"><i>MLD039</i></p>	<p>Linear audio playback amplifier input; during playback the impedance is 100 kΩ; during record the impedance is 7 Ω.</p>
RESSW	35		<p>Long Play equalization switch 50 Ω on and 150 kΩ off impedance to PBIN.</p>
PBDC	36		<p>Linear audio playback amplifier DC decoupling.</p>
DCFBL	37	<p style="text-align: right;"><i>MLD040</i></p>	<p>DC feedback left.</p>
DCREFL	38		<p>DC reference left.</p>
EMPHL	39		<p>Total emphasis left (240 to 20 μs).</p>

Audio processor for VHS hi-fi
and linear audio

TDA9614H

SYMBOL	PIN	EQUIVALENT CIRCUIT	DESCRIPTION
RECTL	40	<p>MLD041</p>	Rectifier DC decoupling left.
DETL	41	<p>MLD042</p>	Attack/recovery timing left.
V _{ref}	42	<p>MLD043</p>	Noise filtering of 3.8 V reference voltage (external capacitor required for filtering).
V _{SSA1}	43		Analog ground 1 for LF circuits.
DETR	44	<p>MLD044</p>	Attack/recovery timing right.
RECTR	45	<p>MLD045</p>	Rectifier DC decoupling right.

Audio processor for VHS hi-fi
and linear audio

TDA9614H

SYMBOL	PIN	EQUIVALENT CIRCUIT	DESCRIPTION
EMPHR	46	<p>MLD046</p>	Total emphasis right (240 to 20 μs).
DCREFR	47		DC reference right.
DCFBR	48		DC feedback right.
RFIX	49	<p>MLD047</p>	Fixed bias current generation circuit by using an external 180 kΩ resistor to ground.
V _{DDA1}	50		Analog supply voltage 1 for LF circuits (+12 V).
AFNR	51	<p>MLD048</p>	Audio output from noise reduction of right channel (record and loop-through) or audio input for noise reduction of right channel (playback).

Audio processor for VHS hi-fi
and linear audio

TDA9614H

SYMBOL	PIN	EQUIVALENT CIRCUIT	DESCRIPTION
AFMR	52		<p>Audio input for audio clipper of right channel (record and loop-through) or audio output from sample-and-hold (playback).</p>
RCCOR	53		<p>Voltage-to-current transfer for right channel oscillator by means of an external resistor to ground.</p>
V _{SSA2}	54		<p>Analog ground 2 for HF circuits.</p>
RBPF	55		<p>Bias current generation for the internal band-pass filters by means of an external resistor to ground.</p>

Audio processor for VHS hi-fi
and linear audio

TDA9614H

SYMBOL	PIN	EQUIVALENT CIRCUIT	DESCRIPTION
FMOUT	56	<p>MLD052</p>	FM output.
FMIN	57	<p>MLD053</p>	FM input.
V _D DA2	58		Analog supply voltage 2 for HF circuits (+5 V).
RCCOL	59	<p>MLD054</p>	Voltage-to-current transfer for left channel oscillator by means of an external resistor to ground.
ENVOUT	60	<p>MLD055</p>	Level detector output (external capacitor required for filtering).
HID	61	<p>MLD056</p>	Head Identification Pulse (HID) input for sample-and-hold circuits.

Audio processor for VHS hi-fi
and linear audio

TDA9614H

SYMBOL	PIN	EQUIVALENT CIRCUIT	DESCRIPTION
CMUTE	62		<p>Mute timing (external capacitor required for playback mute).</p>
AFML	63		<p>Audio input for audio clipper of left channel (record and loop-through) or audio output from sample-and-hold circuit of left channel (playback).</p>
AFNL	64		<p>Audio output from noise reduction of left channel (record and loop-through) or audio input for noise reduction of left channel (playback).</p>

Audio processor for VHS hi-fi and linear audio

TDA9614H

12 TEST AND APPLICATION INFORMATION

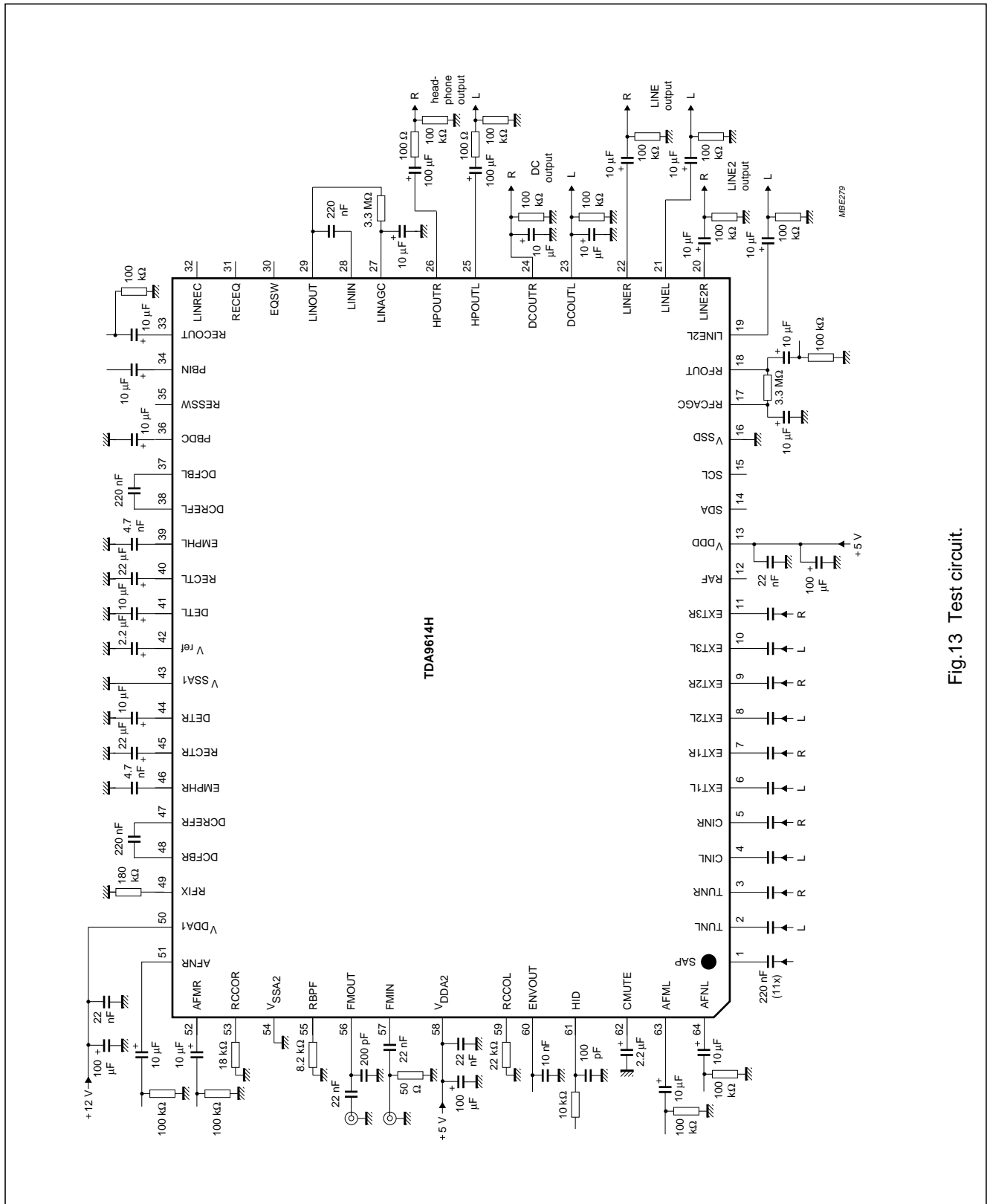

Fig.13 Test circuit.

Audio processor for VHS hi-fi and linear audio

TDA9614H

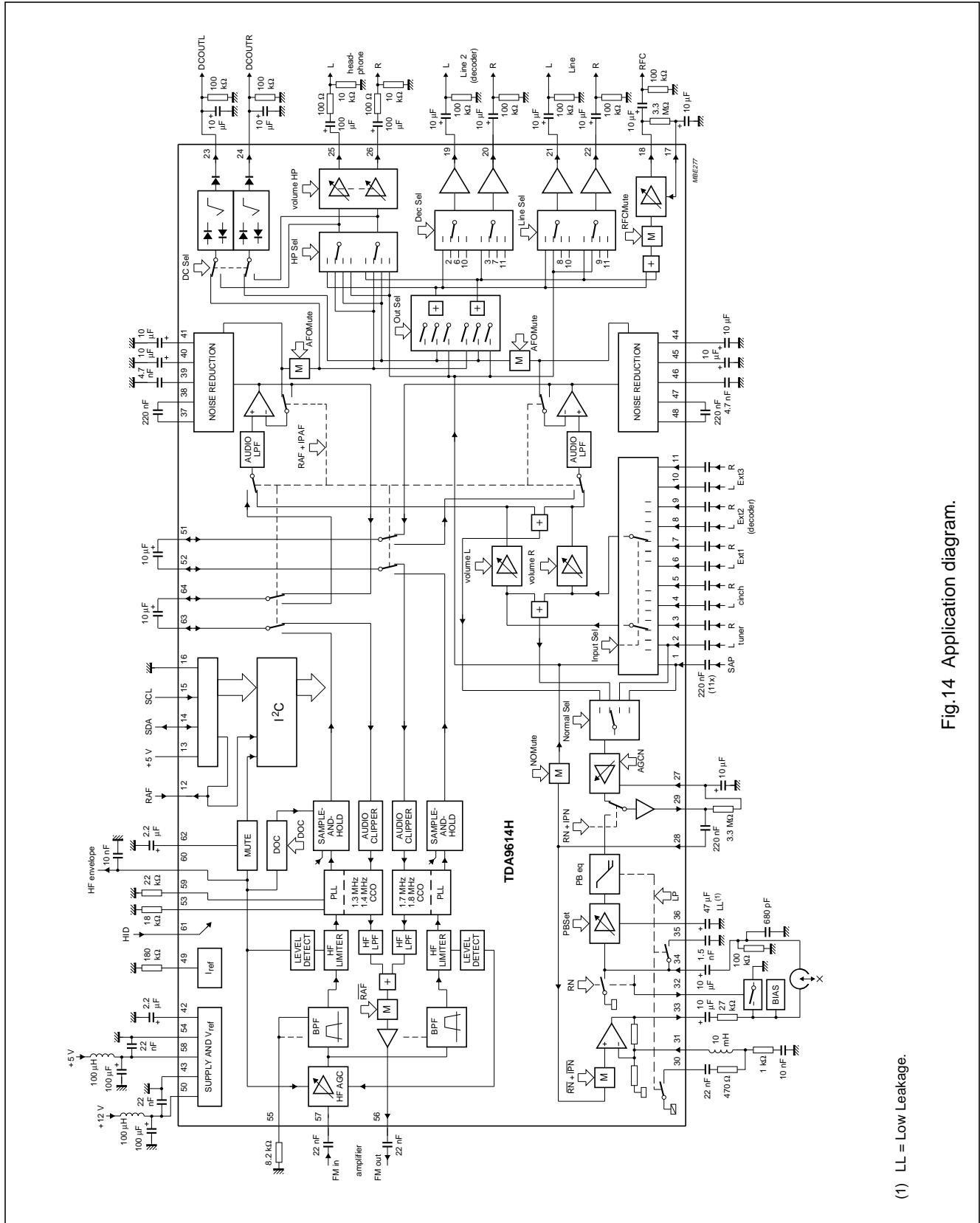

Fig.14 Application diagram.

Audio processor for VHS hi-fi and linear audio

TDA9614H

12.1 RAF I/O (pin 12)

The status of the I²C RAF bit is output (RAF = HIGH; record). This output can be used to switch the audio FM head amplifier to playback and record. If accurate fast switching of the TDA9614H is needed, this pin can also be used as input. Thereby overruling the I²C RAF bit. To make this possible the RAF output is current limited.

When using the RAF pin as output, no more than 35 μ A (LOW) and 185 μ A (HIGH) current may be drawn from this pin to assure that the mode of the TDA9614H is not changed.

When using the RAF pin as input, the voltage source used must be capable of delivering at least 345 μ A (forced HIGH; >3.5 V) or sinking at least 65 μ A (forced LOW; <1.5 V).

12.2 RCCOL, RCCOR, RBPF and RFIX (pins 59, 53, 55 and 49)

The external resistors to ground at pins RCCOL, RCCOR, RBPF and RFIX must have a tolerance of 5%. This is necessary to guarantee correct functioning of the IC. The temperature coefficient of the external resistors at RCCOL, RCCOR and RBPF have a direct influence on the related frequencies of the on-chip oscillators and bandpass filters.

Audio processor for VHS hi-fi and linear audio

TDA9614H

13 PACKAGE OUTLINE

QFP64: plastic quad flat package; 64 leads (lead length 1.95 mm); body 14 x 20 x 2.8 mm

SOT319-2

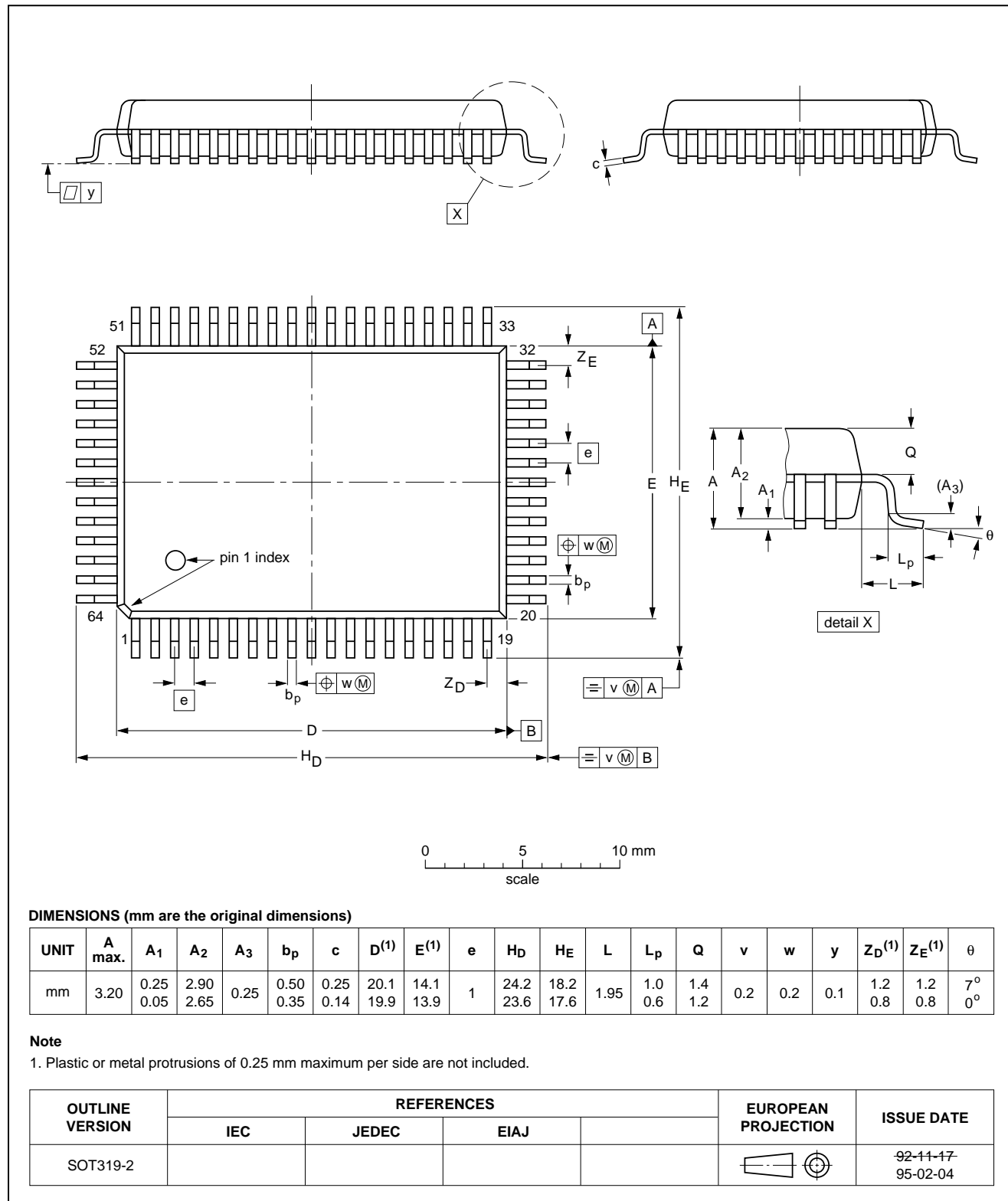

Audio processor for VHS hi-fi and linear audio

TDA9614H

14 SOLDERING

14.1 Plastic quad flat packages

14.1.1 BY WAVE

During placement and before soldering, the component must be fixed with a droplet of adhesive. After curing the adhesive, the component can be soldered. The adhesive can be applied by screen printing, pin transfer or syringe dispensing.

Maximum permissible solder temperature is 260 °C, and maximum duration of package immersion in solder bath is 10 s, if allowed to cool to less than 150 °C within 6 s. Typical dwell time is 4 s at 250 °C.

A modified wave soldering technique is recommended using two solder waves (dual-wave), in which a turbulent wave with high upward pressure is followed by a smooth laminar wave. Using a mildly-activated flux eliminates the need for removal of corrosive residues in most applications.

14.1.2 BY SOLDER PASTE REFLOW

Reflow soldering requires the solder paste (a suspension of fine solder particles, flux and binding agent) to be applied to the substrate by screen printing, stencilling or pressure-syringe dispensing before device placement.

Several techniques exist for reflowing; for example, thermal conduction by heated belt, infrared, and vapour-phase reflow. Dwell times vary between 50 and 300 s according to method. Typical reflow temperatures range from 215 to 250 °C.

Preheating is necessary to dry the paste and evaporate the binding agent. Preheating duration: 45 min at 45 °C.

14.1.3 REPAIRING SOLDERED JOINTS (BY HAND-HELD SOLDERING IRON OR PULSE-HEATED SOLDER TOOL)

Fix the component by first soldering two, diagonally opposite, end pins. Apply the heating tool to the flat part of the pin only. Contact time must be limited to 10 s at up to 300 °C. When using proper tools, all other pins can be soldered in one operation within 2 to 5 s at between 270 and 320 °C. (Pulse-heated soldering is not recommended for SO packages.)

For pulse-heated solder tool (resistance) soldering of VSO packages, solder is applied to the substrate by dipping or by an extra thick tin/lead plating before package placement.

Audio processor for VHS hi-fi and linear audio

TDA9614H

15 DEFINITIONS

Data sheet status	
Objective specification	This data sheet contains target or goal specifications for product development.
Preliminary specification	This data sheet contains preliminary data; supplementary data may be published later.
Product specification	This data sheet contains final product specifications.
Limiting values	
Limiting values given are in accordance with the Absolute Maximum Rating System (IEC 134). Stress above one or more of the limiting values may cause permanent damage to the device. These are stress ratings only and operation of the device at these or at any other conditions above those given in the Characteristics sections of the specification is not implied. Exposure to limiting values for extended periods may affect device reliability.	
Application information	
Where application information is given, it is advisory and does not form part of the specification.	

16 LIFE SUPPORT APPLICATIONS

These products are not designed for use in life support appliances, devices, or systems where malfunction of these products can reasonably be expected to result in personal injury. Philips customers using or selling these products for use in such applications do so at their own risk and agree to fully indemnify Philips for any damages resulting from such improper use or sale.

17 PURCHASE OF PHILIPS I²C COMPONENTS



Purchase of Philips I²C components conveys a license under the Philips' I²C patent to use the components in the I²C system provided the system conforms to the I²C specification defined by Philips. This specification can be ordered using the code 9398 393 40011.

Philips Semiconductors – a worldwide company

Argentina: IEROD, Av. Juramento 1992 - 14.b, (1428)
BUENOS AIRES, Tel. (541)786 7633, Fax. (541)786 9367

Australia: 34 Waterloo Road, NORTH RYDE, NSW 2113,
Tel. (02)805 4455, Fax. (02)805 4466

Austria: Triester Str. 64, A-1101 WIEN, P.O. Box 213,
Tel. (01)60 101-1236, Fax. (01)60 101-1211

Belgium: Postbus 90050, 5600 PB EINDHOVEN, The Netherlands,
Tel. (31)40 783 749, Fax. (31)40 788 399

Brazil: Rua do Rocio 220 - 5th floor, Suite 51,
CEP: 04552-903-SÃO PAULO-SP, Brazil.
P.O. Box 7383 (01064-970).
Tel. (011)821-2333, Fax. (011)829-1849

Canada: PHILIPS SEMICONDUCTORS/COMPONENTS:
Tel. (800) 234-7381, Fax. (708) 296-8556

Chile: Av. Santa María 0760, SANTIAGO,
Tel. (02)773 816, Fax. (02)777 6730

Colombia: IPRELENZO LTDA, Carrera 21 No. 56-17,
77621 BOGOTA, Tel. (571)249 7624/(571)217 4609,
Fax. (571)217 4549

Denmark: Prags Boulevard 80, PB 1919, DK-2300 COPENHAGEN S,
Tel. (032)88 2636, Fax. (031)57 1949

Finland: Sinikalliontie 3, FIN-02630 ESPOO,
Tel. (9)0-50261, Fax. (9)0-520971

France: 4 Rue du Port-aux-Vins, BP317,
92156 SURESNES Cedex,
Tel. (01)4099 6161, Fax. (01)4099 6427

Germany: P.O. Box 10 63 23, 20043 HAMBURG,
Tel. (040)3296-0, Fax. (040)3296 213.

Greece: No. 15, 25th March Street, GR 17778 TAVROS,
Tel. (01)4894 339/4894 911, Fax. (01)4814 240

Hong Kong: PHILIPS HONG KONG Ltd., 15/F Philips Ind. Bldg.,
24-28 Kung Yip St., KWAI CHUNG, N.T.,
Tel. (852)424 5121, Fax. (852)480 6960/480 6009

India: Philips INDIA Ltd, Shivsagar Estate, A Block,
Dr. Annie Besant Rd. Worli, Bombay 400 018
Tel. (022)4938 541, Fax. (022)4938 722

Indonesia: Philips House, Jalan H.R. Rasuna Said Kav. 3-4,
P.O. Box 4252, JAKARTA 12950,
Tel. (021)5201 122, Fax. (021)5205 189

Ireland: Newstead, Clonskeagh, DUBLIN 14,
Tel. (01)640 000, Fax. (01)640 200

Italy: PHILIPS SEMICONDUCTORS S.r.l.,
Piazza IV Novembre 3, 20124 MILANO,
Tel. (0039)2 6752 2531, Fax. (0039)2 6752 2557

Japan: Philips Bldg 13-37, Kohnan2-chome, Minato-ku, TOKYO 108,
Tel. (03)3740 5028, Fax. (03)3740 0580

Korea: (Republic of) Philips House, 260-199 Itaewon-dong,
Yongsan-ku, SEOUL, Tel. (02)794-5011, Fax. (02)798-8022

Malaysia: No. 76 Jalan Universiti, 46200 PETALING JAYA,
SELANGOR, Tel. (03)750 5214, Fax. (03)757 4880

Mexico: 5900 Gateway East, Suite 200, EL PASO, TX 79905,
Tel. 9-5(800)234-7381, Fax. (708)296-8556

Netherlands: Postbus 90050, 5600 PB EINDHOVEN, Bldg. VB
Tel. (040)783749, Fax. (040)788399

New Zealand: 2 Wagener Place, C.P.O. Box 1041, AUCKLAND,
Tel. (09)849-4160, Fax. (09)849-7811

Norway: Box 1, Manglerud 0612, OSLO,
Tel. (022)74 8000, Fax. (022)74 8341

Pakistan: Philips Electrical Industries of Pakistan Ltd.,
Exchange Bldg. ST-2/A, Block 9, KDA Scheme 5, Clifton,
KARACHI 75600, Tel. (021)587 4641-49,
Fax. (021)577035/5874546.

Philippines: PHILIPS SEMICONDUCTORS PHILIPPINES Inc,
106 Valero St. Salcedo Village, P.O. Box 2108 MCC, MAKATI,
Metro MANILA, Tel. (02)810 0161, Fax. (02)817 3474

Portugal: PHILIPS PORTUGUESA, S.A.,
Rua dr. António Loureiro Borges 5, Arquiparque - Miraflores,
Apartado 300, 2795 LINDA-A-VELHA,
Tel. (01)4163160/4163333, Fax. (01)4163174/4163366.

Singapore: Lorong 1, Toa Payoh, SINGAPORE 1231,
Tel. (65)350 2000, Fax. (65)251 6500

South Africa: S.A. PHILIPS Pty Ltd.,
195-215 Main Road Martindale, 2092 JOHANNESBURG,
P.O. Box 7430 Johannesburg 2000,
Tel. (011)470-5911, Fax. (011)470-5494.

Spain: Balmes 22, 08007 BARCELONA,
Tel. (03)301 6312, Fax. (03)301 42 43

Sweden: Kottbygatan 7, Akalla. S-164 85 STOCKHOLM,
Tel. (0)8-632 2000, Fax. (0)8-632 2745

Switzerland: Allmendstrasse 140, CH-8027 ZÜRICH,
Tel. (01)488 2211, Fax. (01)481 77 30

Taiwan: PHILIPS TAIWAN Ltd., 23-30F, 66, Chung Hsiao West
Road, Sec. 1. Taipei, Taiwan ROC, P.O. Box 22978,
TAIPEI 100, Tel. (02)388 7666, Fax. (02)382 4382.

Thailand: PHILIPS ELECTRONICS (THAILAND) Ltd.,
209/2 Sanpavuth-Bangna Road Prakanong,
Bangkok 10260, THAILAND,
Tel. (662)398-0141, Fax. (662)398-3319.

Turkey: Talatpasa Cad. No. 5, 80640 GÜLTEPE/ISTANBUL,
Tel. (0212)279 27 70, Fax. (0212)282 67 07

United Kingdom: Philips Semiconductors LTD.,
276 Bath Road, Hayes, MIDDLESEX UB3 5BX,
Tel. (0181)730-5000, Fax. (0181)754-8421

United States: 811 East Arques Avenue, SUNNYVALE,
CA 94088-3409, Tel. (800)234-7381, Fax. (708)296-8556

Uruguay: Coronel Mora 433, MONTEVIDEO,
Tel. (02)70-4044, Fax. (02)92 0601

Internet: <http://www.semiconductors.philips.com/ps/>

For all other countries apply to: Philips Semiconductors,
International Marketing and Sales, Building BE-p,
P.O. Box 218, 5600 MD, EINDHOVEN, The Netherlands,
Telex 35000 phtcnl, Fax. +31-40-724825

SCD38

© Philips Electronics N.V. 1995

All rights are reserved. Reproduction in whole or in part is prohibited without the prior written consent of the copyright owner.

The information presented in this document does not form part of any quotation or contract, is believed to be accurate and reliable and may be changed without notice. No liability will be accepted by the publisher for any consequence of its use. Publication thereof does not convey nor imply any license under patent- or other industrial or intellectual property rights.

Printed in The Netherlands

513061/1500/01/pp60

Date of release: 1995 Mar 21

Document order number:

9397 750 00047

Philips Semiconductors



PHILIPS