



# STTA9012TV1/2

## TURBOSWITCH™ "A". ULTRA-FAST HIGH VOLTAGE DIODE

### MAIN PRODUCTS CHARACTERISTICS

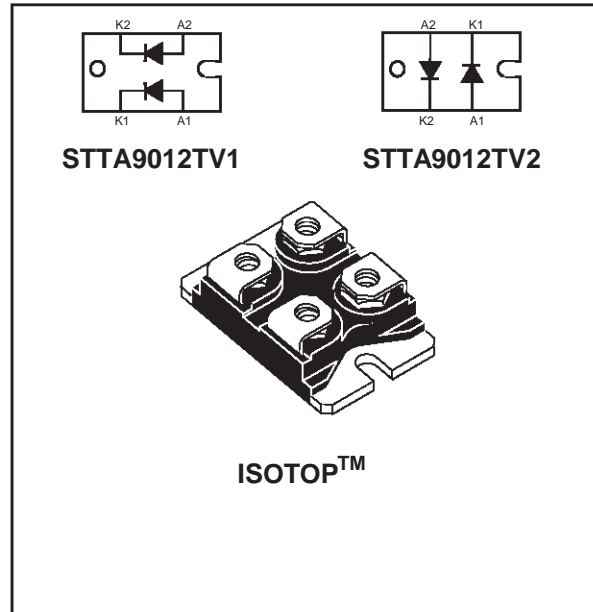
$I_{F(AV)}$	45A
$V_{RRM}$	1200V
$t_{rr}$ (typ)	65ns
$V_F$ (max)	1.85V

### FEATURES AND BENEFITS

- ULTRA-FAST, SOFT AND NOISE-FREE RECOVERY.
- VERY LOW OVERALL POWER LOSSES IN BOTH THE DIODE AND THE COMPANION TRANSISTOR.
- HIGH FREQUENCY AND/OR HIGH PULSED CURRENT OPERATIONS.

### DESCRIPTION

TURBOSWITCH 1200V drastically cuts losses in all high voltage operations which require extremely fast, soft and noise-free power diodes. Due to their optimized switching performances they also highly decrease power losses in any associated switching IGBT or MOSFET in all "Freewheel Mode" operations.



They are particularly suitable in Motor Control circuitries, or in the primary of SMPS as snubber, clamping or demagnetizing diodes, and also at the secondary of SMPS as high voltage rectifier diodes.

### ABSOLUTE MAXIMUM RATINGS

Symbol	Parameter	Value	Unit
$V_{RRM}$	Repetitive peak reverse voltage	1200	V
$V_{RSM}$	Non repetitive peak reverse voltage	1200	V
$I_{F(RMS)}$	RMS forward current	150	A
$I_{FRM}$	Repetitive peak forward current ( $t_p = 5 \mu s$ , $F = 5 kHz$ )	900	A
$T_j$	Maximum operating junction temperature	150	°C
$T_{stg}$	Storage temperature	-65 to 150	°C

ISOTOP and TURBOSWITCH are trademarks of STMicroelectronics.

## STTA9012TV1/2

### THERMAL AND POWER DATA

Symbol	Parameter	Conditions	Value	Unit
$R_{th(j-c)}$	Junction to case thermal resistance	Per diode	0.85	°C/W
		Total	0.48	
		Coupling	0.1	
$P_1$	Conduction power dissipation (see fig. 6)	$I_{F(AV)} = 45A$ $\delta = 0.5$ Per diode $T_c = 70^\circ C$	94	W
$P_{max}$	Total power dissipation $P_{max} = P_1 + P_3$ ( $P_3 = 10\% P_1$ )	Per diode $T_c = 62^\circ C$	104	W

### STATIC ELECTRICAL CHARACTERISTICS (see Fig.6)

Symbol	Parameter	Test Conditions	Min	Typ	Max	Unit
$V_F$ *	Forward voltage drop	$I_F = 45A$ $T_j = 25^\circ C$ $T_j = 125^\circ C$		1.3	2.05 1.85	V
$I_R$ **	Reverse leakage current	$V_R = 0.8$ $\times V_{RRM}$ $T_j = 25^\circ C$ $T_j = 125^\circ C$		3	200 12	$\mu A$ mA
$V_{to}$	Threshold voltage	$T_j = 125^\circ C$			1.57	V
$R_d$	Dynamic resistance				6	m $\Omega$

Test pulses widths : \*  $t_p = 380 \mu s$ ,  $\delta < 2\%$

\*\*  $t_p = 5 ms$ ,  $\delta < 2\%$

### DYNAMIC ELECTRICAL CHARACTERISTICS

#### TURN-OFF SWITCHING (see Fig.7)

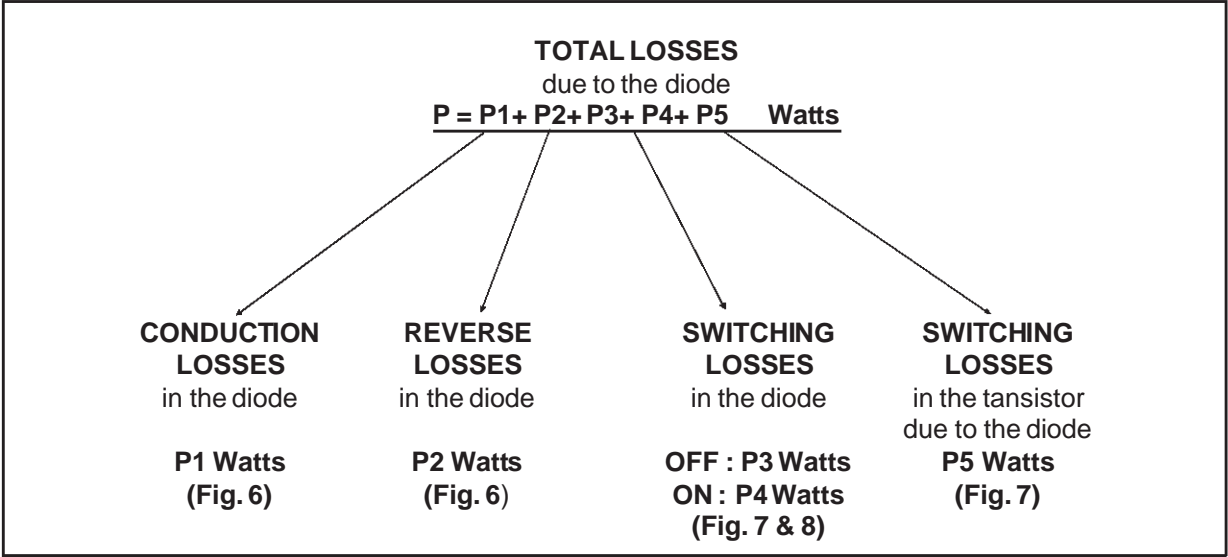
Symbol	Parameter	Test Conditions	Min	Typ	Max	Unit
$t_{rr}$	Reverse recovery time	$T_j = 25^\circ C$ $I_F = 0.5 A$ $I_R = 1A$ $I_{rr} = 0.25A$ $I_F = 1 A$ $di_F/dt = -50A/\mu s$ $V_R = 30V$		65	115	ns
$I_{RM}$	Maximum reverse recovery current	$T_j = 125^\circ C$ $V_R = 600V$ $I_F = 45A$ $di_F/dt = -360 A/\mu s$ $di_F/dt = -500 A/\mu s$		50	60	A
S factor	Softness factor	$T_j = 125^\circ C$ $V_R = 600V$ $I_F = 45A$ $di_F/dt = -500 A/\mu s$		1.2		-

#### TURN-ON SWITCHING (see Fig.8)

Symbol	Parameter	Test Conditions	Min	Typ	Max	Unit
$t_{fr}$	Forward recovery time	$T_j = 25^\circ C$ $I_F = 45 A$ , $di_F/dt = 360 A/\mu s$ measured at $1.1 \times V_{Fmax}$			900	ns
$V_{Fp}$	Peak forward voltage	$T_j = 25^\circ C$ $I_F = 45A$ , $di_F/dt = 360 A/\mu s$ $I_F = 45A$ , $di_F/dt = 500 A/\mu s$		30	30	V

**APPLICATION DATA**

The 1200V TURBOSWITCH series has been designed to provide the lowest overall power losses in all high frequency or high pulsed current operations. In such applications (Fig 1 to 5), the way of calculating the power losses is given below :



**Fig. 1 : "FREEWHEEL" MODE.**

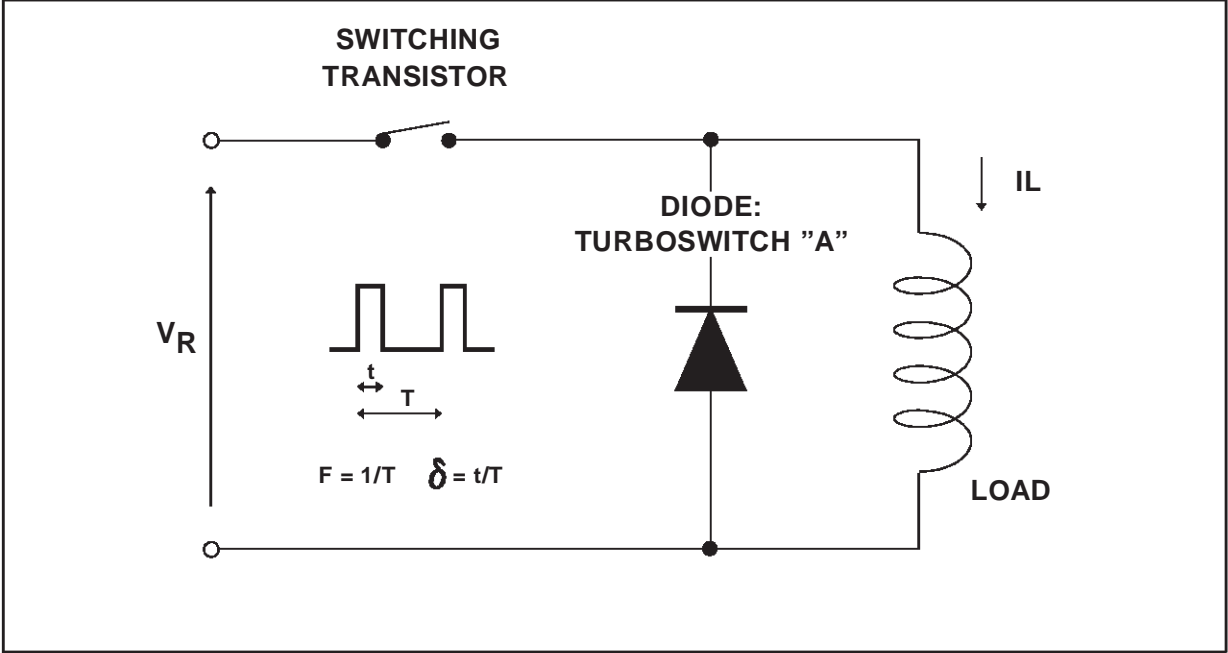


Fig. 2 : SNUBBER DIODE.

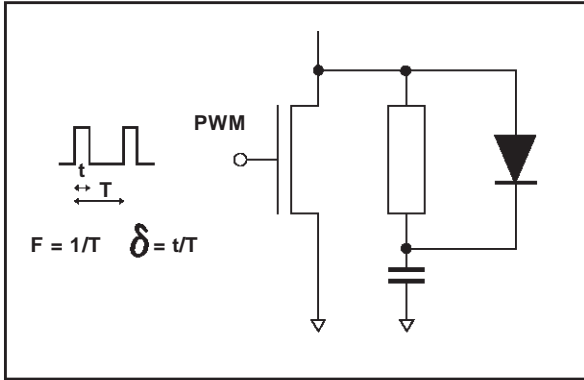


Fig. 3 : CLAMPING DIODE.

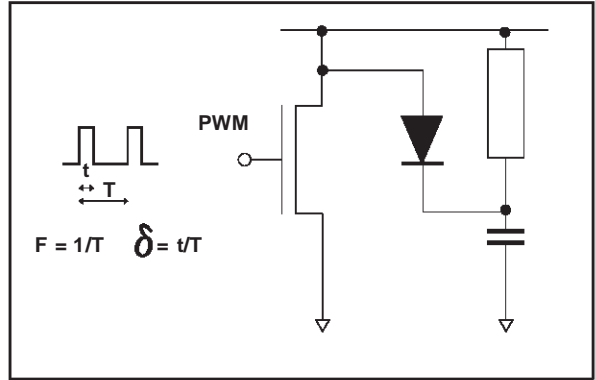


Fig. 4 : DEMAGNETIZING DIODE.

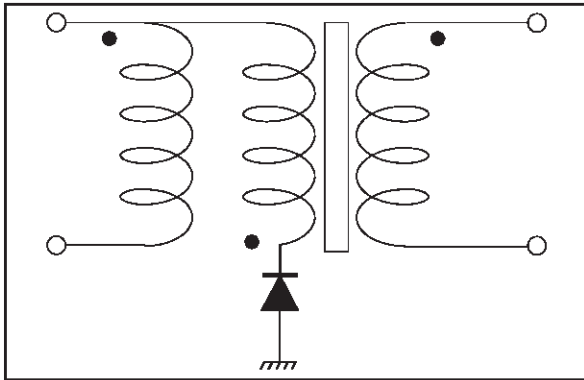
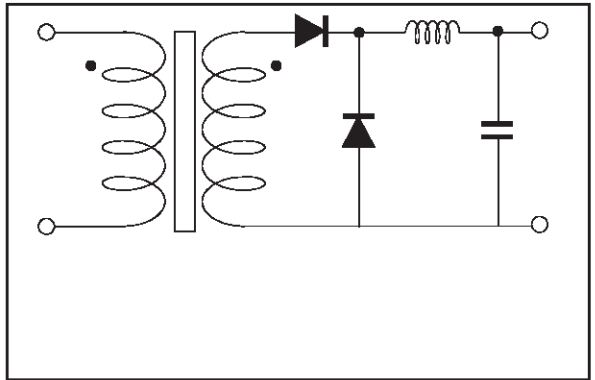
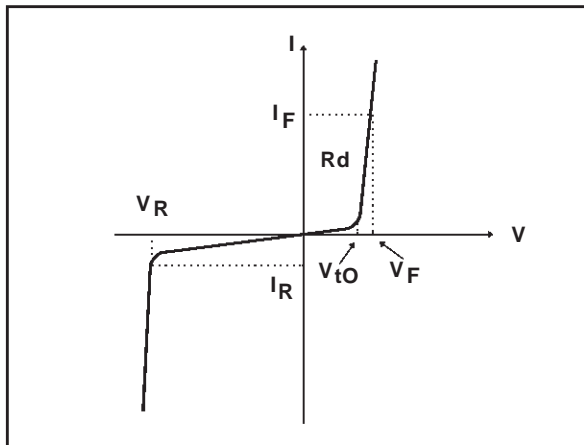


Fig. 5 : RECTIFIER DIODE.



STATIC & DYNAMIC CHARACTERISTICS . POWER LOSSES .

Fig. 6: STATIC CHARACTERISTICS



**Conduction losses :**

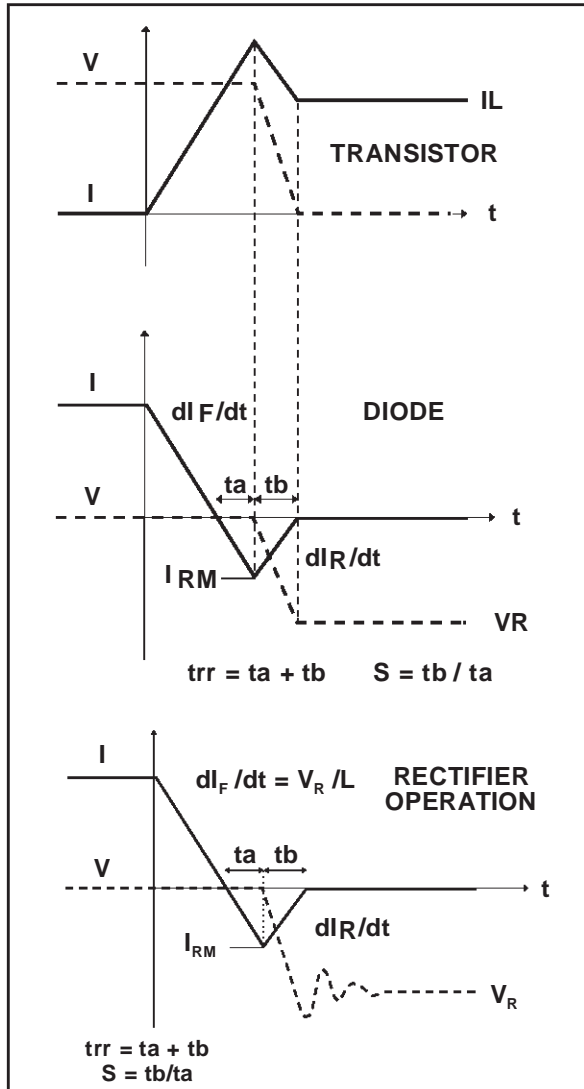
$$P1 = V_{t0} \cdot I_{F(AV)} + R_d \cdot I_{F(RMS)}^2$$

**Reverse losses :**

$$P2 = V_R \cdot I_R \cdot (1 - \delta)$$

APPLICATION DATA (Cont'd)

Fig. 7: TURN-OFF CHARACTERISTICS



**Turn-on losses:**  
(in the transistor, due to the diode)

$$P5 = \frac{V_R \times I_{RM}^2 \times (3 + 2 \times S) \times F}{6 \times dI_F/dt} + \frac{V_R \times I_{RM} \times I_L \times (S + 2) \times F}{2 \times dI_F/dt}$$

**Turn-off losses (in the diode):**

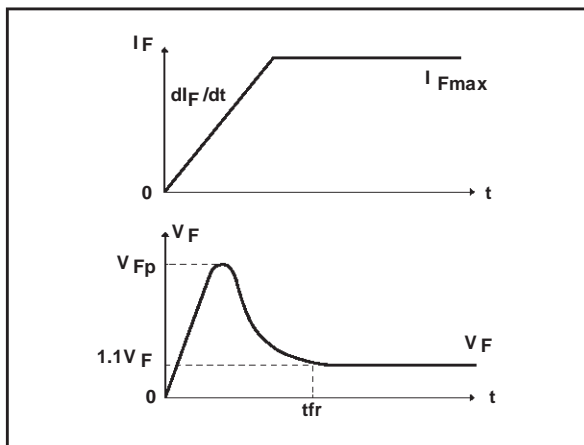
$$P3 = \frac{V_R \times I_{RM}^2 \times S \times F}{6 \times dI_F/dt}$$

**Turn-off losses:**  
(with non negligible serial inductance)

$$P3' = \frac{V_R \times I_{RM}^2 \times S \times F}{6 \times dI_F/dt} + \frac{L \times I_{RM}^2 \times F}{2}$$

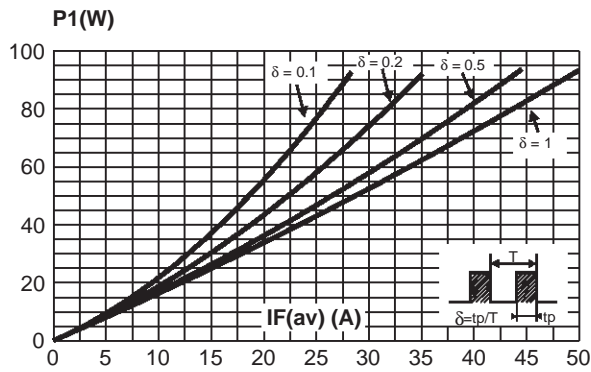
P3, P3' and P5 are suitable for power MOSFET and IGBT

Fig. 8: TURN-ON CHARACTERISTICS

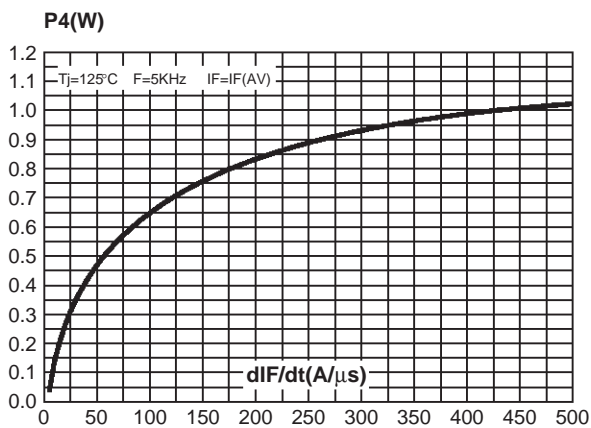


**Turn-on losses:**  
 $P4 = 0.4 (V_{FP} - V_F) \cdot I_{Fmax} \cdot t_{fr} \cdot F$

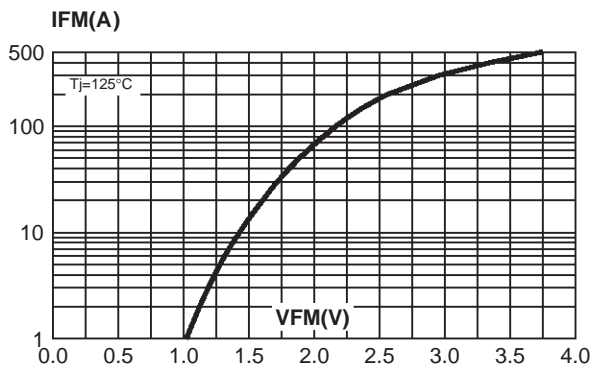
**Fig. 9:** Conduction losses versus average current (per diode).



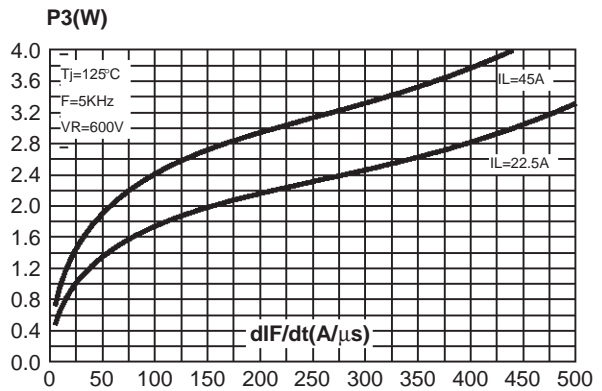
**Fig. 11:** Switching ON losses versus  $dIF/dt$ .



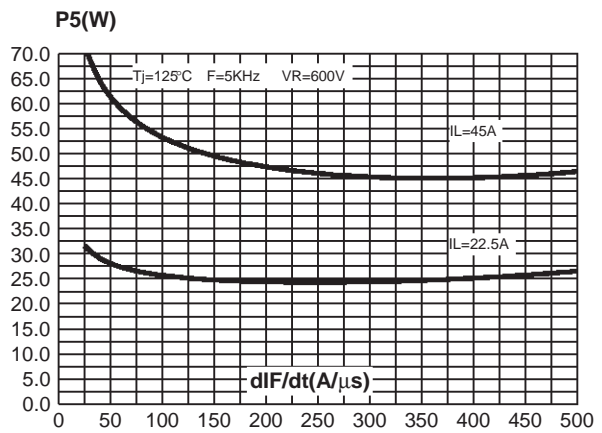
**Fig. 13:** Forward voltage drop versus forward current (maximum values, per diode).



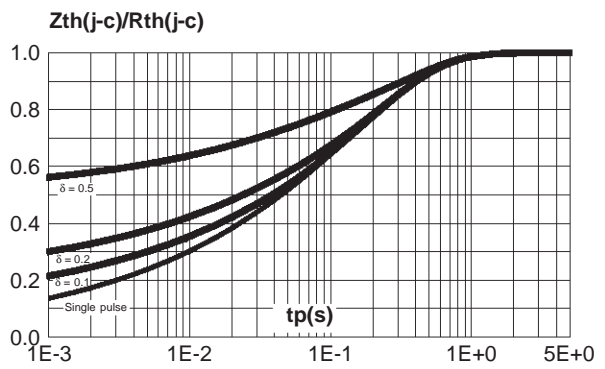
**Fig. 10:** Switching OFF losses versus  $dIF/dt$ .



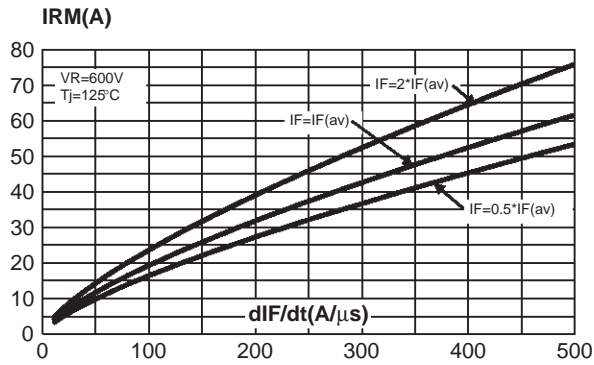
**Fig. 12:** Switching losses in transistor due to the diode.



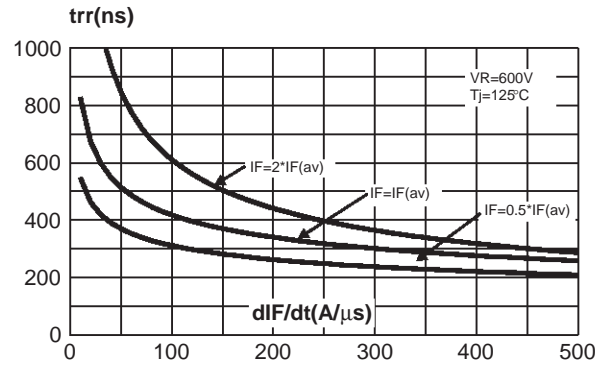
**Fig. 14:** Relative variation of thermal impedance junction to case versus pulse duration (per diode).



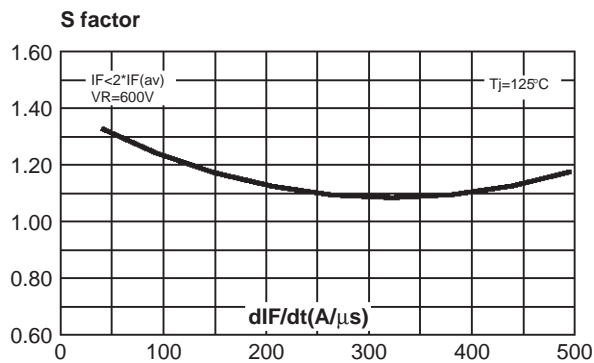
**Fig. 15:** Peak reverse recovery current versus  $dI_F/dt$  (90% confidence, per diode).



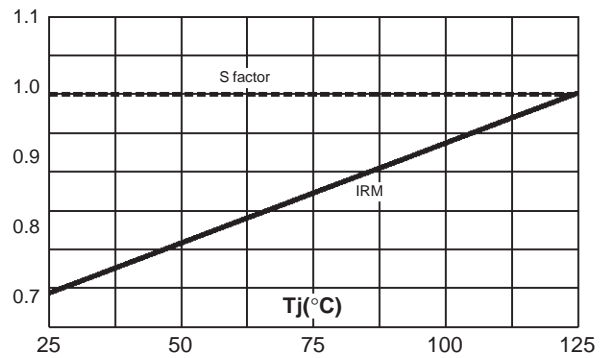
**Fig. 16:** Reverse recovery time versus  $dI_F/dt$  (90% confidence, per diode).



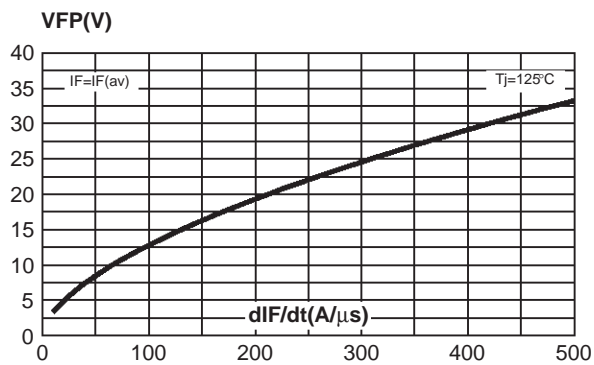
**Fig. 17:** Softness factor (tb/ta) versus  $dI_F/dt$  (typical values).



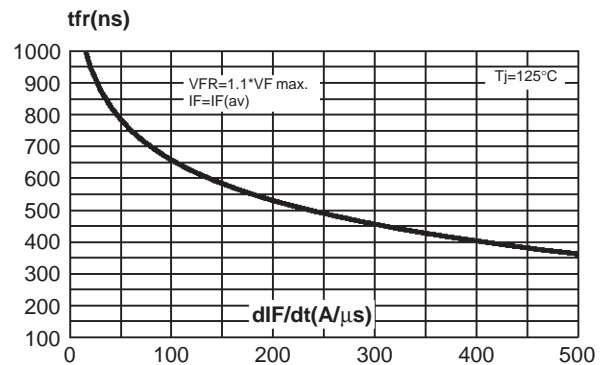
**Fig. 18:** Relative variation of dynamic parameters versus junction temperature (reference:  $T_j = 125^\circ C$ ).



**Fig. 19:** Transient peak forward voltage versus  $dI_F/dt$  (90% confidence, per diode).

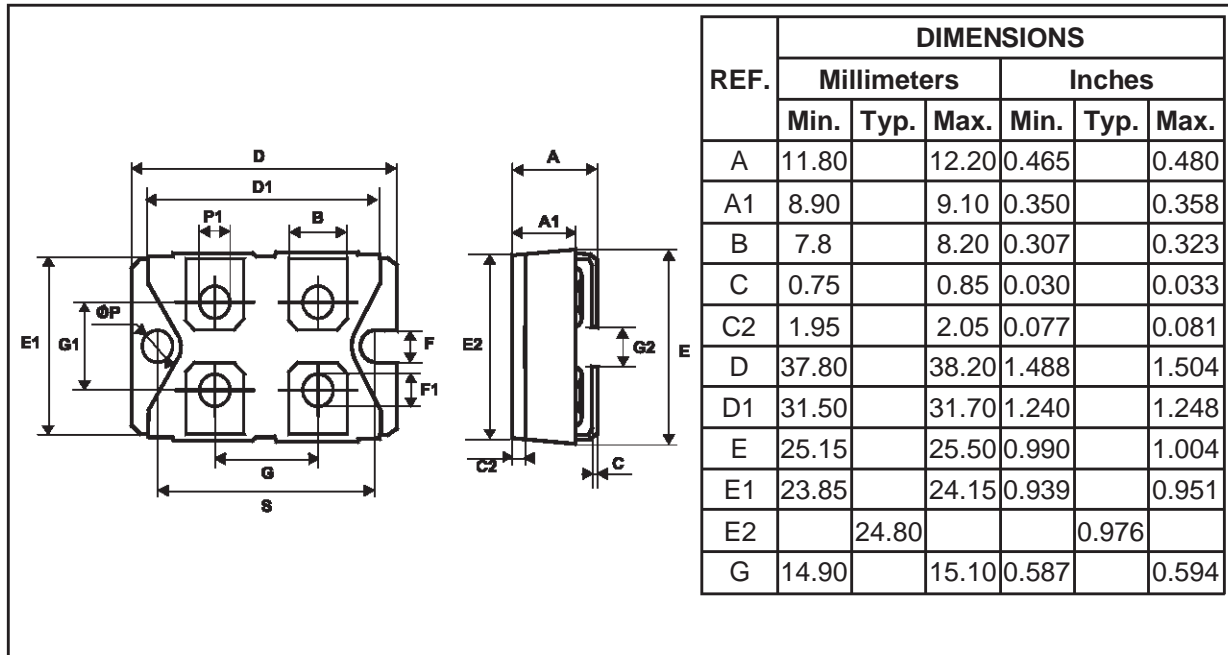


**Fig. 201:** Forward recovery time versus  $dI_F/dt$  (90% confidence, per diode).



# STTA9012TV1/2

## PACKAGE MECHANICAL DATA ISOTOP



- **Marking:** Type number
- **Cooling method:** C
- **Weight:** 28 g (without screws)
- **Electric isolation:** 2500V<sub>(RMS)</sub>
- **Capacitance:** < 45 pF
- **Inductance:** < 5 nH
- **Recommended torque value:** 1.3 N.m (MAX 1.5 N.m) for the 6 x M4 screws. (2 x M4 screws recommended for mounting the package on the heatsink and the 4 screws given with the screw version).
- **The screws supplied with the package are adapted for mounting on a board (or other types of terminals) with a thickness of 0.6 mm min and 2.2 mm max.**

Information furnished is believed to be accurate and reliable. However, STMicroelectronics assumes no responsibility for the consequences of use of such information nor for any infringement of patents or other rights of third parties which may result from its use. No license is granted by implication or otherwise under any patent or patent rights of STMicroelectronics. Specifications mentioned in this publication are subject to change without notice. This publication supersedes and replaces all information previously supplied. STMicroelectronics products are not authorized for use as critical components in life support devices or systems without express written approval of STMicroelectronics.

The ST logo is a registered trademark of STMicroelectronics

© 1998 STMicroelectronics - Printed in Italy - All rights reserved.

STMicroelectronics GROUP OF COMPANIES

Australia - Brazil - Canada - China - France - Germany - Italy - Japan - Korea - Malaysia - Malta - Mexico - Morocco - The Netherlands - Singapore - Spain - Sweden - Switzerland - Taiwan - Thailand - United Kingdom - U.S.A.