



STPS2045CT/CF/CG

POWER SCHOTTKY RECTIFIER

MAIN PRODUCT CHARACTERISTICS

$I_{F(AV)}$	2 x 10 A
V_{RRM}	45 V
V_F	0.57 V

FEATURES AND BENEFITS

- VERY SMALL CONDUCTION LOSSES
- NEGLIGIBLE SWITCHING LOSSES
- EXTREMELY FAST SWITCHING
- LOW FORWARD VOLTAGE DROP
- LOW THERMAL RESISTANCE
- INSULATED PACKAGE:
Insulating voltage = 2000V DC
Capacitance = 12pF
- SMD PACKAGE

DESCRIPTION

Dual center tap Schottky rectifier suited for Switch-Mode Power Supply and high frequency DC to DC converters.

This device is especially intended for use in low voltage, high frequency inverters, free wheeling and polarity protection applications.

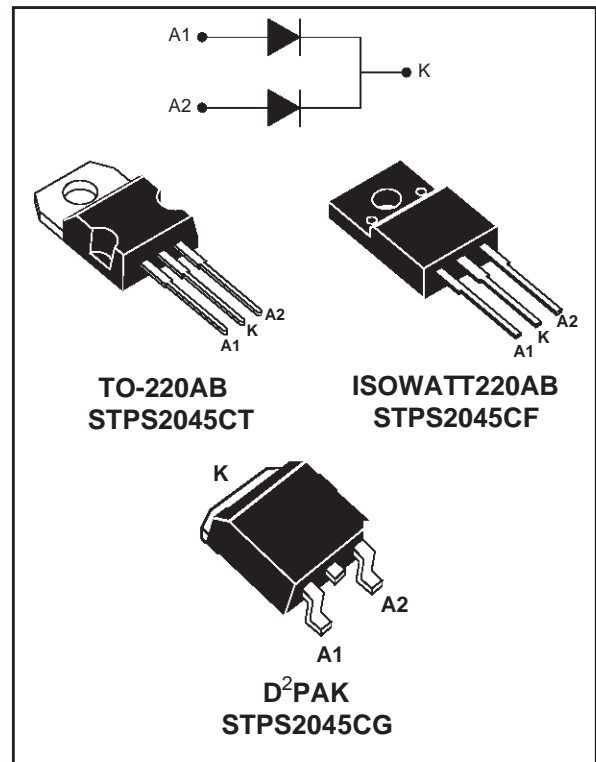

ABSOLUTE RATINGS (limiting values)

Symbol	Parameter			Value	Unit	
V_{RRM}	Repetitive peak reverse voltage			45	V	
$I_{F(AV)}$	Average forward current $\delta = 0.5$	TO-220AB/ D ² PAK	$T_c = 135^\circ\text{C}$	Per diode	10	A
		ISOWATT220AB	$T_c = 120^\circ\text{C}$	Per device	20	
$I_{F(RMS)}$	RMS forward current			30	A	
I_{FSM}	Surge non repetitive forward current		$t_p = 10\text{ ms}$ Sinusoidal	Per diode	180	A
I_{RRM}	Repetitive peak reverse current		$t_p = 2\ \mu\text{s}$ $F = 1\text{ KHz}$	Per diode	1	A
T_{stg}	Storage temperature range			-65 to +150	$^\circ\text{C}$	
T_j	Maximum junction temperature			150	$^\circ\text{C}$	
dV/dt	Critical rate of rise of reverse voltage			10000	V/ μs	

STPS2045CT/CF/CG

THERMAL RESISTANCES

Symbol	Parameter		Value	Unit	
R _{th(j-c)}	Junction to case	TO-220AB / D ² PAK	Per diode Total	2.2 1.3	°C/W
		ISOWATT220AB	Per diode Total	4.5 3.5	
R _{th(c)}	Coupling	TO-220AB / D ² PAK		0.3	°C/W
		ISOWATT220AB		2.5	

When the diodes 1 and 2 are used simultaneously:

$$\Delta T_j (\text{diode 1}) = P (\text{diode 1}) \times R_{TH} (\text{per diode}) + P (\text{diode 2}) \times R_{TH(C)}$$

STATIC ELECTRICAL CHARACTERISTICS (Per diode)

Symbol	Parameter	Tests Conditions		Min.	Typ.	Max.	Unit
I _R *	Reverse leakage current	T _j = 25°C	V _R = V _{RRM}			100	μA
		T _j = 125°C				15	mA
V _F **	Forward voltage drop	T _j = 25°C	I _F = 20 A			0.84	V
		T _j = 125°C	I _F = 20 A			0.72	
		T _j = 125°C	I _F = 10 A			0.57	

Pulse test : * t_p = 5 ms, δ < 2 %

** t_p = 380 μs, δ < 2%

To evaluate the conduction losses use the following equation :

$$P = 0.42 \times I_{F(AV)} + 0.015 I_{F(RMS)}^2$$

Fig. 1: Average forward power dissipation versus average forward current (per diode).

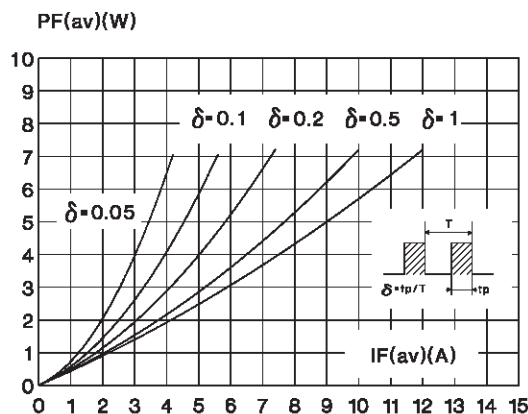

Fig. 2-1: Average current versus ambient temperature ($\delta=0.5$) (per diode) (TO-220AB and D²PAK).

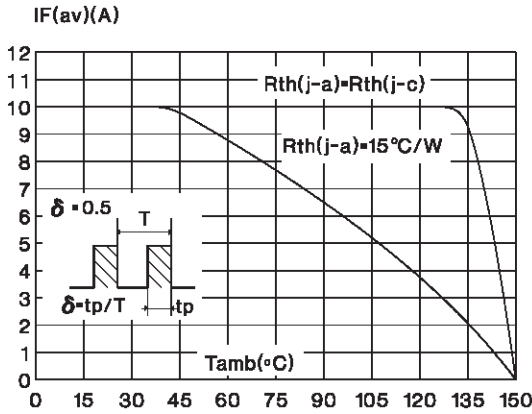

Fig. 2-2: Average current versus ambient temperature ($\delta=0.5$) (per diode) (ISOWATT220AB).

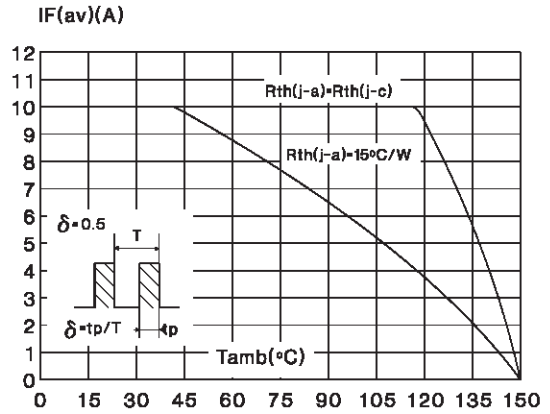

Fig. 3-1: Non repetitive surge peak forward current versus overload duration (maximum values) (per diode) (TO-220AB and D²PAK).

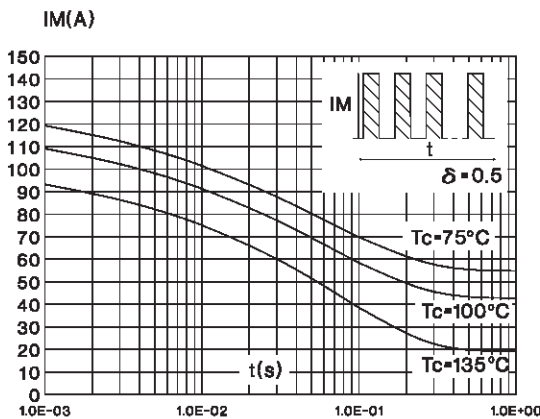

Fig. 3-2: Non repetitive surge peak forward current versus overload duration (maximum values) (per diode) (ISOWATT220AB).

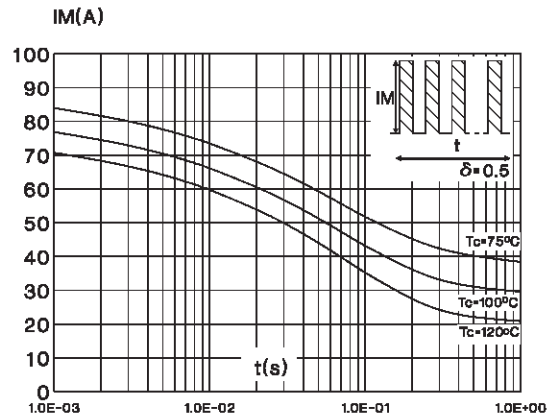

Fig. 4-1: Relative variation of thermal transient impedance junction to case versus pulse duration (TO-220AB and D²PAK).

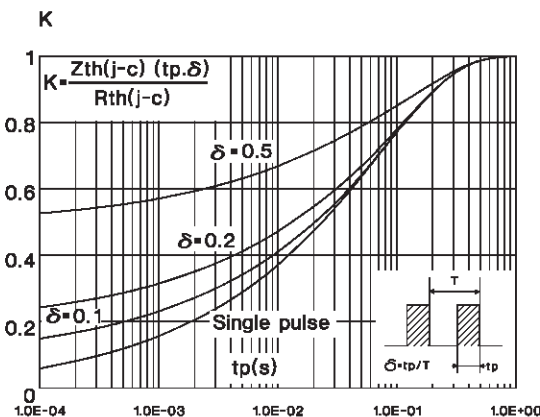
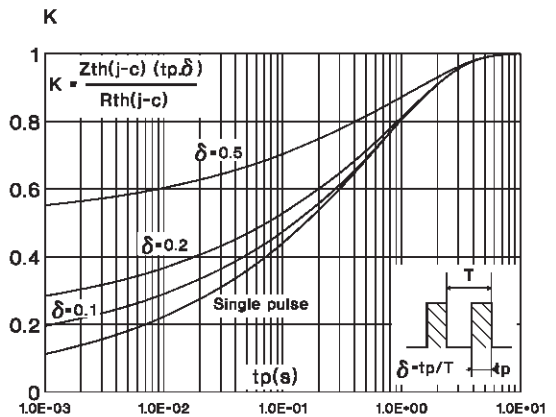

Fig. 4-2: Relative variation of thermal transient impedance junction to case versus pulse duration (ISOWATT220AB).



STPS2045CT/CF/CG

Fig. 5: Reverse leakage current versus reverse voltage applied (typical values) (per diode).

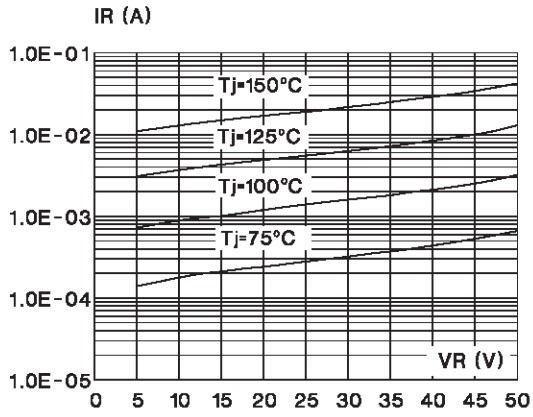

Fig. 6: Junction capacitance versus reverse voltage applied (typical values) (per diode).

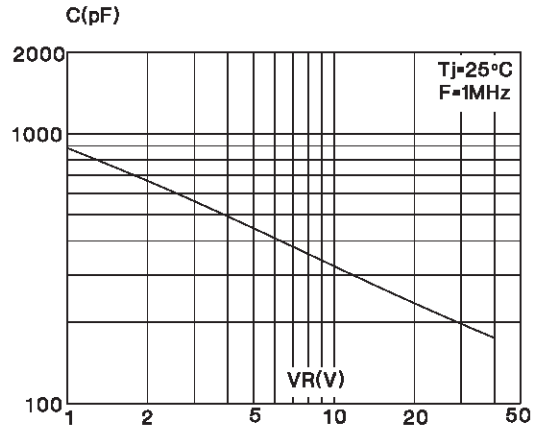
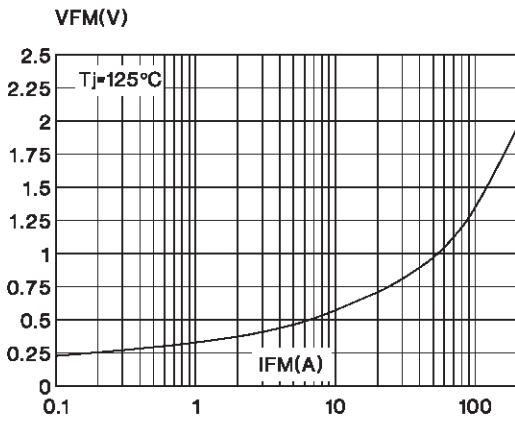
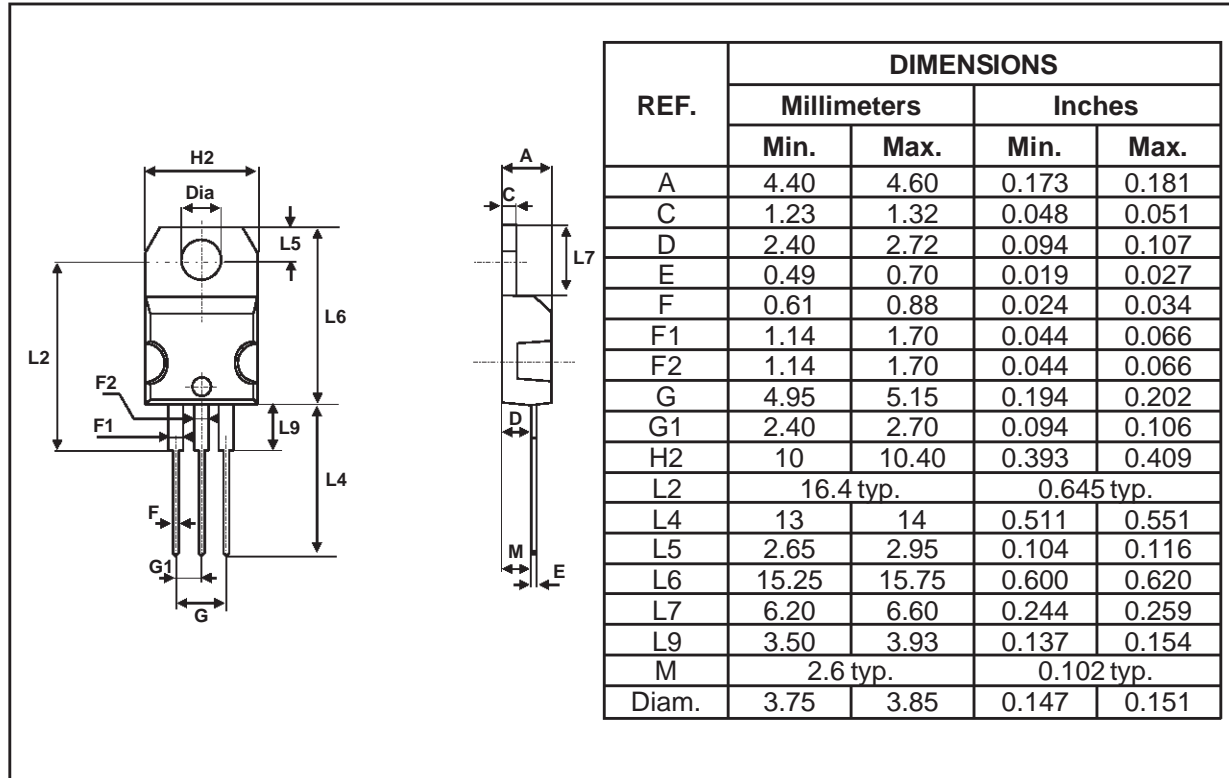

Fig. 7: Forward voltage drop versus forward current (maximum values) (per diode).



PACKAGE MECHANICAL DATA
TO-220AB



PACKAGE MECHANICAL DATA
ISOWATT220AB

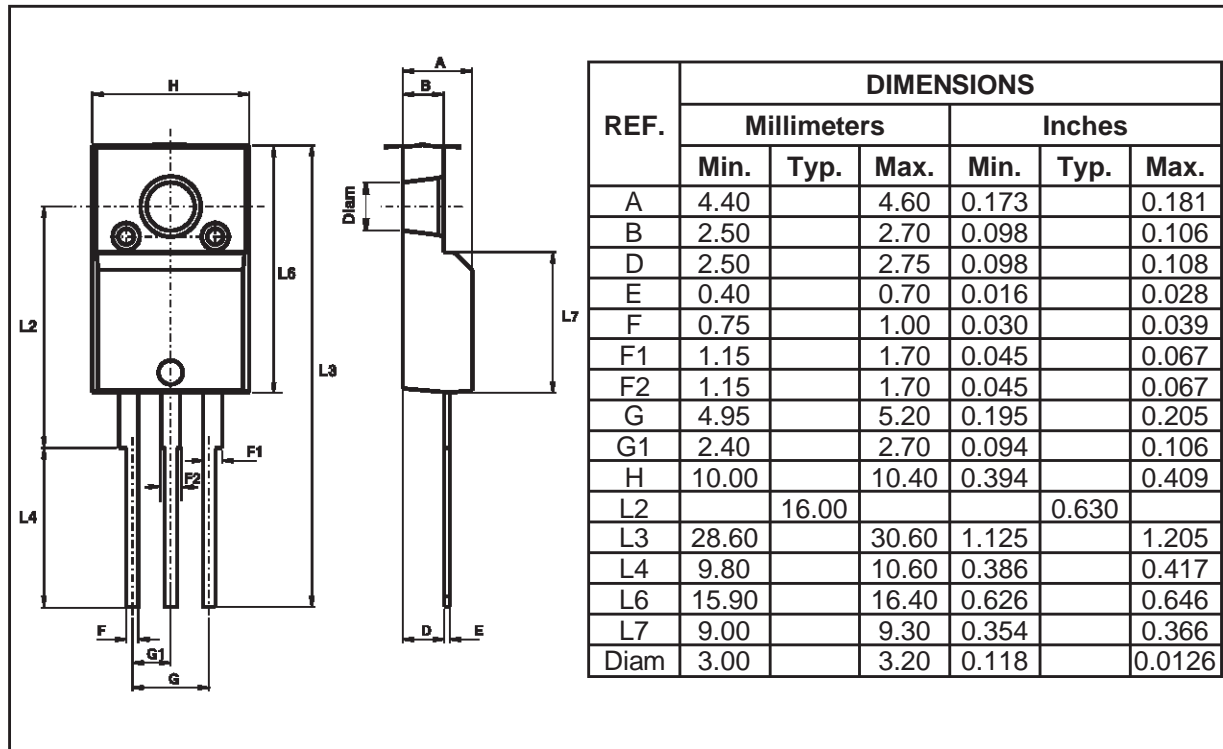

STPS2045CT/CF/CG

PACKAGE MECHANICAL DATA D²PAK

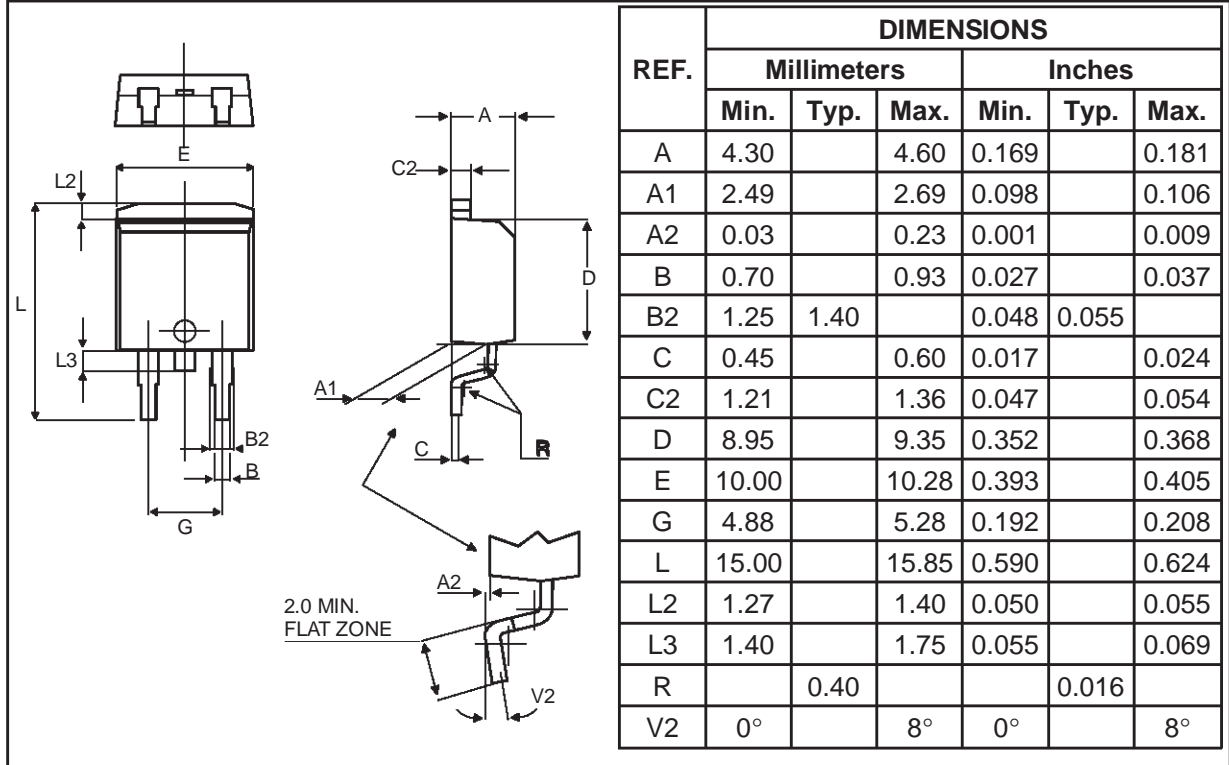

FOOTPRINT DIMENSIONS (in millimeters)

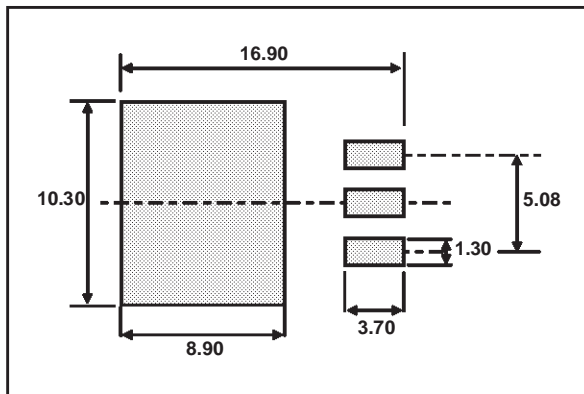

- **Marking:** Type number
- **Cooling method:** C
- **Weight:** 1.8 g.

Information furnished is believed to be accurate and reliable. However, STMicroelectronics assumes no responsibility for the consequences of use of such information nor for any infringement of patents or other rights of third parties which may result from its use. No license is granted by implication or otherwise under any patent or patent rights of STMicroelectronics. Specifications mentioned in this publication are subject to change without notice. This publication supersedes and replaces all information previously supplied. STMicroelectronics products are not authorized for use as critical components in life support devices or systems without express written approval of STMicroelectronics.

The ST logo is a registered trademark of STMicroelectronics

© 1998 STMicroelectronics - Printed in Italy - All rights reserved.

STMicroelectronics GROUP OF COMPANIES

Australia - Brazil - Canada - China - France - Germany - Italy - Japan - Korea - Malaysia - Malta - Mexico - Morocco - The Netherlands - Singapore - Spain - Sweden - Switzerland - Taiwan - Thailand - United Kingdom - U.S.A.