

**P-Channel Enhancement-Mode MOSFET**

**Product Summary**

V <sub>DS</sub> (V)	r <sub>DS(on)</sub> (Ω)	I <sub>D</sub> (A)
-30	0.040 @ V <sub>GS</sub> = -10 V	± 4.5
	0.070 @ V <sub>GS</sub> = -4.5 V	± 3.4

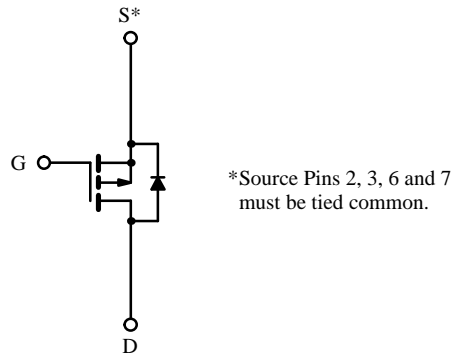
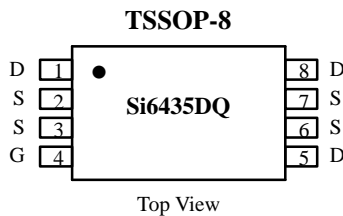

P-Channel MOSFET

**Absolute Maximum Ratings (T<sub>A</sub> = 25° C Unless Otherwise Noted)**

Parameter	Symbol	Limit	Unit
Drain-Source Voltage	V <sub>DS</sub>	-30	V
Gate-Source Voltage	V <sub>GS</sub>	± 20	
Continuous Drain Current (T <sub>J</sub> = 150° C) <sup>a</sup>	I <sub>D</sub>	T <sub>A</sub> = 25° C	± 4.5
		T <sub>A</sub> = 70° C	± 3.6
Pulsed Drain Current	I <sub>DM</sub>	± 30	A
Continuous Source Current (Diode Conduction) <sup>a</sup>	I <sub>S</sub>	-1.25	
Maximum Power Dissipation <sup>a</sup>	P <sub>D</sub>	T <sub>A</sub> = 25° C	1.5
		T <sub>A</sub> = 70° C	1.0
Operating Junction and Storage Temperature Range	T <sub>J</sub> , T <sub>stg</sub>	-55 to 150	°C

**Thermal Resistance Ratings**

Parameter	Symbol	Limit	Unit
Maximum Junction-to-Ambient <sup>a</sup>	R <sub>thJA</sub>	83	°C/W

Notes

a. Surface Mounted on FR4 Board, t ≤ 10 sec.

Subsequent updates to this data sheet may be obtained via facsimile by calling Siliconix FaxBack, 1-408-970-5600. Please request FaxBack document #1815. A SPICE Model data sheet is available for this product (FaxBack document #5139).

## Specifications ( $T_J = 25^\circ\text{C}$ Unless Otherwise Noted)

Parameter	Symbol	Test Condition	Min	Typ	Max	Unit
<b>Static</b>						
Gate Threshold Voltage	$V_{GS(th)}$	$V_{DS} = V_{GS}, I_D = -250 \mu\text{A}$	-1.0			V
Gate-Body Leakage	$I_{GSS}$	$V_{DS} = 0 \text{ V}, V_{GS} = \pm 20 \text{ V}$			$\pm 100$	nA
Zero Gate Voltage Drain Current	$I_{DSS}$	$V_{DS} = -30 \text{ V}, V_{GS} = 0 \text{ V}$			-1	$\mu\text{A}$
		$V_{DS} = -30 \text{ V}, V_{GS} = 0 \text{ V}, T_J = 70^\circ\text{C}$			-25	
On-State Drain Current <sup>a</sup>	$I_{D(on)}$	$V_{DS} = -5 \text{ V}, V_{GS} = -10 \text{ V}$	-30			A
		$V_{DS} = -5 \text{ V}, V_{GS} = -4.5 \text{ V}$	-7			
Drain-Source On-State Resistance <sup>a</sup>	$r_{DS(on)}$	$V_{GS} = -10 \text{ V}, I_D = -4.5 \text{ A}$		0.029	0.040	$\Omega$
		$V_{GS} = -4.5 \text{ V}, I_D = -3.4 \text{ A}$		0.047	0.070	
Forward Transconductance <sup>a</sup>	$g_{fs}$	$V_{DS} = -15 \text{ V}, I_D = -4.5 \text{ A}$		9.3		S
Diode Forward Voltage <sup>a</sup>	$V_{SD}$	$I_S = -1.25 \text{ A}, V_{GS} = 0 \text{ V}$		-0.8	-1.2	V
<b>Dynamic<sup>b</sup></b>						
Total Gate Charge	$Q_g$	$V_{DS} = -15 \text{ V}, V_{GS} = -10 \text{ V}, I_D = -4.5 \text{ A}$		25	35	nC
Gate-Source Charge	$Q_{gs}$			5.0		
Gate-Drain Charge	$Q_{gd}$			4.0		
Turn-On Delay Time	$t_{d(on)}$	$V_{DD} = -15 \text{ V}, R_L = 15 \Omega$ $I_D \cong -1 \text{ A}, V_{GEN} = -10 \text{ V}, R_G = 6 \Omega$		12	20	ns
Rise Time	$t_r$			13	20	
Turn-Off Delay Time	$t_{d(off)}$			40	55	
Fall Time	$t_f$			16	25	
Source-Drain Reverse Recovery Time	$t_{rr}$	$I_F = -1.25 \text{ A}, di/dt = 100 \text{ A}/\mu\text{s}$		50	80	

### Notes

- a. Pulse test; pulse width  $\leq 300 \mu\text{s}$ , duty cycle  $\leq 2\%$ .  
b. Guaranteed by design, not subject to production testing.

## Typical Characteristics (25°C Unless Noted)

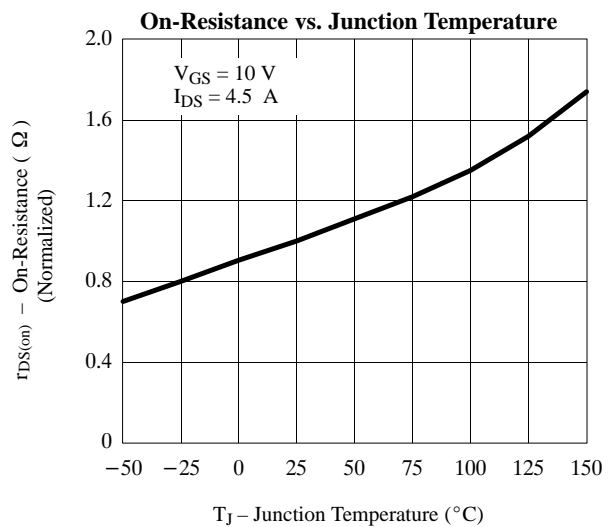
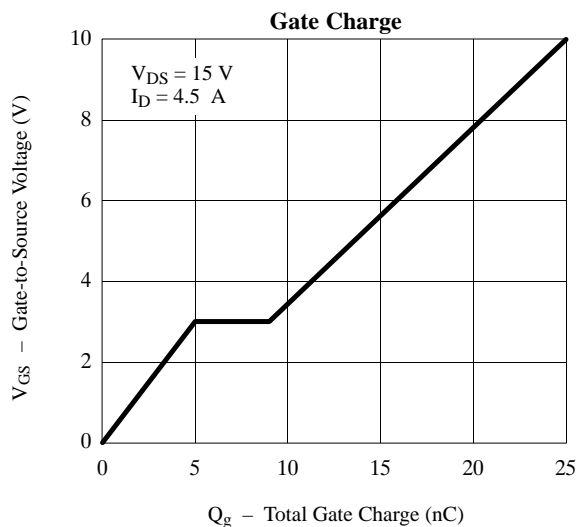
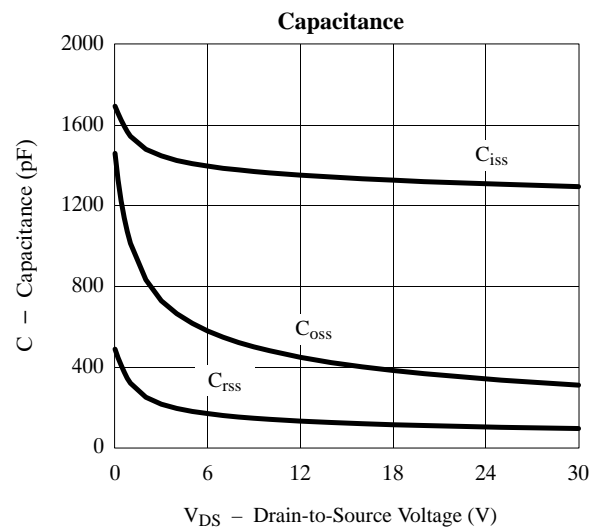
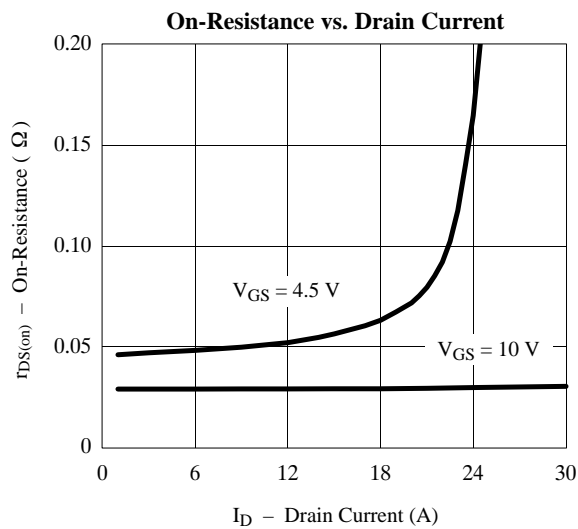
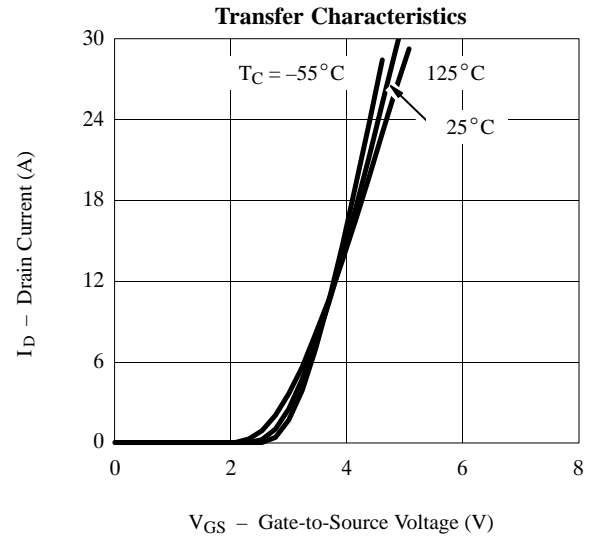
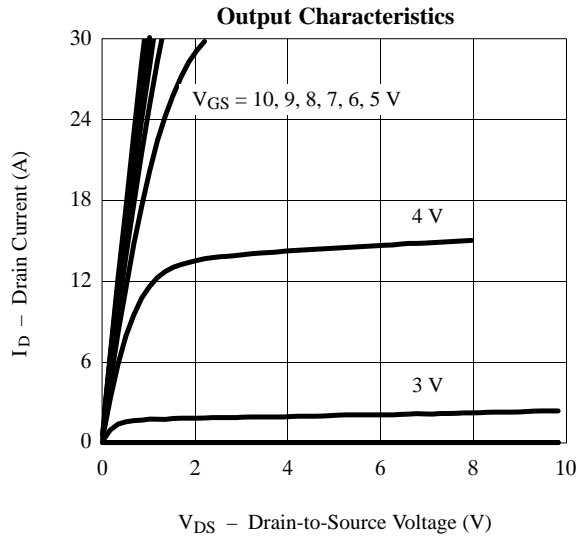

## Typical Characteristics (25°C Unless Noted)

