

RF & MICROWAVE TRANSISTORS HF SSB APPLICATIONS

- OPTIMIZED FOR SSB
- 30 MHz
- 50 VOLTS
- IMD -30 dB
- COMMON EMITTER
- GOLD METALLIZATION
- P_{OUT} = 150 W PEP MIN. WITH 14 dB GAIN

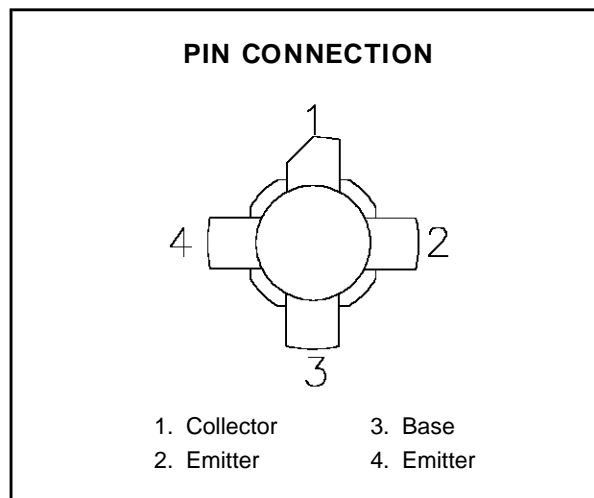
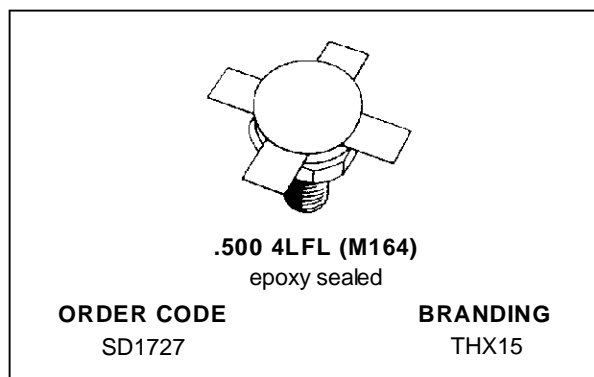

DESCRIPTION

The SD1727 is a 50 V epitaxial silicon NPN planar transistor designed primarily for SSB communications. This device utilizes emitter ballasting to achieve extreme ruggedness under severe operating conditions.

ABSOLUTE MAXIMUM RATINGS (T_{case} = 25°C)

Symbol	Parameter	Value	Unit
V _{CBO}	Collector-Base Voltage	110	V
V _{CEO}	Collector-Emitter Voltage	55	V
V _{EBO}	Emitter-Base Voltage	4.0	V
I _C	Device Current	10	A
P _{DISS}	Power Dissipation	233	W
T _J	Junction Temperature	+200	°C
T _{STG}	Storage Temperature	- 65 to +150	°C

THERMAL DATA

R _{TH(j-c)}	Junction-Case Thermal Resistance	0.75	°C/W
----------------------	----------------------------------	------	------

SD1727 (THX15)

ELECTRICAL SPECIFICATIONS ($T_{case} = 25^{\circ}C$)

STATIC

Symbol	Test Conditions		Value			Unit
			Min.	Typ.	Max.	
BV_{CBO}	$I_C = 100mA$	$I_E = 0mA$	110	—	—	V
BV_{CES}	$I_C = 100mA$	$V_{BE} = 0V$	110	—	—	V
BV_{CEO}	$I_C = 100mA$	$I_B = 0mA$	55	—	—	V
BV_{EBO}	$I_E = 10mA$	$I_C = 0mA$	4.0	—	—	V
I_{CEO}	$V_{CE} = 30V$	$I_E = 0mA$	—	—	5	mA
I_{CES}	$V_{CE} = 60V$	$I_E = 0mA$	—	—	5	mA
h_{FE}	$V_{CE} = 6V$	$I_C = 1.4A$	18	—	43.5	—

DYNAMIC

Symbol	Test Conditions			Value			Unit
				Min.	Typ.	Max.	
P_{OUT}	$f = 30\text{ MHz}$	$V_{CE} = 50\text{ V}$	$I_{CQ} = 100mA$	150	—	—	W
G_P^*	$P_{OUT} = 150\text{ W PEP}$	$V_{CE} = 50\text{ V}$	$I_{CQ} = 100mA$	14	—	—	dB
IMD*	$P_{OUT} = 150\text{ W PEP}$	$V_{CE} = 50\text{ V}$	$I_{CQ} = 100mA$	—	—	-30	dBc
η_c^*	$P_{OUT} = 150\text{ W PEP}$	$V_{CE} = 50\text{ V}$	$I_{CQ} = 100mA$	37	—	—	%
C_{OB}	$f = 1\text{ MHz}$	$V_{CB} = 50\text{ V}$		—	—	220	pF

Note: The SD1727 is also usable in Class A at 40 V. Typical performance is:

$P_{OUT} = 30\text{ W PEP}$, $G_P = 14\text{ dB}$, $IMD = -40\text{ dBc}$

* $f_1 = 30.00\text{ MHz}$; $f_2 = 30.001\text{ MHz}$

TYPICAL PERFORMANCE

INTERMODULATION DISTORTION vs POWER OUTPUT PEP

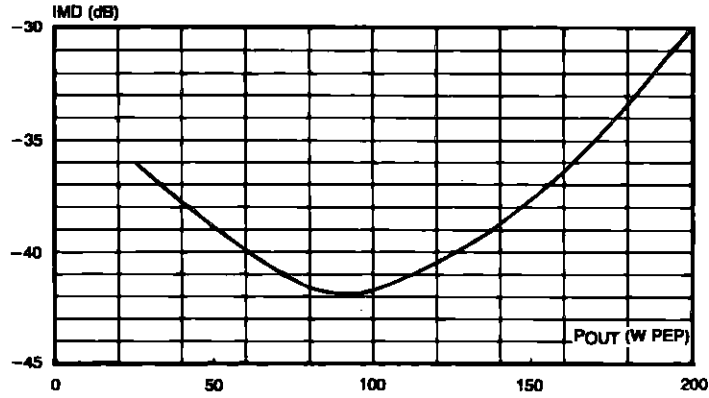

POWER OUTPUT PEP vs POWER INPUT

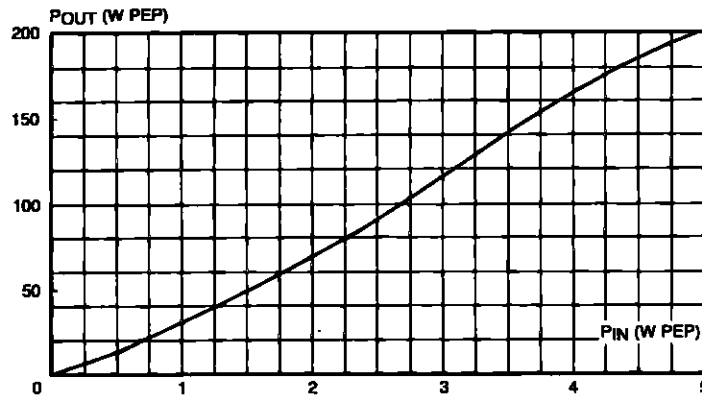

COLLECTOR EFFICIENCY vs POWER OUTPUT PEP

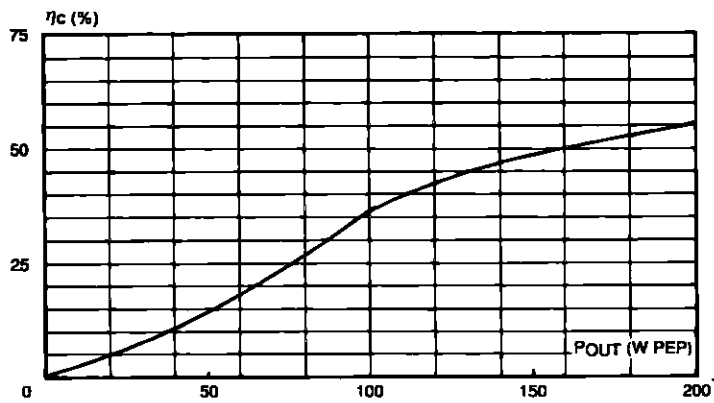

TYPICAL PERFORMANCE (cont'd)

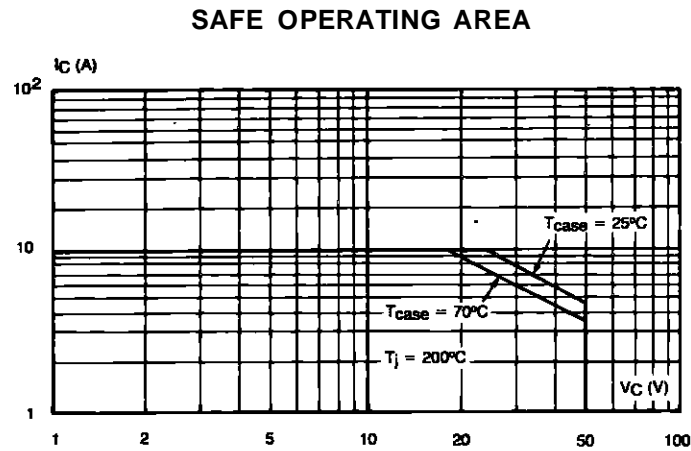
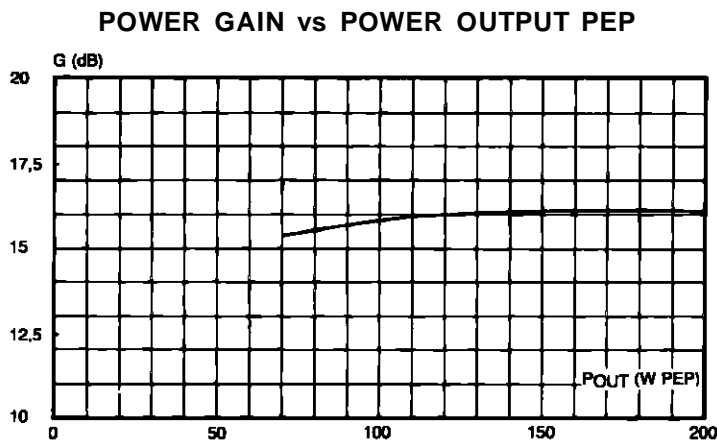
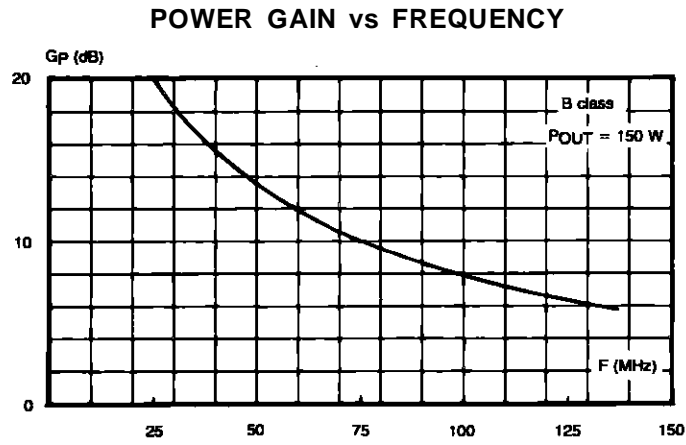

IMPEDANCE DATA

TYPICAL INPUT IMPEDANCE

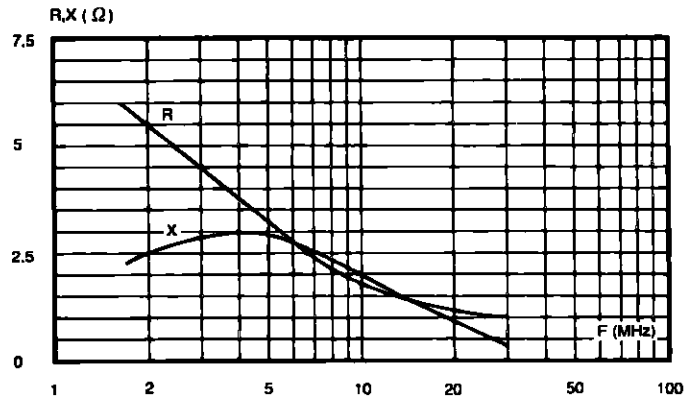

BIAS CIRCUIT

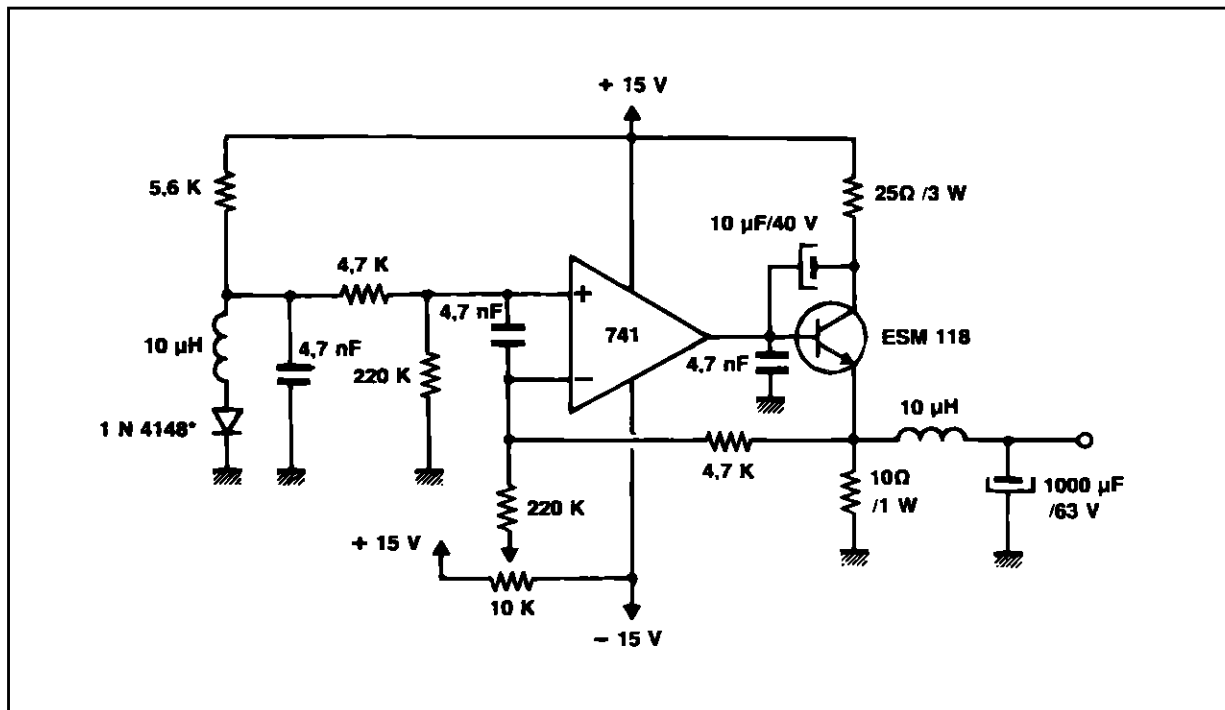

SD1727 (THX15)

TEST CIRCUIT - CLASS AB - 30 MHz

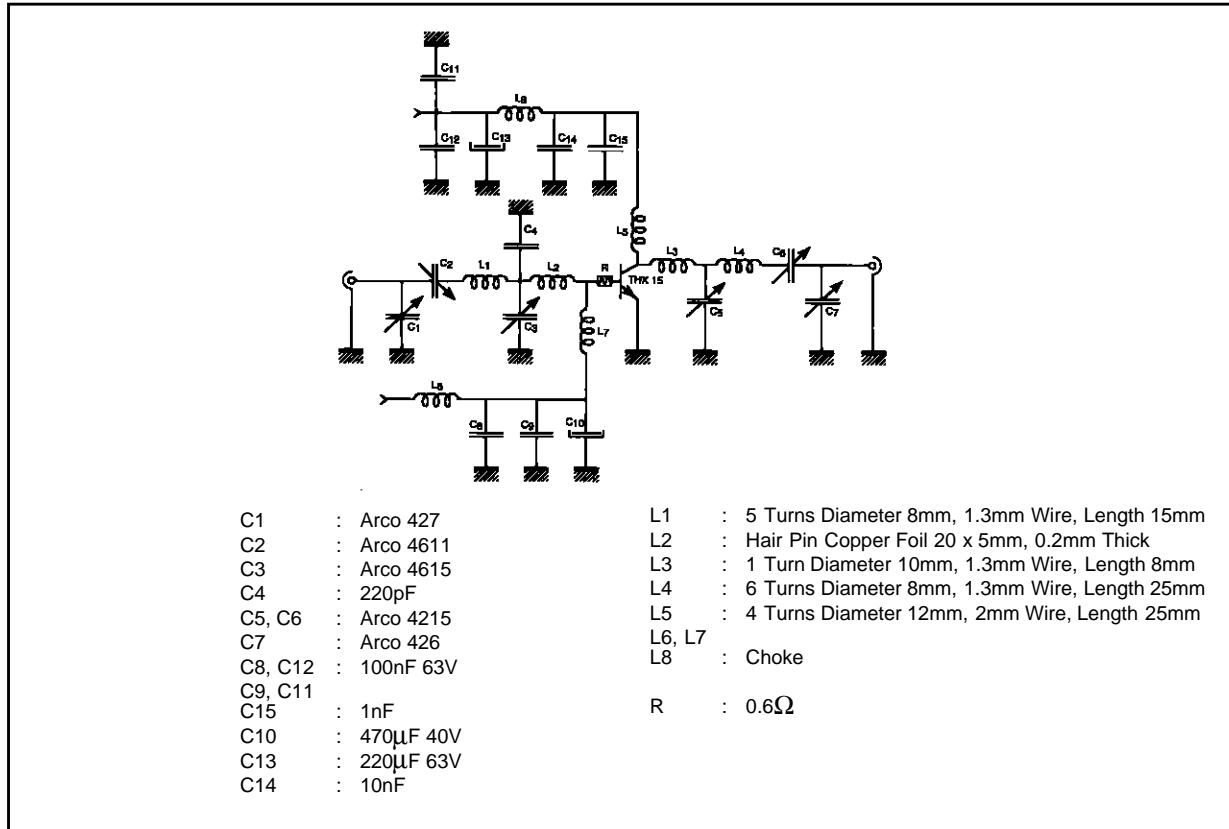

MOUNTING CIRCUIT - CLASS AB - 30MHz

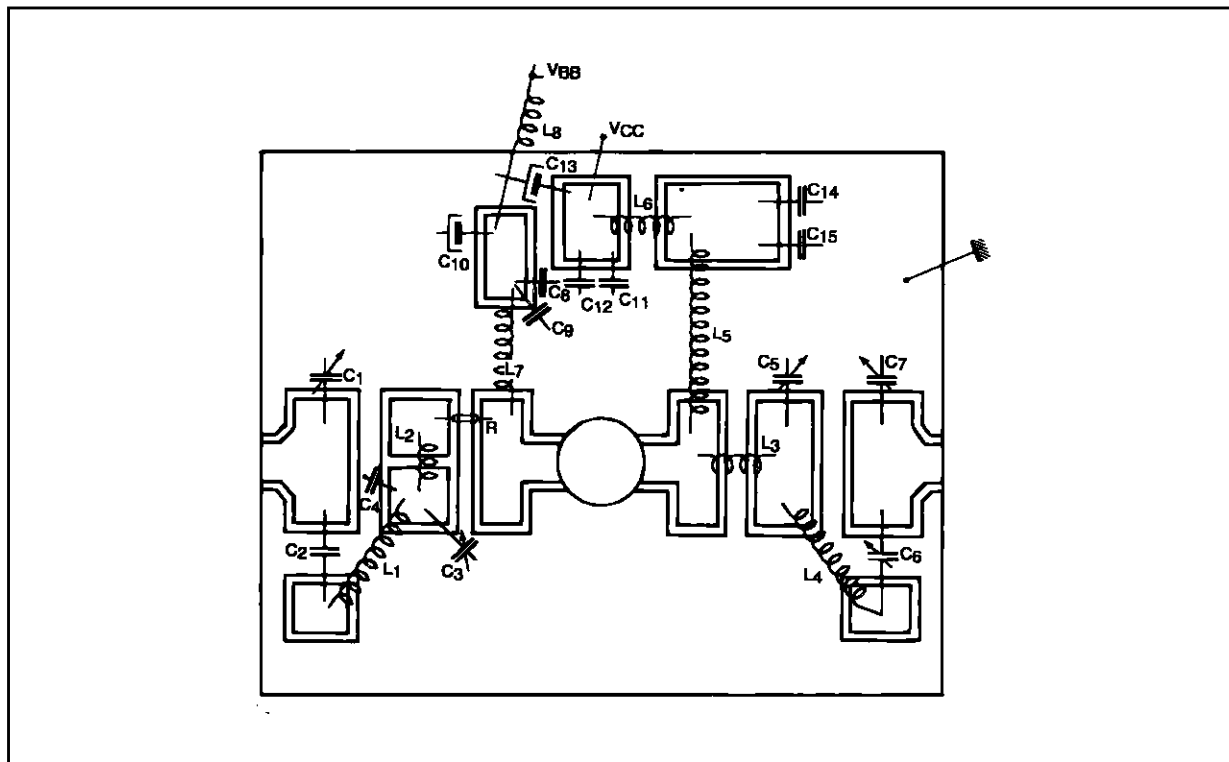

PACKAGE MECHANICAL DATA

Ref.: Dwg. No.12-0164

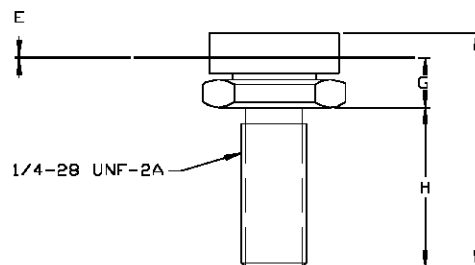
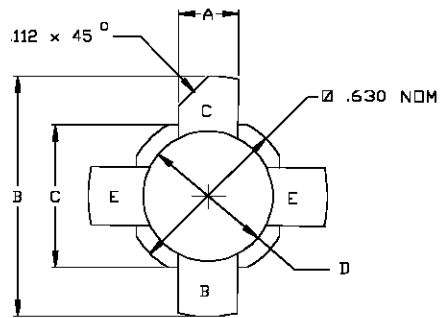

SGS-THOMSON MICROELECTRONICS		
	MINIMUM Inches/mm	MAXIMUM Inches/mm
A	.220/5,59	.230/5,84
B		1.050/26,67
C	.545/13,84	.555/14,10
D	.495/12,57	.505/12,83
E	.003/0,08	.007/0,18
F		.830/21,08
G	.185/4,70	.198/5,03
H	.497/12,62	.530/13,46

Information furnished is believed to be accurate and reliable. However, SGS-THOMSON Microelectronics assumes no responsibility for the consequences of use of such information nor for any infringement of patents or other rights of third parties which may result from its use. No license is granted by implication or otherwise under any patent or patent rights of SGS-THOMSON Microelectronics. Specifications mentioned in this publication are subject to change without notice. This publication supersedes and replaces all information previously supplied. SGS-THOMSON Microelectronics products are not authorized for use as critical components in life support devices or systems without express written approval of SGS-THOMSON Microelectronics.

© 1994 SGS-THOMSON Microelectronics - All Rights Reserved

SGS-THOMSON Microelectronics GROUP OF COMPANIES
 Australia - Brazil - France - Germany - Hong Kong - Italy - Japan - Korea - Malaysia - Malta - Morocco - The Netherlands -
 Singapore - Spain - Sweden - Switzerland - Taiwan - Thailand - United Kingdom - U.S.A