

DATA SHEET

PMBF4416; PMBF4416A N-channel field-effect transistor

Product specification
File under Discrete Semiconductors, SC07

April 1995

N-channel field-effect transistor

PMBF4416; PMBF4416A

FEATURES

- Low noise
- Interchangeability of drain and source connections
- High gain.

DESCRIPTION

N-channel symmetrical silicon junction FETs in a surface-mountable SOT23 envelope. These devices are intended for use in VHF/UHF amplifiers, oscillators and mixers.

PINNING - SOT23

PIN	DESCRIPTION
1	source
2	drain
3	gate

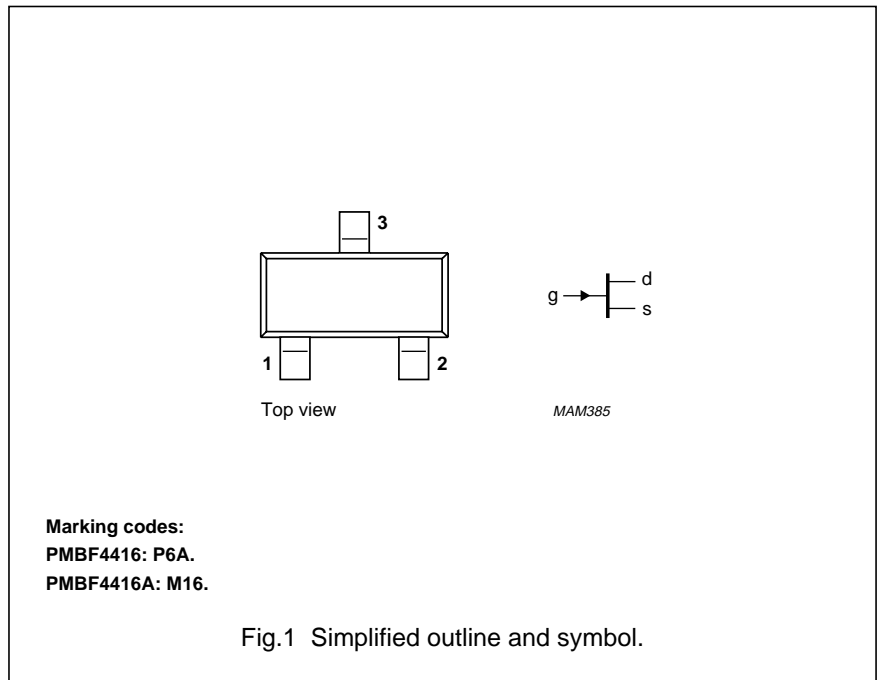

QUICK REFERENCE DATA

SYMBOL	PARAMETER	CONDITIONS	MIN.	MAX.	UNIT
V_{DS}	drain-source voltage		–	30	V
	PMBF4416		–	35	V
I_{DSS}	drain-source current	$V_{DS} = 15\text{ V};$ $V_{GS} = 0$	5	15	mA
	PMBF4416A				
P_{tot}	total power dissipation	up to $T_{amb} = 25\text{ °C}$	–	250	mW
$V_{GS(off)}$	gate-source cut-off voltage	$V_{DS} = 15\text{ V};$ $I_D = 1\text{ nA}$	–	–6	V
	PMBF4416		–2.5	–6	V
$ Y_{fs} $	common-source transfer admittance	$V_{DS} = 15\text{ V};$ $V_{GS} = 0; f = 1\text{ kHz}$	4.5	7.5	mS
	PMBF4416A				

N-channel field-effect transistor

PMBF4416; PMBF4416A

LIMITING VALUES

In accordance with the Absolute Maximum Rating System (IEC 134).

SYMBOL	PARAMETER	CONDITIONS	MIN.	MAX.	UNIT
V_{DS}	drain-source voltage				
	PMBF4416		–	30	V
	PMBF4416A		–	35	V
V_{GSO}	gate-source voltage				
	PMBF4416		–	–30	V
	PMBF4416A		–	–35	V
V_{GDO}	gate-drain voltage				
	PMBF4416		–	–30	V
	PMBF4416A		–	–35	V
I_G	DC forward gate current		–	10	mA
P_{tot}	total power dissipation	up to $T_{amb} = 25\text{ °C}$ (note 1)	–	250	mW
T_{stg}	storage temperature		–65	+150	°C
T_j	junction temperature		–	150	°C

THERMAL RESISTANCE

SYMBOL	PARAMETER	THERMAL RESISTANCE
$R_{th\ j-a}$	from junction to ambient (note 1)	500 K/W

Note

1. Mounted on an FR4 printed-circuit board.

STATIC CHARACTERISTICS $T_j = 25\text{ °C}$ unless otherwise specified.

SYMBOL	PARAMETER	CONDITIONS	MIN.	MAX.	UNIT
$V_{(BR)GSS}$	gate-source breakdown voltage	$V_{DS} = 0$; $I_G = -1\ \mu\text{A}$			
	PMBF4416		–30	–	V
	PMBF4416A		–35	–	V
I_{GSS}	reverse gate leakage current	$V_{DS} = 0$; $V_{GS} = -15\text{ V}$	–	1	nA
I_{DSS}	drain current	$V_{DS} = 15\text{ V}$; $V_{GS} = 0$	5	15	mA
V_{GSS}	gate-source forward voltage	$V_{DS} = 0$; $I_G = 1\text{ mA}$	–	1	V
$V_{GS(off)}$	gate-source cut-off voltage	$V_{DS} = 15\text{ V}$; $I_D = 1\text{ nA}$			
	PMBF4416		–	–6	V
	PMBF4416A		–2.5	–6	V
$ Y_{fs} $	common source transfer admittance	$V_{DS} = 15\text{ V}$; $V_{GS} = 0$	4.5	7.5	mS
$ Y_{os} $	common source output admittance	$V_{DS} = 15\text{ V}$; $V_{GS} = 0$			
	PMBF4416		–	50	μS
	PMBF4416A		–	50	μS

N-channel field-effect transistor

PMBF4416; PMBF4416A

DYNAMIC CHARACTERISTICS

$T_j = 25\text{ }^\circ\text{C}$; $V_{DS} = 15\text{ V}$; $V_{GS} = 0$.

SYMBOL	PARAMETER	CONDITIONS	MIN.	TYP.	MAX.	UNIT
C_{is}	input capacitance	$f = 1\text{ MHz}$	–	–	4	pF
C_{os}	output capacitance	$f = 1\text{ MHz}$	–	–	2	pF
C_{rs}	feedback capacitance	$f = 1\text{ MHz}$	–	–	0.8	pF
g_{is}	common source input conductance	$f = 100\text{ MHz}$	–	–	100	μS
		$f = 400\text{ MHz}$	–	–	1	mS
g_{fs}	common source transfer conductance	$f = 100\text{ MHz}$	–	5.2	–	mS
		$f = 400\text{ MHz}$	4	5	–	mS
g_{rs}	common source feedback conductance	$f = 100\text{ MHz}$	–	–8	–	μS
		$f = 400\text{ MHz}$	–	–100	–	μS
g_{os}	common source output conductance	$f = 100\text{ MHz}$	–	–	75	μS
		$f = 400\text{ MHz}$	–	–	100	μS
V_n	equivalent input noise voltage	$f = 100\text{ Hz}$	–	5	–	nV/ $\sqrt{\text{Hz}}$

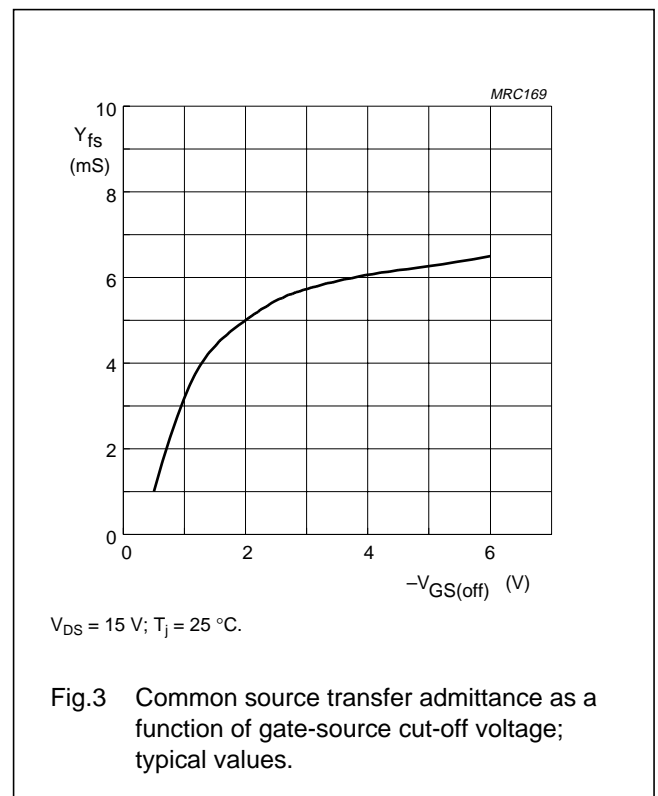
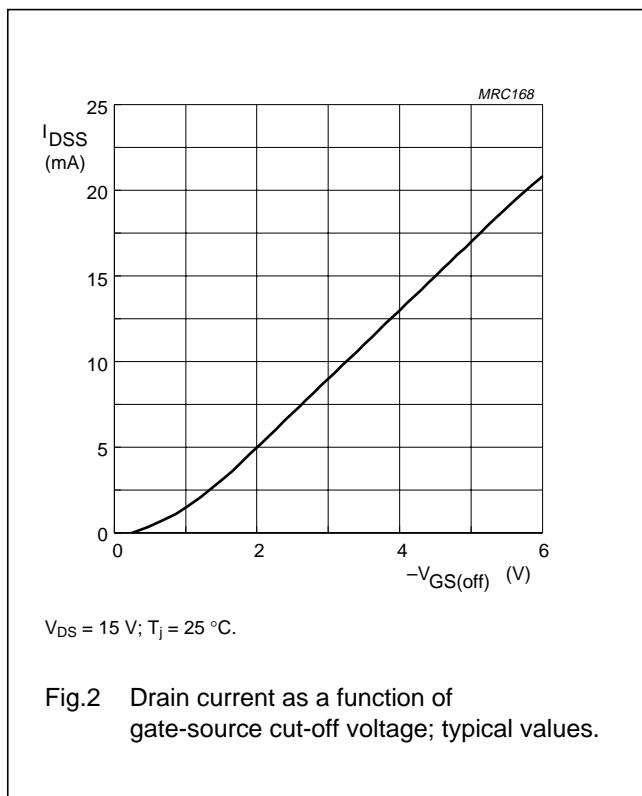

N-channel field-effect transistor

PMBF4416; PMBF4416A

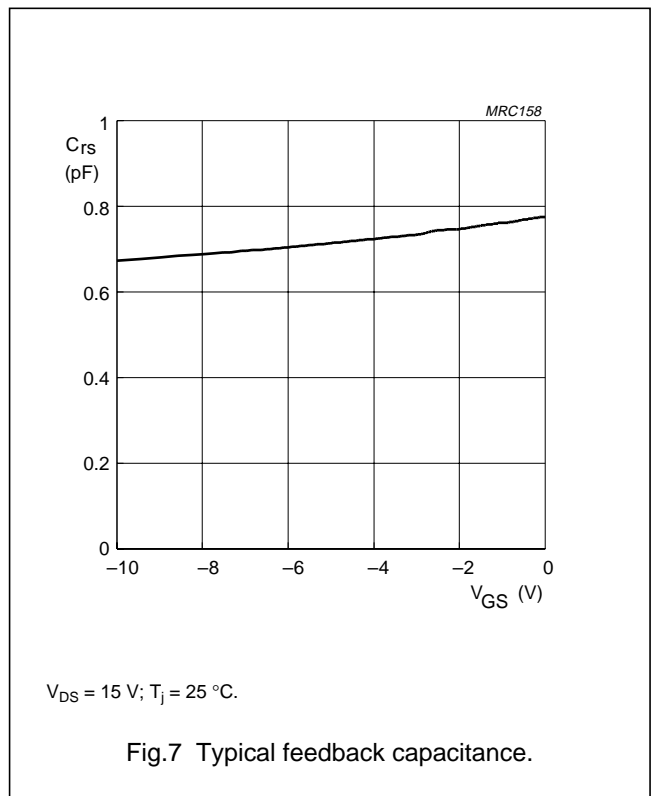
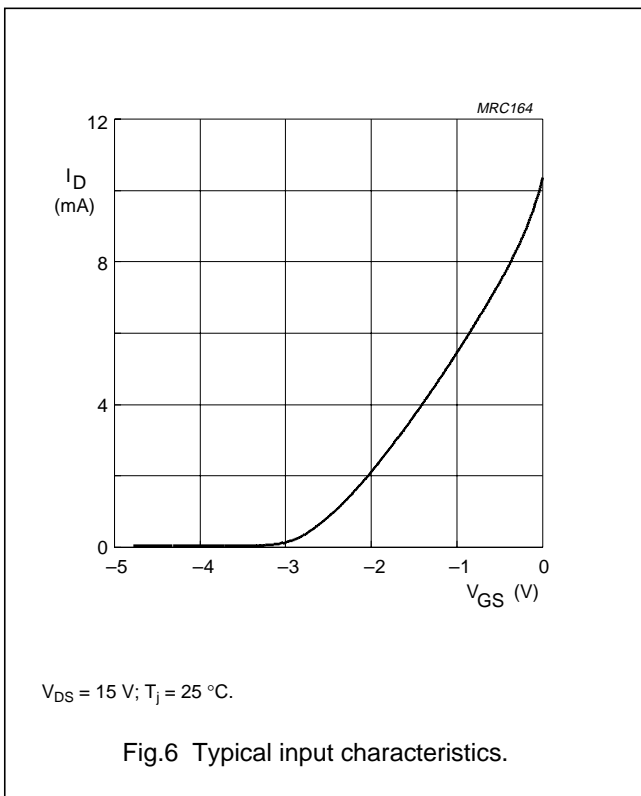
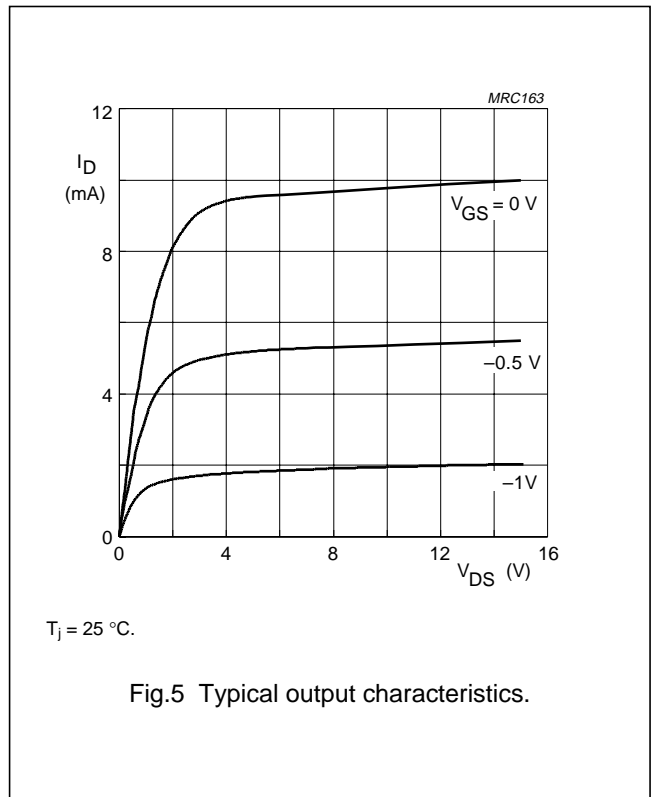
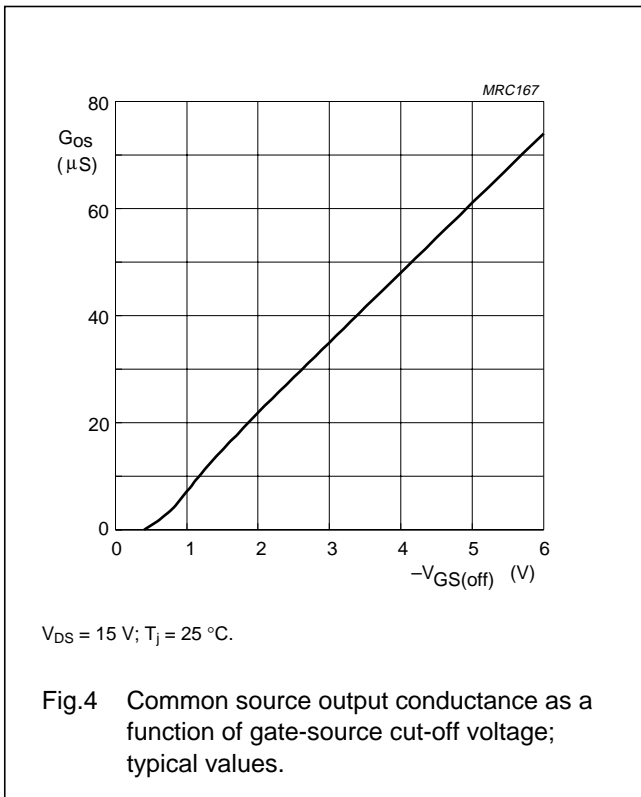

N-channel field-effect transistor

PMBF4416; PMBF4416A

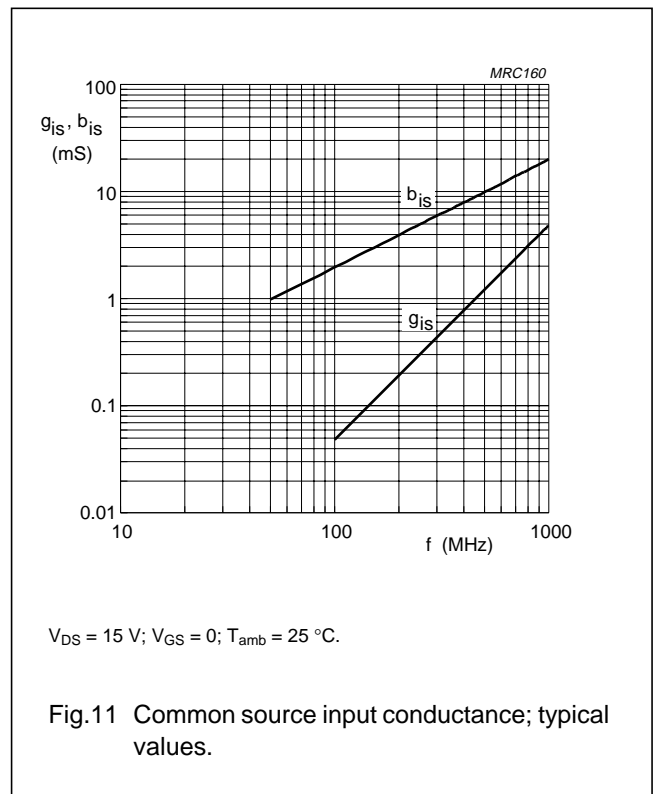
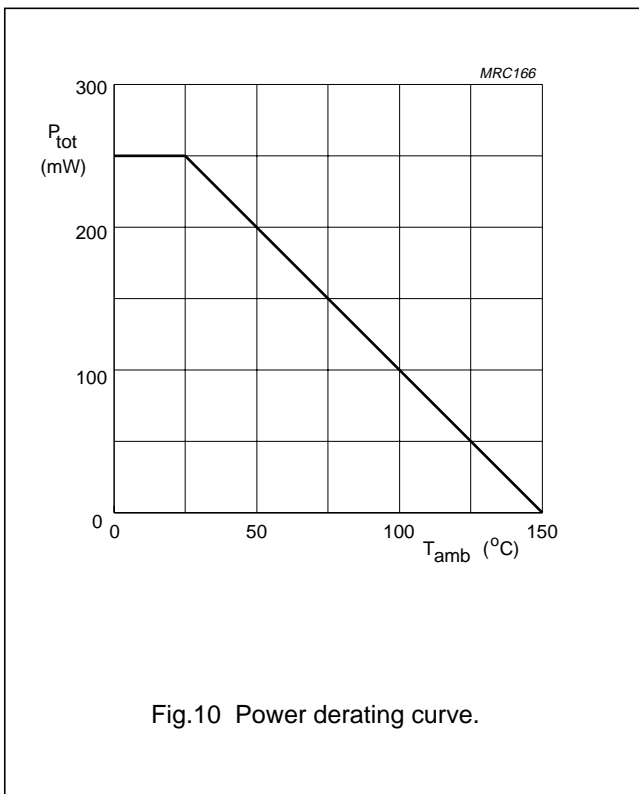
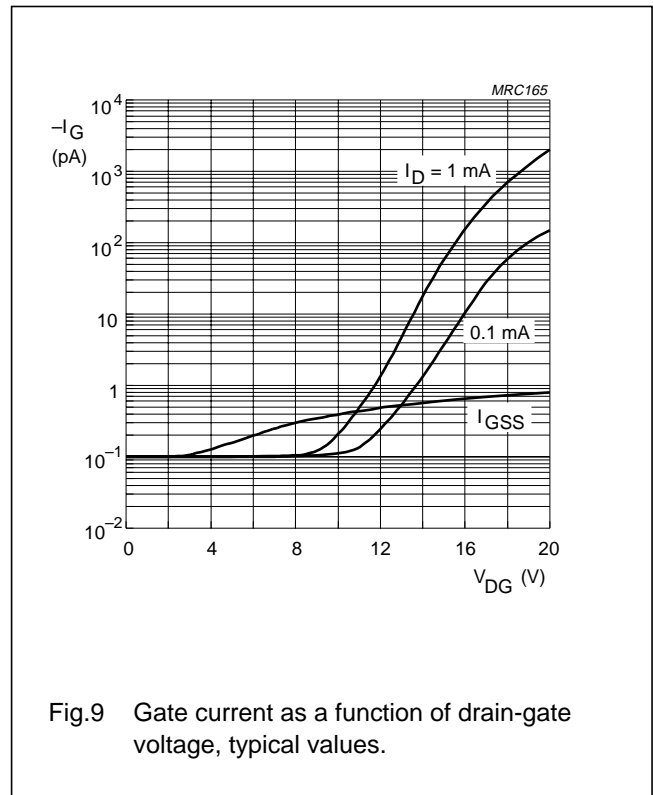
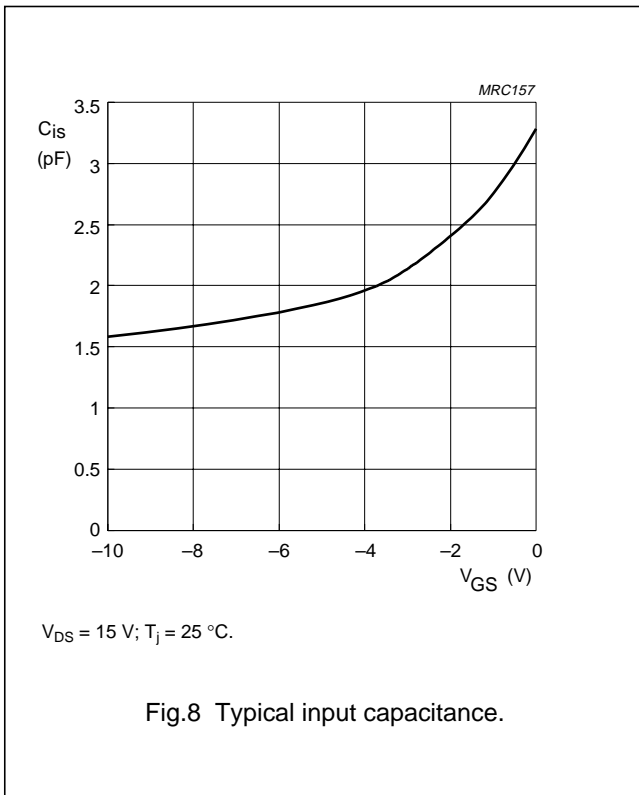

N-channel field-effect transistor

PMBF4416; PMBF4416A

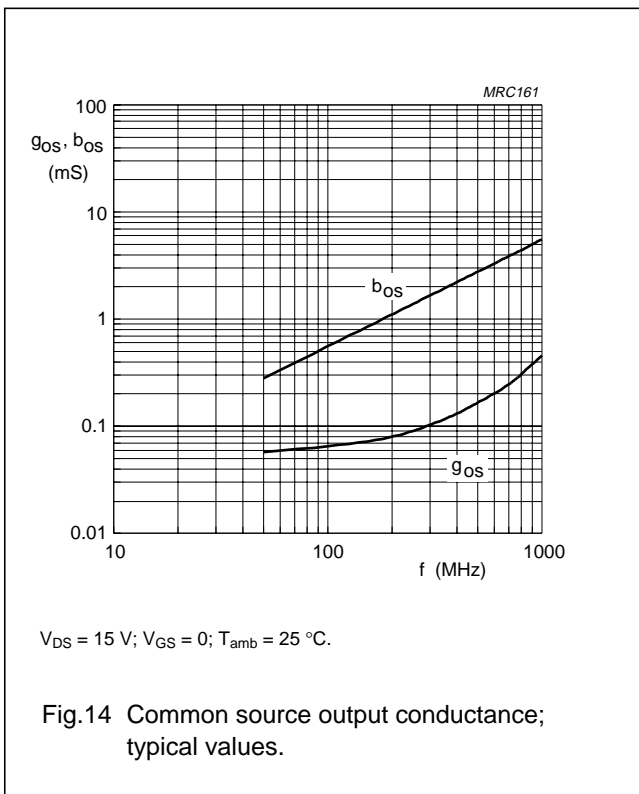
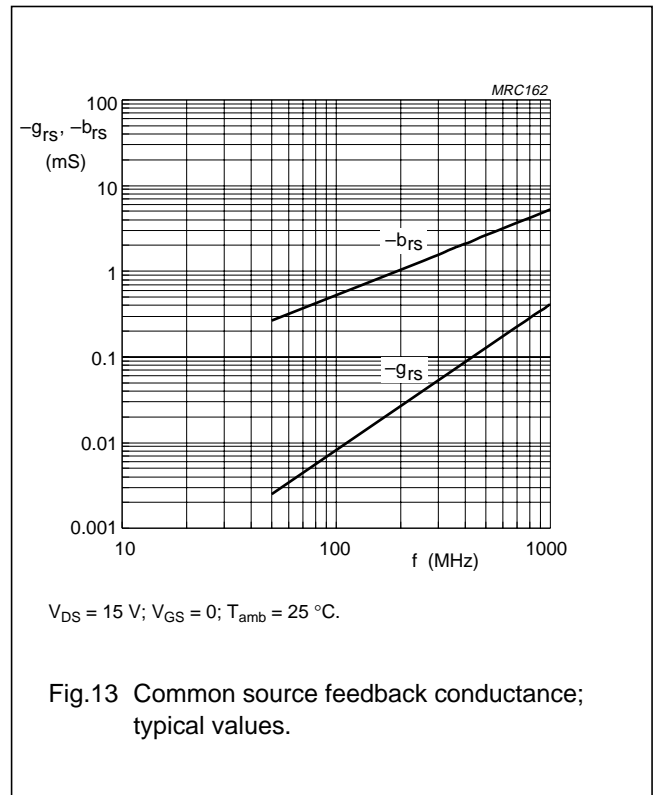
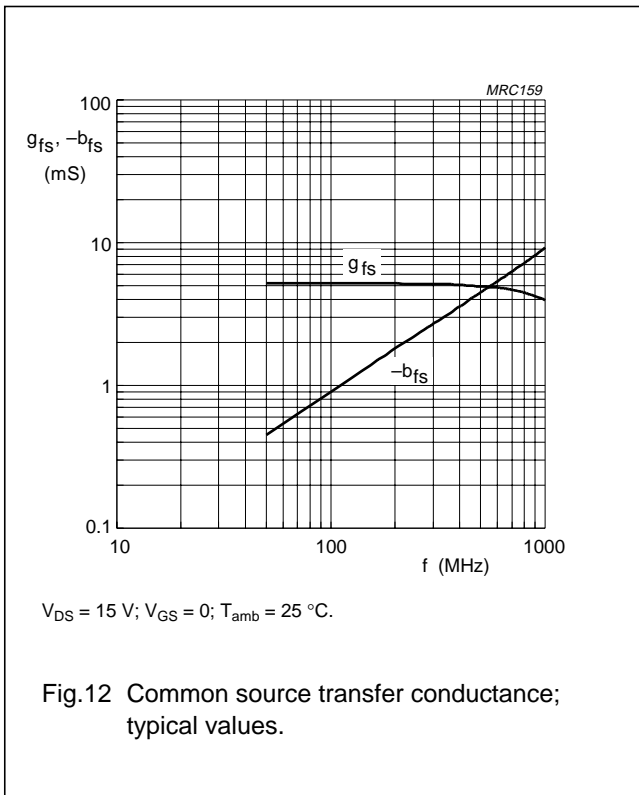

SPICE parameters for PMBF4416

September 1992; version 1.0.

1	VTO = -3.553	V
2	BETA = 792.6	$\mu\text{A}/\text{V}^2$
3	LAMBDA = 18.46	m/V
4	RD = 7.671	Ω
5	RS = 7.671	Ω
6	IS = 333.4	aA
7	CGSO = 2.920	pF
8	CGDO = 2.261	pF
9	PB = 1.090	V
10 (note 1)	FC = 500.0	m

Note

1. Parameter not extracted; default value.

N-channel field-effect transistor

PMBF4416; PMBF4416A

PACKAGE OUTLINE

Plastic surface mounted package; 3 leads

SOT23

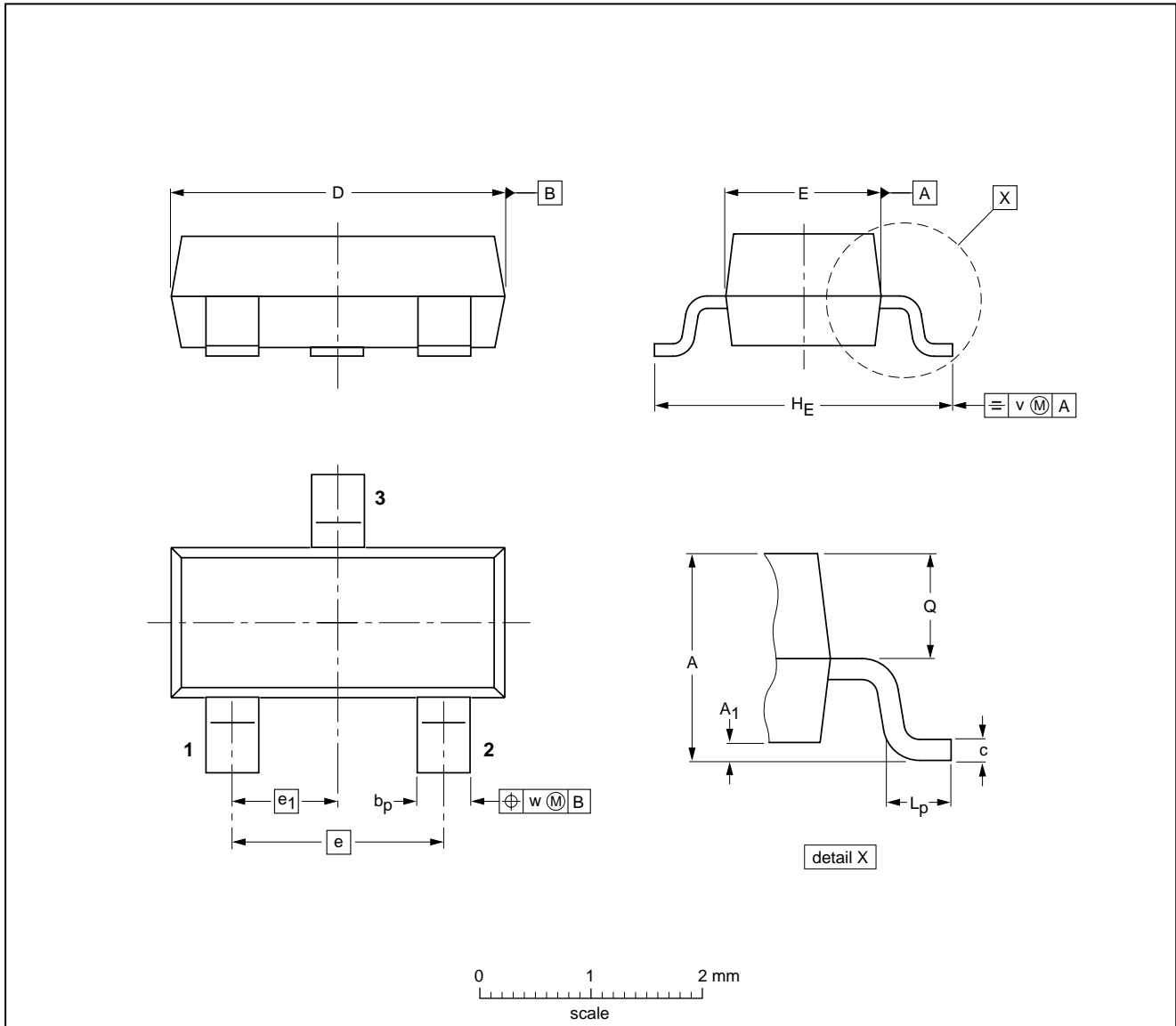

DIMENSIONS (mm are the original dimensions)

UNIT	A	A ₁ max.	b _p	c	D	E	e	e ₁	H _E	L _p	Q	v	w
mm	1.1 0.9	0.1	0.48 0.38	0.15 0.09	3.0 2.8	1.4 1.2	1.9	0.95	2.5 2.1	0.45 0.15	0.55 0.45	0.2	0.1

OUTLINE VERSION	REFERENCES				EUROPEAN PROJECTION	ISSUE DATE
	IEC	JEDEC	EIAJ			
SOT23						97-02-28

N-channel field-effect transistor

PMBF4416; PMBF4416A

DEFINITIONS

Data sheet status	
Objective specification	This data sheet contains target or goal specifications for product development.
Preliminary specification	This data sheet contains preliminary data; supplementary data may be published later.
Product specification	This data sheet contains final product specifications.
Short-form specification	The data in this specification is extracted from a full data sheet with the same type number and title. For detailed information see the relevant data sheet or data handbook.
Limiting values	
Limiting values given are in accordance with the Absolute Maximum Rating System (IEC 134). Stress above one or more of the limiting values may cause permanent damage to the device. These are stress ratings only and operation of the device at these or at any other conditions above those given in the Characteristics sections of the specification is not implied. Exposure to limiting values for extended periods may affect device reliability.	
Application information	
Where application information is given, it is advisory and does not form part of the specification.	

LIFE SUPPORT APPLICATIONS

These products are not designed for use in life support appliances, devices, or systems where malfunction of these products can reasonably be expected to result in personal injury. Philips customers using or selling these products for use in such applications do so at their own risk and agree to fully indemnify Philips for any damages resulting from such improper use or sale.