

# 16 × 32 Dot Matrix Unit

## LUM-5125MU300

The LUM-5125MU300 is a 16 × 32 dot matrix display which can be used in a wide range of applications, including alphabet, numeric, symbol and graphical displays. A large display can be easily created by arranging a number of these dot matrix displays in an array, and they can be applied to a variety of display purposes. A custom LSI controller has display data memory for two screens, and data for each screen can be written and displayed in turn.

●Application

Light source for displays

●Features

- 1) 16 × 32 dot matrix  
Circular emitters 5 mm in diameter.
- 2) Dimensions : 96 mm × 192 mm
- 3) Clear display.
- 4) Three-color display is possible (red, green, and orange).
- 5) 1/16 Duty Dynamic Scan method.

●Specifications

For detailed specifications, refer to pages 278 to 286.

●External dimensions (Unit: mm)

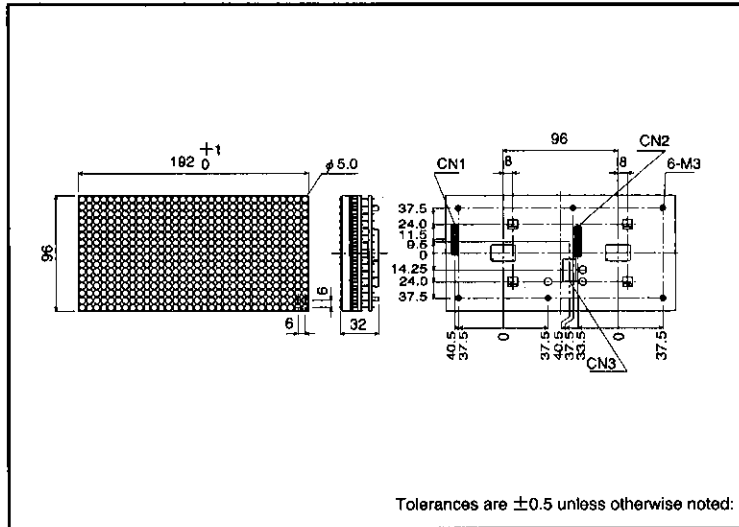











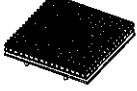

●Selection guide

Display Type	Reflection Lamp
Type	LUM-5125MU300

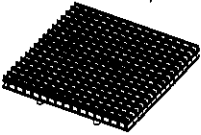
LUM Unit Series

●LUM dot matrix series table

		Cylindrical LED type	Reflection LED type	High-luminance type	1/8duty high-luminance type
Type	16×16	LUM-2563MU301	LUM-2563MU302	LUM-2563ML304	
Dot Size	φ 3				_____
Dimensions	64×64mm				
Type	16×16	LUM-2565MU309	LUM-2565MU304		LUM-2565ML304 (Reflective case with louver)
Dot Size	φ 5			_____	
Dimensions	96×96mm				
Type	16×16		LUM-2568MU302	LUM-2568ML302 (Reflective case with louver)	LUM-2568ML303 (Reflective case with louver)
Dot Size	φ 8	_____			
Dimensions	144×144mm				
Type	16×16				LUM-2568ML353 (Reflective case with louver)
Dot Size	φ 8	_____	_____	_____	
Dimensions	200×200mm				

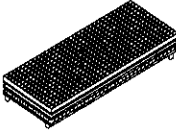
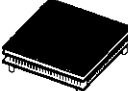
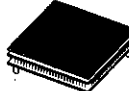
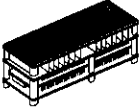
		COB display type	Cylindrical LED type	Reflection LED type	High-luminance type
Type	16×32	LUM-5122MU302			
Dot Size	φ 2		_____	_____	_____
Dimensions	40×80mm				
Type	16×32		LUM-5123MU300	LUM-5123MU301	
Dot Size	φ 3	_____			_____
Dimensions	64×128mm				
Type	16×32			LUM-5125MU300	
Dot Size	φ 5	_____	_____		_____
Dimensions	96×192mm				
Type	24×24			LUM-5763MU302	LUM-5763ML300
Dot Size	φ 3	_____	_____		
Dimensions	96×96mm				
Type	24×48	LUM-1151MU301			
Dot Size	φ 1.6		_____	_____	_____
Dimensions	48×96mm				

● Main specifications

Size	Display Type	Type	Emitting color	Emitting material	Peak Wave-length (nm)	Dot Dia (mm)	Dot Pitch (mm)	Number of Dot (dot)	Control Circuit		Display Circuit		Lumi-nance Typ. (cd/m <sup>2</sup> )	Opera-tion Freq-ency Max. (MHz)	Driving System
									V <sub>DD</sub> (V)	I <sub>OC1</sub> Max. (mA)	V <sub>LED</sub> (V)	I <sub>OC2</sub> Max. (A)			
□40 X2	COB	LUM-5122MU302	Red	GaAsP	635	φ 2	2.5	16 X 32	5	100	5	2.2	140	20	1/16 Duty Dynamic lighting up
			Green	Gap	563										
□48 X2	COB	LUM-1151MU301	Red	GaAsP	635	φ 1.6	2	24 X 48	5	50	5	3.5	150	20	1/24 Duty Dynamic lighting up
			Green	Gap	563										
□64	Cylindrical Lamp Used Type Milky white	LUM-2563MU301	Red	GaAsP	635	φ 3.0	4	16 X 16	5	50	5	2.8	200	20	1/16 Duty Dynamic lighting up
			Green	Gap	563										
	Reflection Lamp Used Type Milky white	LUM-2563MU302	Red	GaAsP	635										
			Green	Gap	563										
Reflection Lamp Used Type Milky White	LUM-2563ML304	Ultra Red	GaAlAs	660	700	Green	Gap	563							
		Green	Gap	563											
□64 X2	Cylindrical Lamp Used Type Milky white	LUM-5123MU300	Red	GaAsP	635	φ 3.0	4	16 X 32	5	100	5	5.6	200	20	1/16 Duty Dynamic lighting up
			Green	Gap	563										
	Reflection Lamp Used Type Milky white	LUM-5123MU301	Red	GaAsP	635										
			Green	Gap	563										
□96	Cylindrical Lamp Used Type Milky white	LUM-2565MU309	Red	GaAsP	635	φ 5.0	6	16 X 16	5	50	5	2.8	140	20	1/16 Duty Dynamic lighting up
			Green	Gap	563										
	Reflection Lamp Used Type Milky white	LUM-2565MU304	Red	GaAsP	635										
			Green	Gap	563										
Reflection Lamp Used Type	LUM-2565ML304	Ultra Red	GaAlAs	660	1300	Green	Gap	563							
		Green	Gap	563											
□96 X2	Reflection Lamp Used Type Milky white	LUM-5125MU300	Red	GaAsP	635	φ 5.0	6	16 X 32	5	100	5	5.6	500	20	1/16 Duty Dynamic lighting up
			Green	Gap	563										
□96	Reflection Lamp Used Type Milky white	LUM-5763MU302	Red	GaAsP	635	φ 3.0	4	24 X 24	5	50	5	3.2	200	20	1/24 Duty Dynamic lighting up
			Green	Gap	563										
	Reflection Lamp Used Type Milky white	LUM-5763ML300	Ultra Red	GaAlAs	660										
			Green	Gap	563										
□144	Reflection Lamp Used Type Milky white	LUM-2568MU302	Red	GaAsP	635	φ 7.5	9	16 X 16	5	50	5	2.8	410	20	1/16 Duty Dynamic lighting up
			Green	Gap	563										
	Reflection Lamp Used Type	LUM-2568ML302	Ultra Red	GaAlAs	660										
			Green	Gap	563										
Reflection Lamp Used Type	LUM-2568ML303	Ultra Red	GaAlAs	660	750	Green	Gap	563							
		Green	Gap	563											
□200	Reflection Lamp Used Type	LUM-2568ML353	Ultra Red	GaAlAs	660	φ 7.5	12.5	16 X 16	5	20	5	5.5	400	20	1/8 Duty Dynamic lighting up
			Green	Gap	563										

● Recommended operating conditions

Parameter	Symbol	Min.	Typ.	Max.	Unit
Power supply, control circuit*1		—	5.0	—	V
Power supply, LED's*1	V <sub>LED</sub>	—	5.0	—	V
High level control input voltage*2	V <sub>IH</sub>	4.5	—	5.0	V
Low level control input voltage*2	V <sub>IL</sub>	0	—	1.0	V

\*1 ±5%

\*2 When power voltage for LED's is 5 V.

●Block diagrams

(1) 16 × 16 dot matrix unit

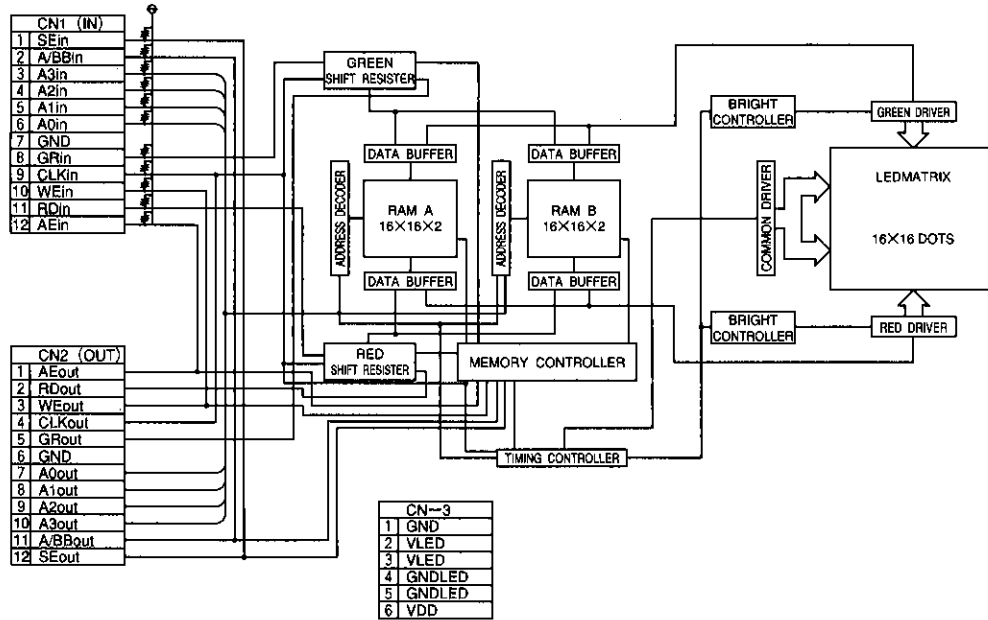

(2) 24 × 24 dot matrix unit

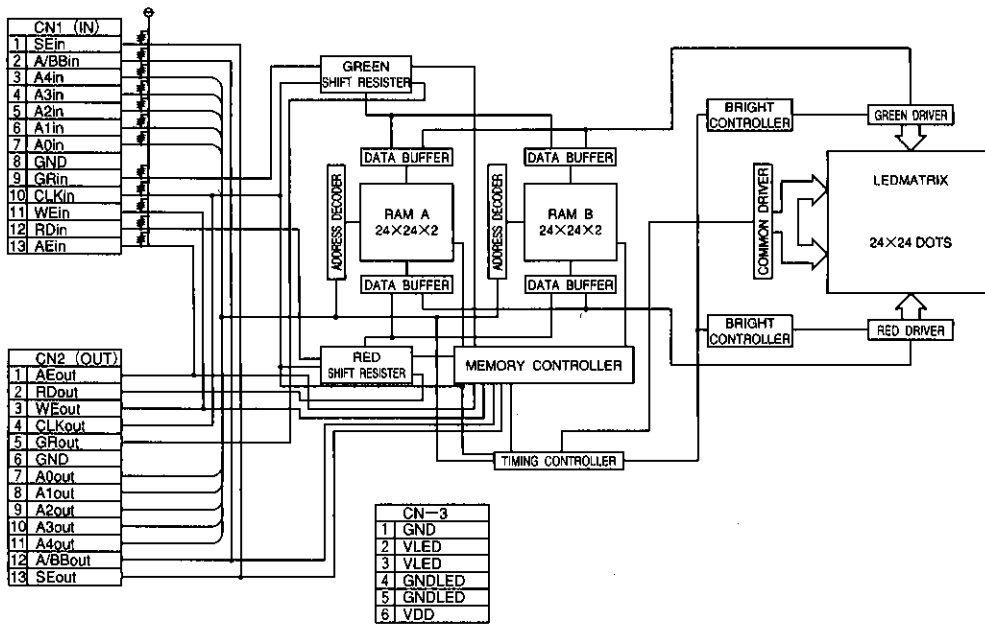

## ● Pin assignments

## (1) CN-1

## • RDin

Data input for red LED. LED is on when this pin is HIGH, and off when it is LOW.

## • GRin

Data input for green LED. LED is on when this pin is HIGH, and off when it is LOW.

## • CLKin

Clock input. Used to load RDin and GRin data (common scan signal). Data is loaded into the internal shift register at the leading edge of the CLK signal.

## • A0in - A3(A4)in

RAM address input. This specifies the address in memory to which display data will be written.

## • WEin

Write control signal. When this signal is HIGH, the contents of the internal shift register are written to memory. (Only valid when AEin is HIGH.)

## • AEin

Address control signal. When this signal is HIGH, the current address in A0in - A3 (A4)in is specified.

## • A/BBin

Control signal for selecting memory where data will be written. When this signal is HIGH, ARAM is selected, and when it is LOW, BRAM is selected.

(Only valid when SEin is HIGH.) The contents of the memory not selected for writing will be displayed.

## • SEin

This signal determines whether memory selection will be made by external control or internal control. When this signal is HIGH, the A/BBin signal determines whether ARAM or BRAM is selected. When ARAM is selected for writing, the BRAM data is displayed, and when BRAM is selected for writing, the ARAM data is displayed.

When this signal is LOW, data will be written to a different memory (from address 0) after the last memory address (15 or 23) is written to. The display data will change simultaneously with the memory change.

## (2) CN-2

## • RDout

Data output for red LED. The signal is output simultaneously with CLK after passing through internal bit shift register 16 (24, 32, 48). If LED modules are connected serially, this pin will be connected to the next module's RDin pin.

## • GRout

Data output for green LED. The signal is output simultaneously with CLK after passing through internal bit shift register 16 (24, 32, 48). If LED modules are connected serially, this pin will be connected to the next module's RDin pin.

## • CLKout

Clock signal output. This pin outputs the CLKin signal. The pin connects to the next module's CLKin pin.

## • A0out - A3 (A4)out

Address signal output. These pins output the signals of A0in - A3 (A4)in. The pins connect to the next module's A0in - A3 (A4)in pins.

## • WEout

WE (write control) signal output. This pin outputs the WEin signal. The pin connects to the next module's WEin pin.

## • AEout

AE (address control) signal output. This pin outputs the AEin signal. The pin connects to the next module's AEin pin.

## • A/BBout

A/BB (selection of memory for writing) signal output. This pin outputs the A/BBout signal. The pin connects to the next module's A/BBin pin.

## • SEout

SE (memory selection control) signal output. This pin outputs the SEin signal. The pin connects to the next module's SEin pin.

## (3) CN-3

## • GND

Control circuit ground.

## • VLED

Supply voltage for LED.

## • GNDLED

LED ground

## • VDD

Supply voltage for control circuit.

● Attention points in handling LED dot matrix units

- (1) Do not drop a dot matrix unit. This may cause deformation of the display or cracks in the solder.
- (2) Be sure to mount the unit in the correct direction. Otherwise, the flow of data will be reversed.

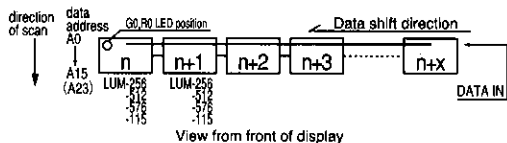

Note: This product may be classified as a strategic good (or function) determined by the foreign exchange and foreign trade laws. Therefore, when exporting this product, be sure to consult ROHM. This product is not designed for resistance against radiation.

- (3) Excessive heat in the unit can cause a drop in luminosity and other operational problems. Use a fan or other means to ensure sufficient heat dissipation.
- (4) The current required for the power supply varies greatly depending on the frequency of turning the LED on. Use a stable power supply which has sufficient capacity to handle sudden changes in load.
- (5) When joining units together to form a panel, design the panel to allow sufficient overall heat dissipation and leave enough clearance for thermal expansion. (As a general guideline, leave a gap of 0.3 mm between units.)
- (6) Do not rub the display surface or use organic solvents such as thinner to clean the display surface.
- (7) These units use high density LSI circuits. Therefore, take sufficient measures to protect them from electrostatic discharge.
- (8) Do not short-circuit the units or apply unnecessarily high voltages to them.
- (9) Do not use the units in conditions where the circuits will be directly exposed to wind and rain.
- (10) If a unit is used at high frequency or if several units are connected together and the signal cable is long, noise may cause malfunctioning. In this case, use a shielded cable and terminate end components.
- (11) As time passes, a difference in luminance may develop between LEDs which illuminate frequently and LEDs which do not. This will be particularly apparent if certain LEDs remain constantly illuminated.
- (12) Ground the control circuit and LED close to the power supply equipment.

## ● Connector signals

(1) 16 × 16 and 16 × 32 dot matrix units

No.	CN-1 signal name
1	SEin
2	A/BBin
3	A3in
4	A2in
5	A1in
6	A0in
7	GND
8	GRin
9	CLKin
10	WEin
11	RDin
12	AEin

No.	CN-2 signal name
1	AEout
2	RDout
3	WEout
4	CLKout
5	GRout
6	GND
7	A0out
8	A1out
9	A2out
10	A3out
11	A/BBout
12	SEout

No.	CN-3 signal name
1	GND
2	VLED
3	VLED
4	GNDLED
5	GNDLED
6	VDD

(2) 24 × 24 and 24 × 48 dot matrix units

No.	CN-1 signal name
1	SEin
2	A/BBin
3	A4in
4	A3in
5	A2in
6	A1in
7	A0in
8	GND
9	GRin
10	CLKin
11	WEin
12	RDin
13	AEin

No.	CN-2 signal name
1	AEout
2	RDout
3	WEout
4	CLKout
5	GRout
6	GND
7	A0out
8	A1out
9	A2out
10	A3out
11	A4out
12	A/BBout
13	SEout

No.	CN-3 signal name
1	GND
2	VLED
3	VLED
4	GNDLED
5	GNDLED
6	VDD



●Timing diagram

(1) 16 × 16 and 16 × 32 dot matrix units

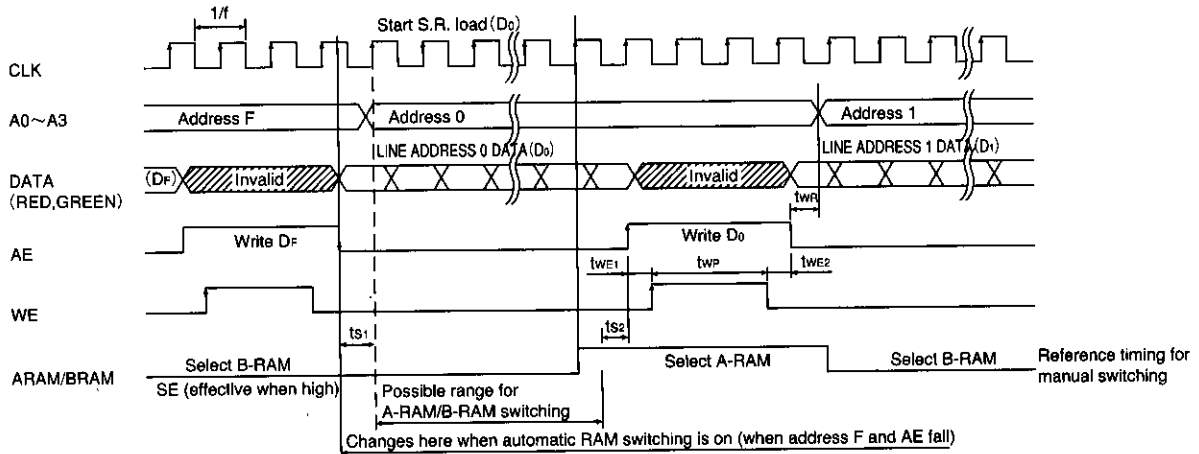

Item	Symbol	Min.	Typ.	Max.	Unit
Clock frequency	f	—	—	20*	MHz
Address hold time	t <sub>WR</sub>	15	—	—	ns
Address enable hold time (1)	t <sub>WE1</sub>	50	—	—	ns
Address enable hold time (2)	t <sub>WE2</sub>	30	—	—	ns
Write pulse time	t <sub>WP</sub>	50	—	—	ns
RAM select time (1)	t <sub>S1</sub>	15	—	—	ns
RAM select time (2)	t <sub>S2</sub>	15	—	—	ns

\* Unit specifications

- 1) When AE is high, the display data is ineffective and the timing of the RAM switching is not related to the display.
- 2) The display data is read when clock rises and is output when the clock rises.
- 3) During the interval while AEin is high, data is not read and the previous data is preserved as the output.
- 4) The switching of the RAM is by A/BB (SEin = H) or by the A0 to A3 addresses changing from 15 to 0.

(2) 24 × 24 and 24 × 48 dot matrix units

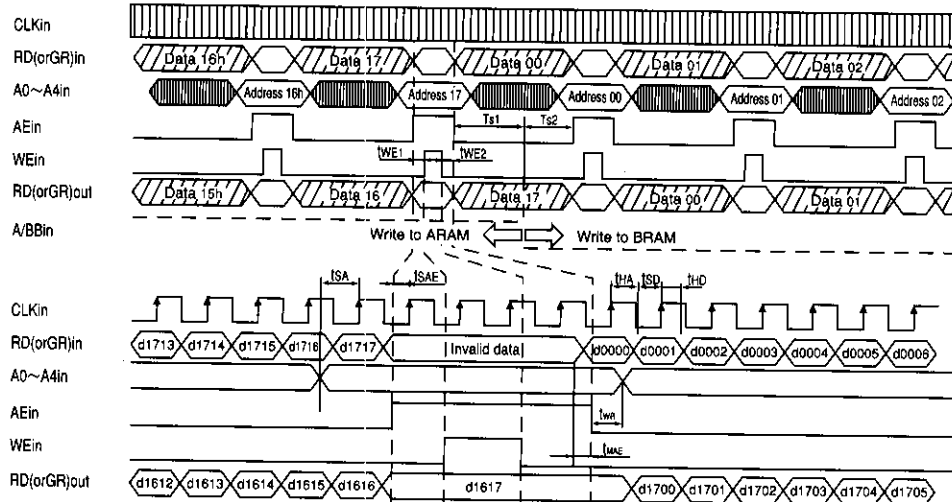

- 1) The display data is read when the clock rises and is output when the clock falls.
- 2) During the interval while AEin is high, data is not read and the previous data is preserved as the output. When AE is high, the display data is ineffective.
- 3) The switching of the RAM is by A/BB (SEin = "H") or by the A0 to A4 addresses changing from 23 to 0.
- 4) The timing of the RAM switching is not related to the display.
- 5) The d17xx in the chart above represents the data of the xx bit of data 17.
- 6) AEin rises while CLKIn is "L".

Item	Symbol	Min.	Typ.	Max.	Unit
Clock frequency	f	—	—	20*	MHz
Address hold time	tWR	15	—	—	ns
Address enable hold time (1)	tWE1	26	—	—	ns
Address enable hold time (2)	tWE2	20	—	—	ns
Write pulse time	tWP	50	—	—	ns
RAM select time (1)	ts1	15	—	—	ns
RAM select time (2)	ts2	15	—	—	ns
Address setup time	tSA	0	—	—	ns
Address hold time	tHA	10	—	—	ns
Data setup time	tSD	10	—	—	ns
Data hold time	tHD	10	—	—	ns
Address enable setup time	tSAE	10	—	—	ns
Address enable hold time	tHAE	0	—	—	ns

\* Unit specifications

## Notes

- The contents described in this catalogue are correct as of March 1997.
- No unauthorized transmission or reproduction of this book, either in whole or in part, is permitted.
- The contents of this book are subject to change without notice. Always verify before use that the contents are the latest specifications. If, by any chance, a defect should arise in the equipment as a result of use without verification of the specifications, ROHM CO., LTD., can bear no responsibility whatsoever.
- Application circuit diagrams and circuit constants contained in this data book are shown as examples of standard use and operation. When designing for mass production, please pay careful attention to peripheral conditions.
- Any and all data, including, but not limited to application circuit diagrams, information, and various data, described in this catalogue are intended only as illustrations of such devices and not as the specifications for such devices. ROHM CO., LTD., disclaims any warranty that any use of such device shall be free from infringement of any third party's intellectual property rights or other proprietary rights, and further, assumes absolutely no liability in the event of any such infringement, or arising from or connected with or related to the use of such devices.
- Upon the sale of any such devices; other than for the buyer's right to use such devices itself, resell or otherwise dispose of the same; no express or implied right or license to practice or commercially exploit any intellectual property rights or other proprietary rights owned or controlled by ROHM CO., LTD., is granted to any such buyer.

The products listed in this catalogue are designed to be used with ordinary electronic equipment or devices (such as audio-visual equipment, office-automation equipment, communications devices, electrical appliances, and electronic toys). Should you intend to use these products with equipment or devices which require an extremely high level of reliability and the malfunction of which would directly endanger human life (such as medical instruments, transportation equipment, aerospace machinery, nuclear-reactor controllers, fuel controllers, or other safety devices) please be sure to consult with our sales representatives in advance.

- **Notes when exporting**

It is essential to obtain export permission when exporting any of the above products when it falls under the category of strategic material (or labor) as determined by foreign exchange or foreign trade control laws. Please be sure to consult with our sales representatives to ascertain whether any product is classified as a strategic material.