

HIGH PERFORMANCE QUAD OPERATIONAL AMPLIFIERS

- SINGLE OR SPLIT SUPPLY OPERATION
- LOW POWER CONSUMPTION
- SHORT CIRCUIT PROTECTION
- LOW DISTORTION, LOW NOISE
- HIGH GAIN-BANDWIDTH PRODUCT
- HIGH CHANNEL SEPARATION

DESCRIPTION

The LS404 is a high performance quad operational amplifier with frequency and phase compensation built into the chip. The internal phase compensation allows stable operation as voltage follower in spite of its high Gain-Bandwidth Product.

The circuit presents very stable electrical characteristics over the entire supply voltage range, and it particularly intended for professional and telecom applications (active filters, etc).

The patented input stage circuit allows small input signal swings below the negative supply voltage and prevents phase inversion when the inputs are over drivers.

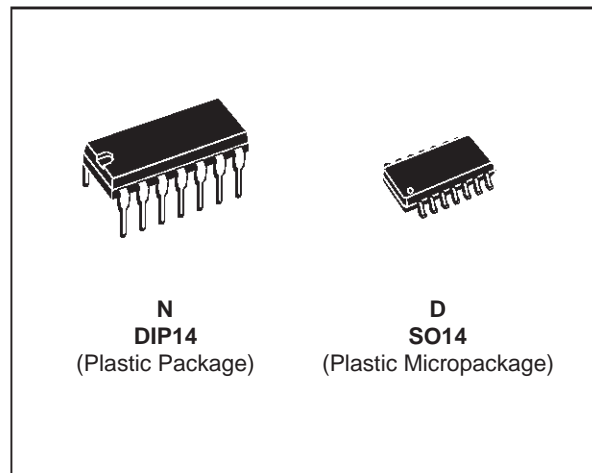

ORDER CODES

Part Number	Temperature Range	Package	
		N	D
LS404C	0°C, +70°C	•	•
LS404I	-40°C, +105°C	•	•
LS404M	-55°C, +125°C	•	•

PIN CONNECTIONS (top view)

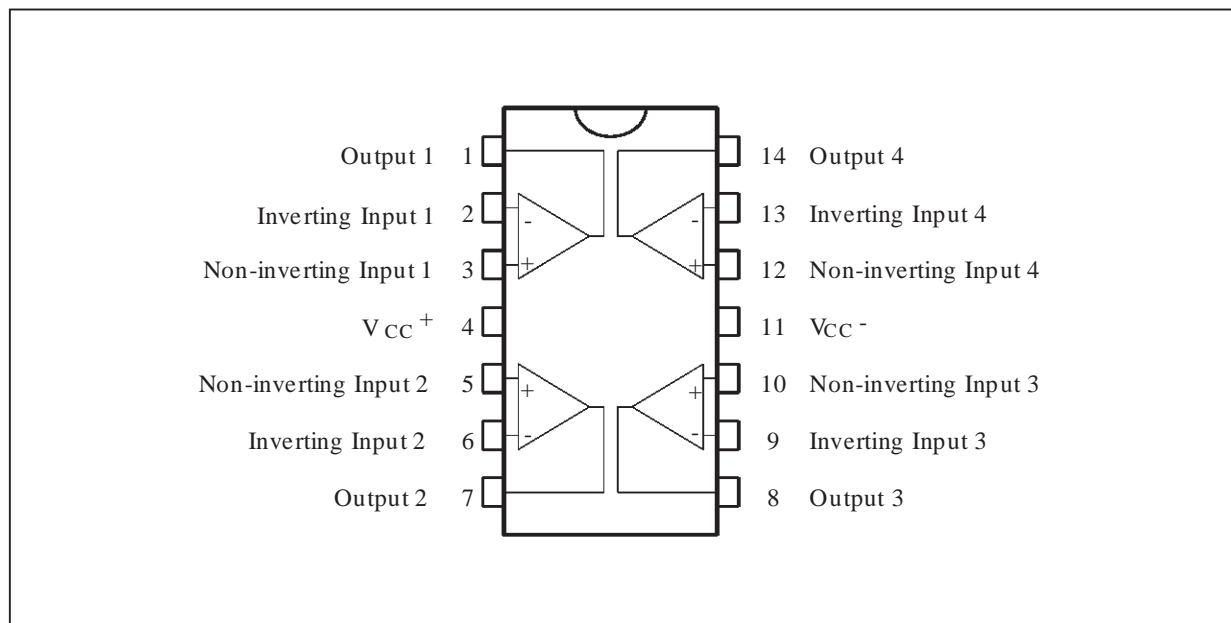

SCHMATIC DIAGRAM (1/4 LS404)

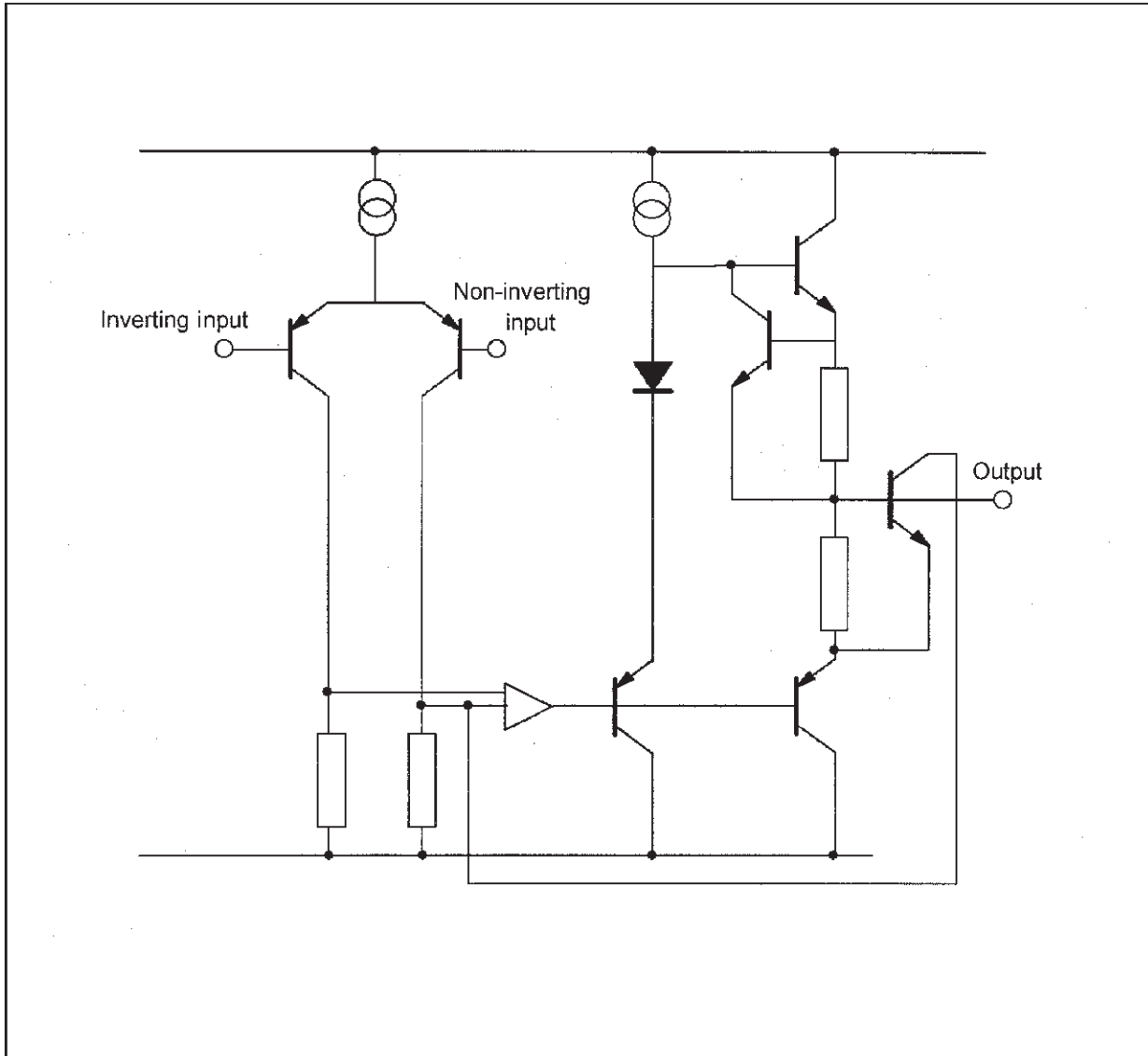

ABSOLUTE MAXIMUM RATINGS

Symbol	Parameter	Value	Unit
V_{CC}	Supply Voltage	± 18	V
V_i	Input Voltage (positive) (negative)	$+V_{CC}$ $-V_{CC} - 0.5$	V
V_{id}	Differential Input Voltage	$\pm (V_{CC} - 1)$	
T_{oper}	Operating Temperature Range	LS404C LS404I LS404M 0 to +70 -40 to +105 -55 to +125	$^{\circ}C$
P_{tot}	Power Dissipation at $T_{amb} = 70^{\circ}C$	400	mW
T_{stg}	Storage Temperature	-65 to 150	$^{\circ}C$

ELECTRICAL CHARACTERISTICS ($V_{CC} = \pm 15V$, $T_{amb} = 25^{\circ}C$, unless otherwise specified)

Symbol	Parameter	Test Conditions	LS404I - LM401M			LS404C			Unit
			Min.	Typ.	Max.	Min.	Typ.	Max.	
I_{CC}	Supply Current			1.3	2		1.5	3	mA
I_{ib}	Input Bias Current			50	200		100	300	nA
R_i	Input Resistance	$f = 1kHz$		1			1		M Ω
V_{io}	Input Offset Voltage	$R_s \leq 10k\Omega$		0.7	2.5		0.5	5	mV
DV_{io}	Input Offset Voltage Drift	$R_s \leq 10k\Omega$ $T_{min.} < T_{op} < T_{max.}$		5			5		$\mu V/^{\circ}C$
I_{io}	Input Offset Current			10	40		20	80	nA
DI_{io}	Input Offset Current Drift	$T_{min.} < T_{op} < T_{max.}$		0.08			0.1		$\frac{nA}{^{\circ}C}$
I_{os}	Output Short Circuit Current			23			23		mA
A_{vd}	Large Signal Voltage Gain	$R_L = 2k\Omega$ $V_{CC} = \pm 15V$ $V_{CC} = \pm 4V$	90	100 95		86	100 95		dB
GBP	Gain-Bandwidth Product	$f = 100kHz$ $R_L = 2k\Omega$ $C_L = 100pF$	1.8	3		1.5	2.5		MHz
e_n	Equivalent Input Noise Voltage	$f = 1kHz$ $R_s = 50\Omega$ $R_s = 1k\Omega$ $R_s = 10k\Omega$		8 10 18	15		10 12 20		$\frac{nV}{\sqrt{Hz}}$
THD	Total Harmonic Distortion	Unity Gain $R_L = 2k\Omega$, $V_o = 2V_{pp}$ $f = 1kHz$ $f = 20kHz$		0.01 0.03	0.4		0.01 0.03		%
$\pm V_{opp}$	Output Voltage Swing	$R_L = 2k\Omega$ $V_{CC} = \pm 15V$ $V_{CC} = \pm 4V$	± 13	± 3		± 13	± 3		V
V_{opp}	Large Signal Voltage Swing	$f = 10kHz$ $R_L = 10k\Omega$ $R_L = 1k\Omega$		22 20			22 20		V_{PP}
SR	Slew Rate	Unity Gain, $R_L = 2k\Omega$	0.8	1.5			1		V/ μs
CMR	Common Mode Rejection Ratio	$V_{ic} = 10V$	90	94		80	90		dB
SVR	Supply Voltage Rejection Ratio	$V_{ic} = 1V$ $f = 100Hz$	90	94		86	90		dB
V_{O1}/V_{O2}	Channel Separation	$f = 1kHz$	100	120			120		dB

Figure 1 : Supply Current versus Supply Voltage

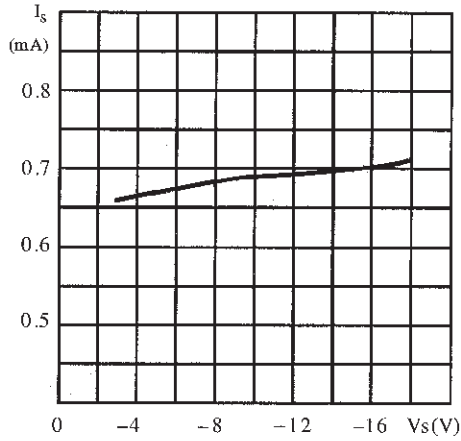

Figure 2 : Supply Current versus Ambient Temperature

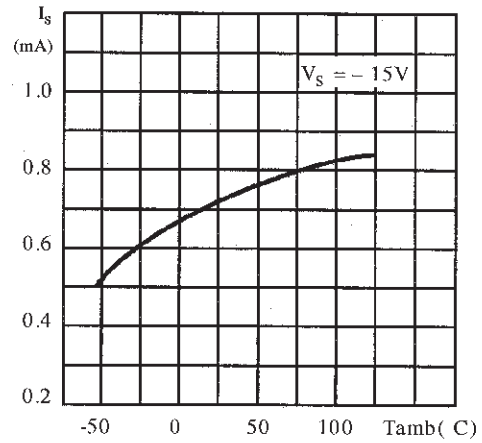

Figure 3 : Output Short Circuit Current versus Ambient Temperature

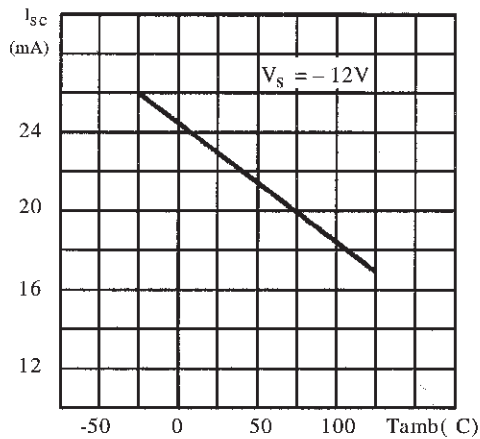

Figure 4 : Open Loop Frequency and Phase Response

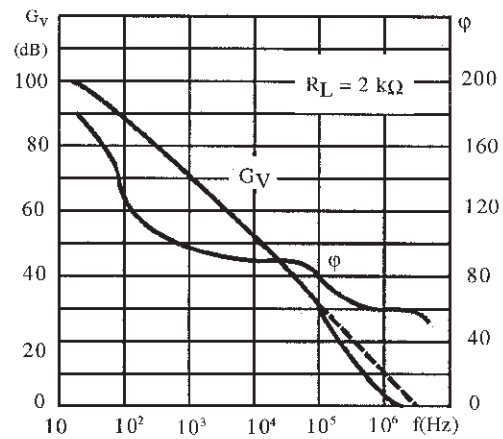

Figure 5 : Output Loop Gain versus Ambient Temperature

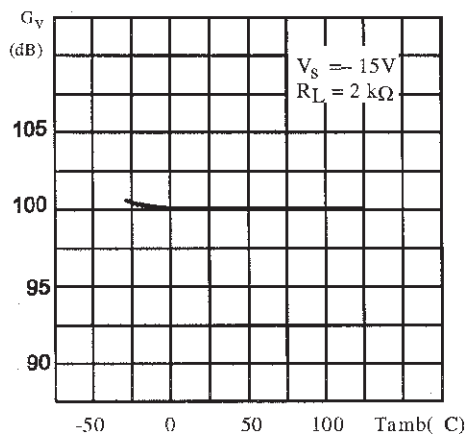

Figure 6 : Supply Voltage Rejection versus Frequency

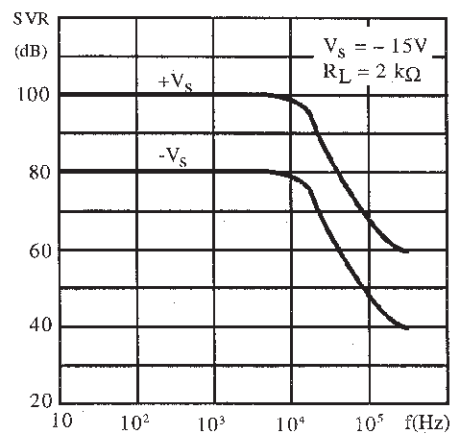

Figure 7 : Large Signal Frequency Response

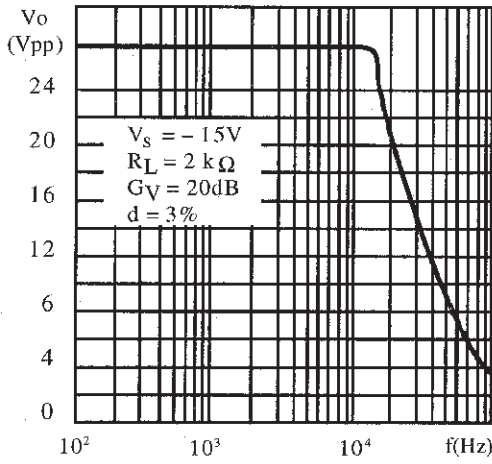

Figure 8 : Output Voltage Swing versus Load Resistance

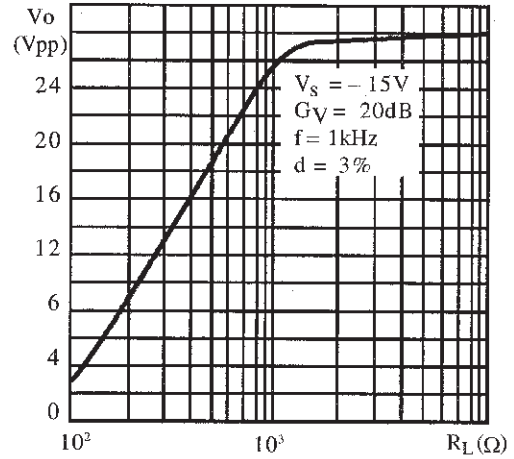

Figure 9 : Total Input Noise versus Frequency

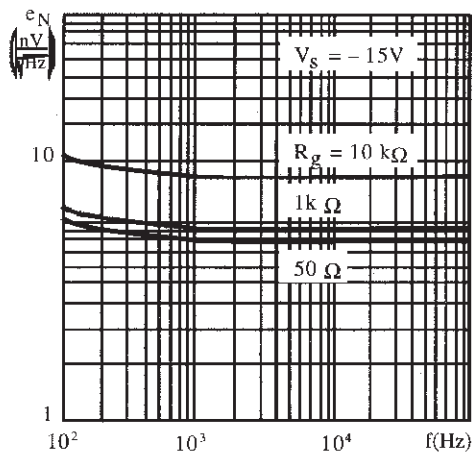

Figure 10 : Amplitude Response

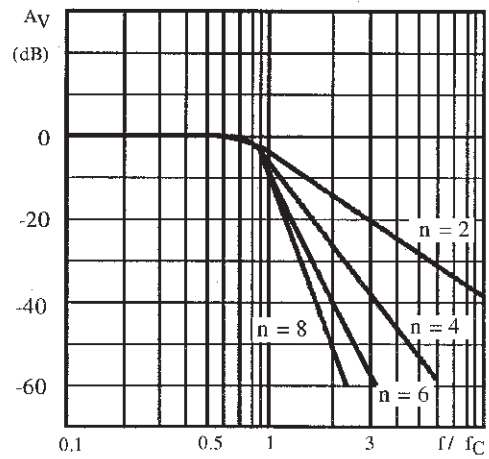

Figure 11 : Amplitude Response

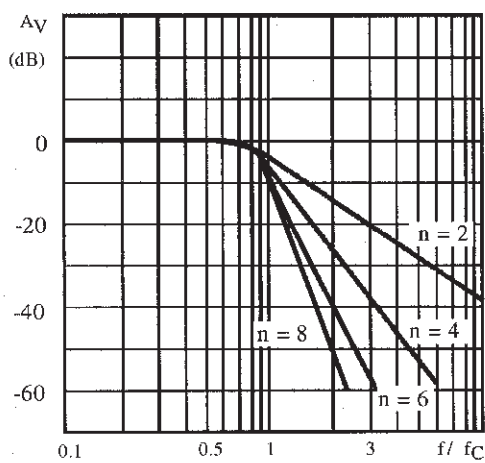
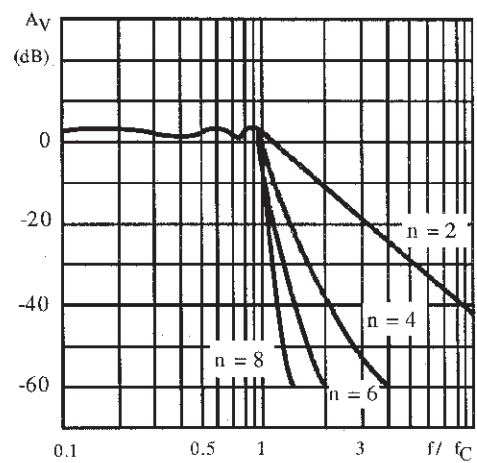

Figure 12 : Amplitude Response (±1dB ripple)



APPLICATION INFORMATION : Active low-pass filter

BUTTERWORTH

The Butterworth is a "maximally flat" amplitude response filter. Butterworth filters are used for filtering signals in data acquisition systems to prevent aliasing errors in sampled-data applications and for general purpose low-pass filtering.

The cut-off frequency f_c , is the frequency at which the amplitude response is down 3dB. The attenuation rate beyond the cutoff frequency is $n6$ dB per octave of frequency where n is the order (number of poles) of the filter.

Other characteristics :

- Flattest possible amplitude response.
- Excellent gain accuracy at low frequency end of passband.

BESSEL

The Bessel is a type of "linear phase" filter. Because of their linear phase characteristics, these filters approximate a constant time delay over a limited frequency range. Bessel filters pass transient waveforms with a minimum of distortion. They are also used to provide time delays for low pass filtering of modulated waveforms and as a "running average" type filter.

The maximum phase shift is $\frac{-n\pi}{2}$ radians where n is the order (number of poles) of the filter. The cut-off frequency f_c , is defined as the frequency at which the phase shift is one half of this value. For accurate delay, the cut-off frequency should be twice the

maximum signal frequency.

The following table can be used to obtain the -3dB frequency of the filter.

	2 pole	4 Pole	6 Pole	8 Pole
-3dB Frequency	$0.77f_c$	$0.67f_c$	$0.57f_c$	$0.50f_c$

Other characteristics :

- Selectivity not as great as Chebyshev or Butterworth.
- Very little overshoot response to step inputs.
- Fast rise time.

CHEBYSCHEV

Chebyshev filters have greater selectivity than either Bessel or Butterworth at the expense of ripple in the passband.

Chebyshev filters are normally designed with peak-to-peak ripple values from 0.2dB to 2dB.

Increased ripple in the passband allows increased attenuation above the cut-off frequency.

The cut-off frequency is defined as the frequency at which the amplitude response passes through the specified maximum ripple band and enters the stop band.

Other characteristics :

- Greater selectivity
- Very non-linear phase response
- High overshoot response to step inputs

The table below shows the typical overshoot and settling time response of the low pass filters to a step input.

	Number of Poles	Peak Overshoot	Settling Time (% of final value)		
		% Overshoot	$\pm 1\%$	$\pm 0.1\%$	$\pm 0.01\%$
Butterworth	2	4	$1.1/f_c$ sec.	$1.7/f_c$ sec.	$1.9/f_c$ sec.
	4	11	$1.7/f_c$	$2.8/f_c$	$3.8/f_c$
	6	14	$2.4/f_c$	$3.9/f_c$	$5.0/f_c$
	8	16	$3.1/f_c$	$5.1/f_c$	$7.1/f_c$
Bessel	2	0.4	$0.8/f_c$	$1.4/f_c$	$1.7/f_c$
	4	0.8	$1.0/f_c$	$1.8/f_c$	$2.4/f_c$
	6	0.6	$1.3/f_c$	$2.1/f_c$	$2.7/f_c$
	8	0.3	$1.6/f_c$	$2.3/f_c$	$3.2/f_c$
Chebyshev (ripple ± 0.25 dB)	2	11	$1.1/f_c$	$1.6/f_c$	—
	4	18	$3.0/f_c$	$5.4/f_c$	—
	6	21	$5.9/f_c$	$10.4/f_c$	—
	8	23	$8.4/f_c$	$16.4/f_c$	—
Chebyshev (ripple ± 1 dB)	2	21	$1.6/f_c$	$2.7/f_c$	—
	4	28	$4.8/f_c$	$8.4/f_c$	—
	6	32	$8.2/f_c$	$16.3/f_c$	—
	8	34	$11.6/f_c$	$24.8/f_c$	—

Design of 2nd order active low pass filter (Sallen and Key configuration unity gain-op-amp)

204-04 TEL

Fixed $R = R_1 = R_2$, we have (see fig. 13).

$$C1 = \frac{1}{R} \frac{\xi}{\omega_c}$$

$$C2 = \frac{1}{R} \frac{1}{\xi \omega_c}$$

The diagram of fig.14 shows the amplitude response for different values of damping factor ξ in 2nd order filters.

Figure 13 : Filter Configuration

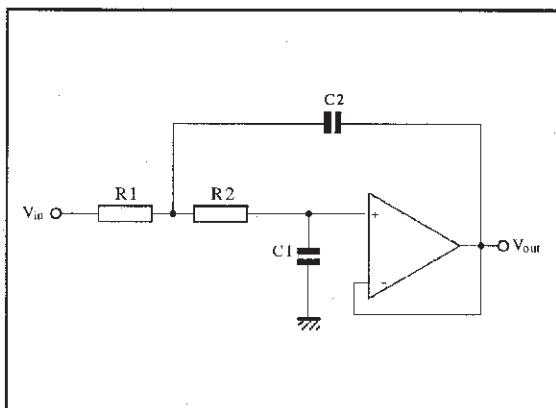

Three parameters are needed to characterize the frequency and phase response of a 2nd order active filter : the gain (G_V), the damping factor (ξ) or the Q-factor ($Q = (2 \xi)^{-1}$), and the cutoff frequency (f_c).

The higher order responses are obtained with a se-

Figure 14 : Filter Respons versus Damping Factor

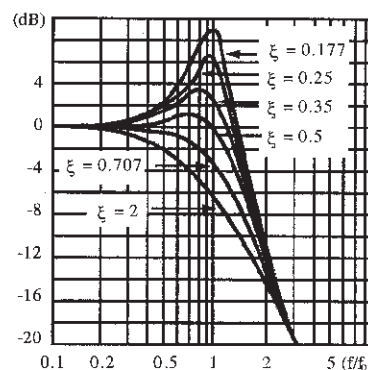

ries of 2nd order sections. A simple RC section is introduced when an odd filter is required.

The choice of ' ξ ' (or Q-factor) determines the filter response (see table 1).

Table 1

Filter Response	ξ	Q	Cutoff Frequency f_c
Bessel	$\frac{\sqrt{3}}{2}$	$\frac{\sqrt{1}}{3}$	Frequency at which Phase Shift is -90°
Butterworth	$\frac{\sqrt{2}}{2}$	$\frac{\sqrt{1}}{2}$	Frequency at which $G_V = -3\text{dB}$
Chebyshev	$\frac{\sqrt{2}}{2}$	$\frac{\sqrt{1}}{2}$	Frequency at which the amplitude response passes through specified max. ripple band and enters the stop band.

EXAMPLE

Figure 15 : 5th Order Low-pass Filter (Butterworth) with Unity Gain Configuration

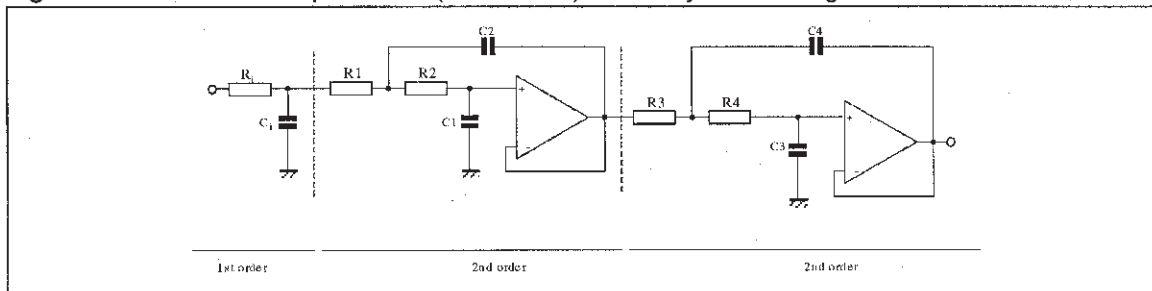

In the circuit of fig. 15, for $f_c = 3.4\text{kHz}$ and $R_i = R_1 = R_2 = R_3 = R_4 = 10\text{k}\Omega$, we obtain :

$$C_i = 1.354 \cdot \frac{1}{R} \cdot \frac{1}{2\pi f_c} = 6.33\text{nF}$$

$$C_1 = 0.421 \cdot \frac{1}{R} \cdot \frac{1}{2\pi f_c} = 1.97\text{nF}$$

$$C_2 = 1.753 \cdot \frac{1}{R} \cdot \frac{1}{2\pi f_c} = 8.20\text{nF}$$

$$C_3 = 0.309 \cdot \frac{1}{R} \cdot \frac{1}{2\pi f_c} = 1.45\text{nF}$$

$$C_4 = 3.325 \cdot \frac{1}{R} \cdot \frac{1}{2\pi f_c} = 15.14\text{nF}$$

The attenuation of the filter is 30dB at 6.8kHz and better than 60dB at 15kHz.

The same method, referring to Tab. 2 and fig. 16, is used to design high-pass filter. In this case the damping factor is found by taking the reciprocal of the numbers in Tab. 2. For $f_c = 5\text{kHz}$ and $C_i = C_1 = C_2 = C_3 = C_4 = 1\text{nF}$ we obtain :

$$R_i = \frac{1}{0.354} \cdot \frac{1}{C} \cdot \frac{1}{2\pi f_c} = 25.5\text{k}\Omega$$

$$R_1 = \frac{1}{0.421} \cdot \frac{1}{C} \cdot \frac{1}{2\pi f_c} = 75.6\text{k}\Omega$$

$$R_2 = \frac{1}{1.753} \cdot \frac{1}{C} \cdot \frac{1}{2\pi f_c} = 18.2\text{k}\Omega$$

$$R_3 = \frac{1}{0.309} \cdot \frac{1}{C} \cdot \frac{1}{2\pi f_c} = 103\text{k}\Omega$$

$$R_4 = \frac{1}{3.325} \cdot \frac{1}{C} \cdot \frac{1}{2\pi f_c} = 9.6\text{k}\Omega$$

Table 2 : Damping Factor for Low-pass Butterworth Filters

Order	C_i	C_1	C_2	C_3	C_4	C_5	C_6	C_7	C_8
2		0.707	1.41						
3	1.392	0.202	3.54						
4		0.92	1.08	0.38	2.61				
5	1.354	0.421	1.75	0.309	3.235				
6		0.966	1.035	0.707	1.414	0.259	3.86		
7	1.336	0.488	1.53	0.623	1.604	0.222	4.49		
8		0.98	1.02	0.83	1.20	0.556	1.80	0.195	5.125

Figure 16 : 5th Order High-pass Filter (Butterworth) with Unity Gain Configuration

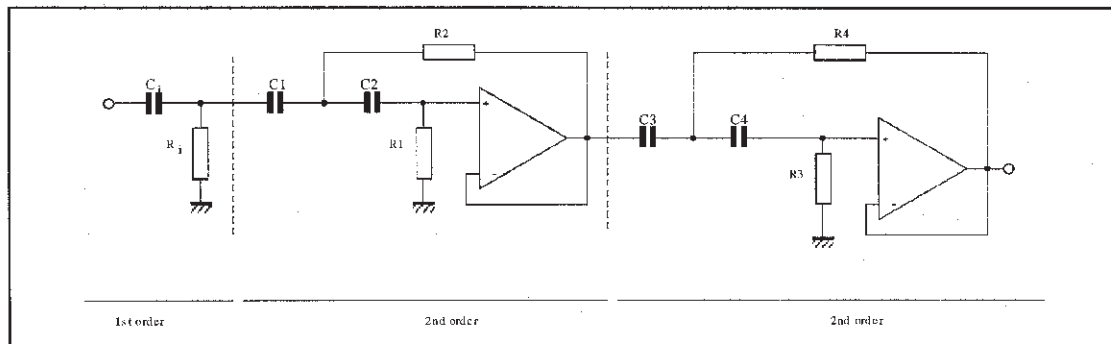

Figure 17 : Multiple Feedback 8-pole Bandpass Filter

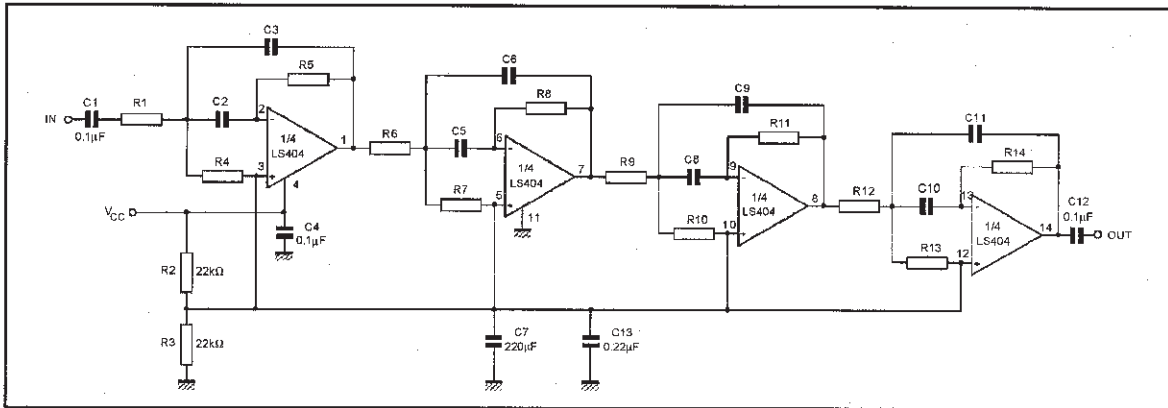

Figure 18 : Frequency Response of Bandpass Filter

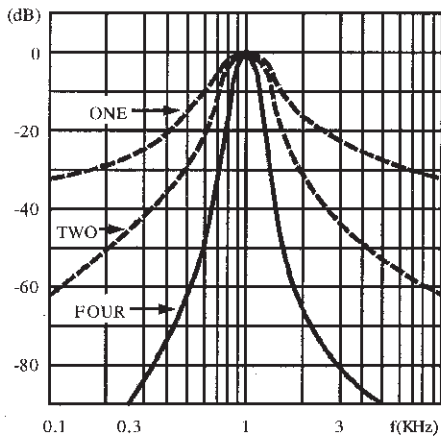

Figure 19 : Bandwidth of Bandpass Filter

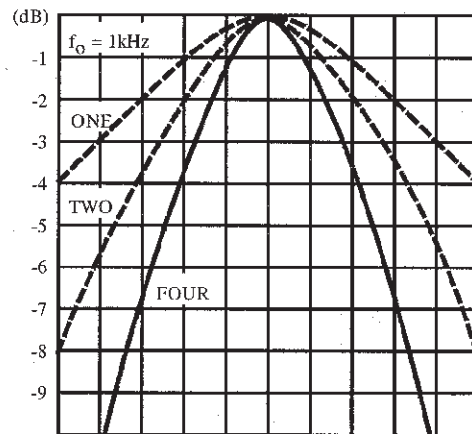
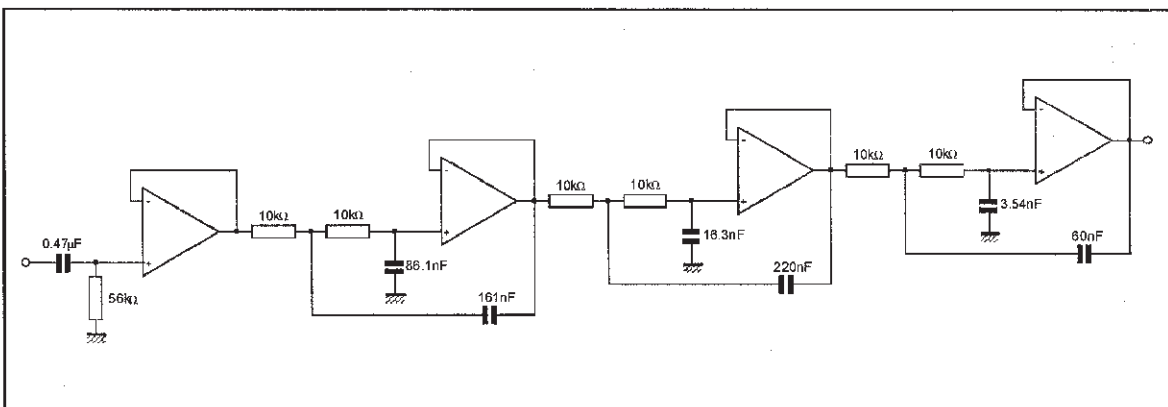

Figure 20 : Six-pole 355Hz Low-pass Filter (chebychev type)



This is a 6-pole Chebyshev type with ± 0.25 dB ripple in the passband. A decoupling stage is used to avoid the influence of the input impedance on the filter's characteristics. The attenuation is about 55dB at

710Hz and reaches 80dB at 1065Hz. The in band attenuation is limited in practise to the ± 0.25 dB ripple and does not exceed 0.5dB at 0.9fc.

Figure 21 : Subsonic Filter ($G_V = 0\text{dB}$)

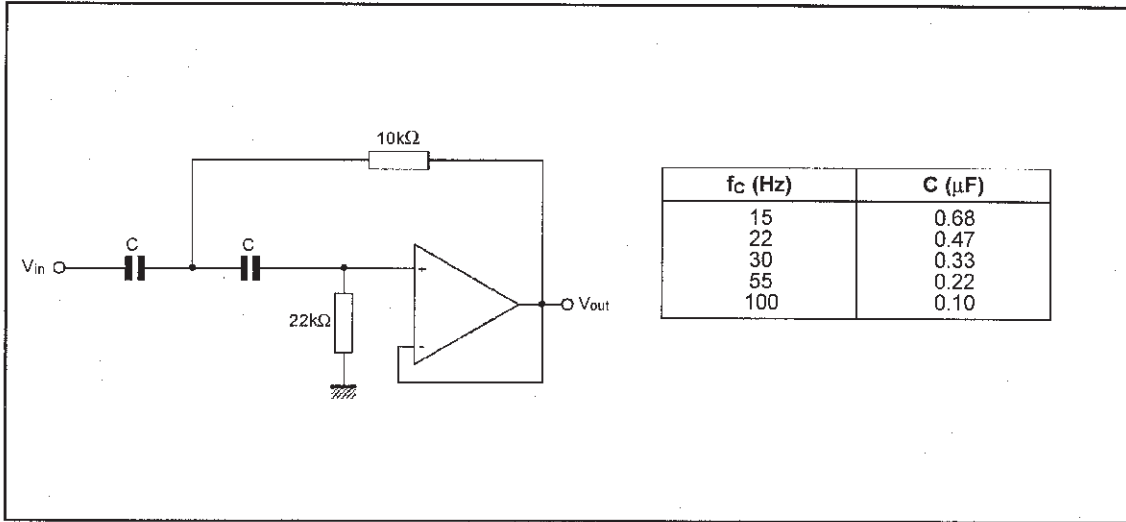
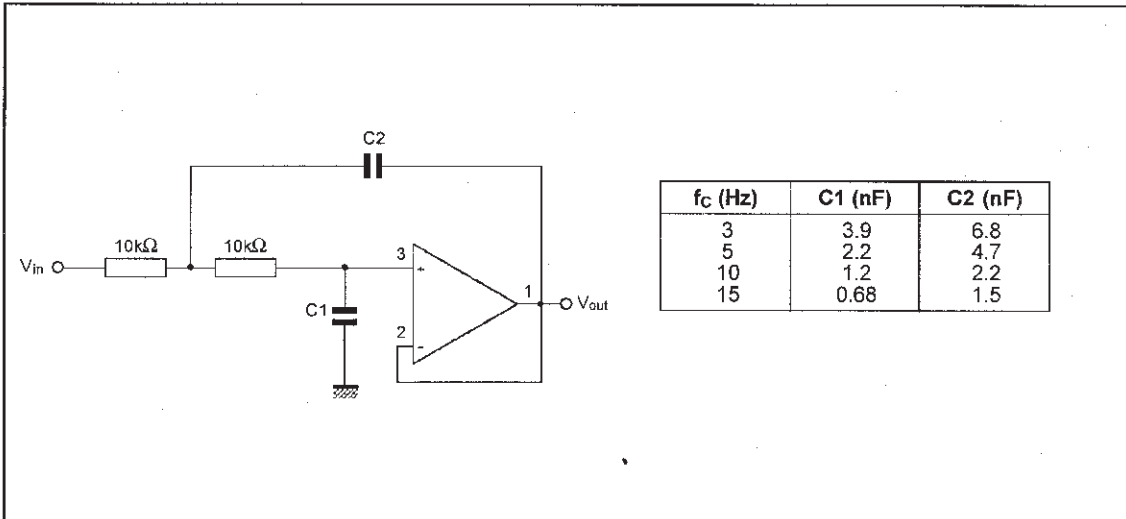
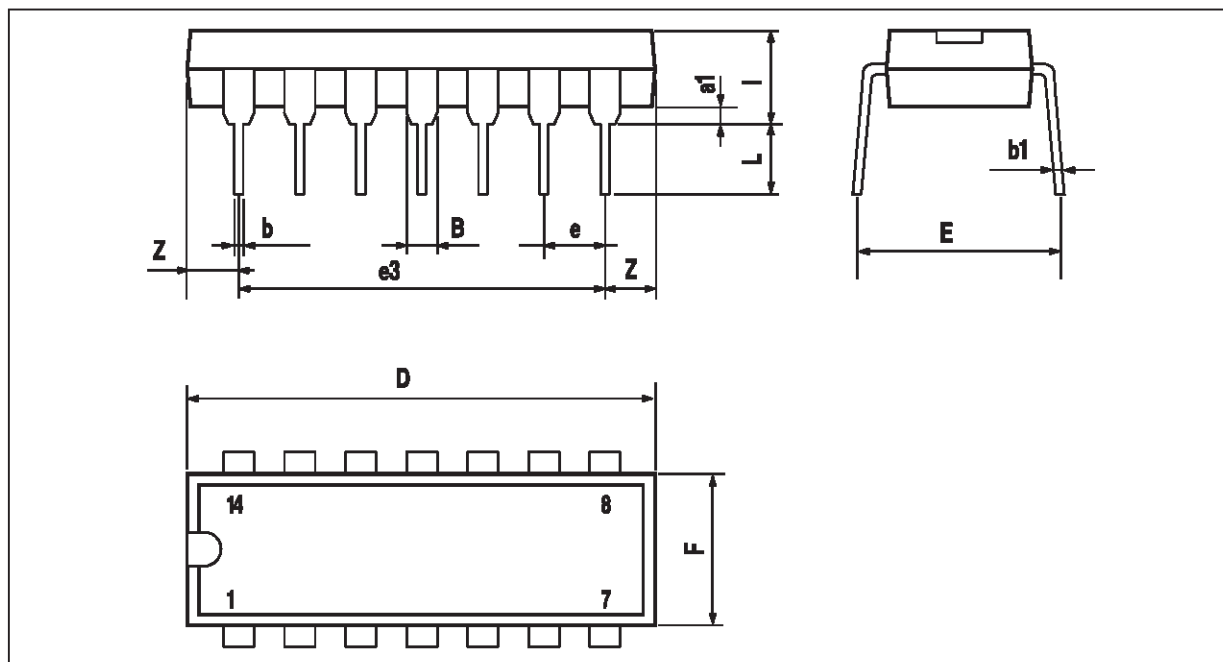

Figure 22 : High Cut Filter ($G_V = 0\text{dB}$)



PACKAGE MECHANICAL DATA

14 PINS - PLASTIC DIP



Dim.	Millimeters			Inches		
	Min.	Typ.	Max.	Min.	Typ.	Max.
a1	0.51			0.020		
B	1.39		1.65	0.055		0.065
b		0.5			0.020	
b1		0.25			0.010	
D			20			0.787
E		8.5			0.335	
e		2.54			0.100	
e3		15.24			0.600	
F			7.1			0.280
i			5.1			0.201
L		3.3			0.130	
Z	1.27		2.54	0.050		0.100

PACKAGE MECHANICAL DATA
 14 PINS - PLASTIC MICROPACKAGE (SO)

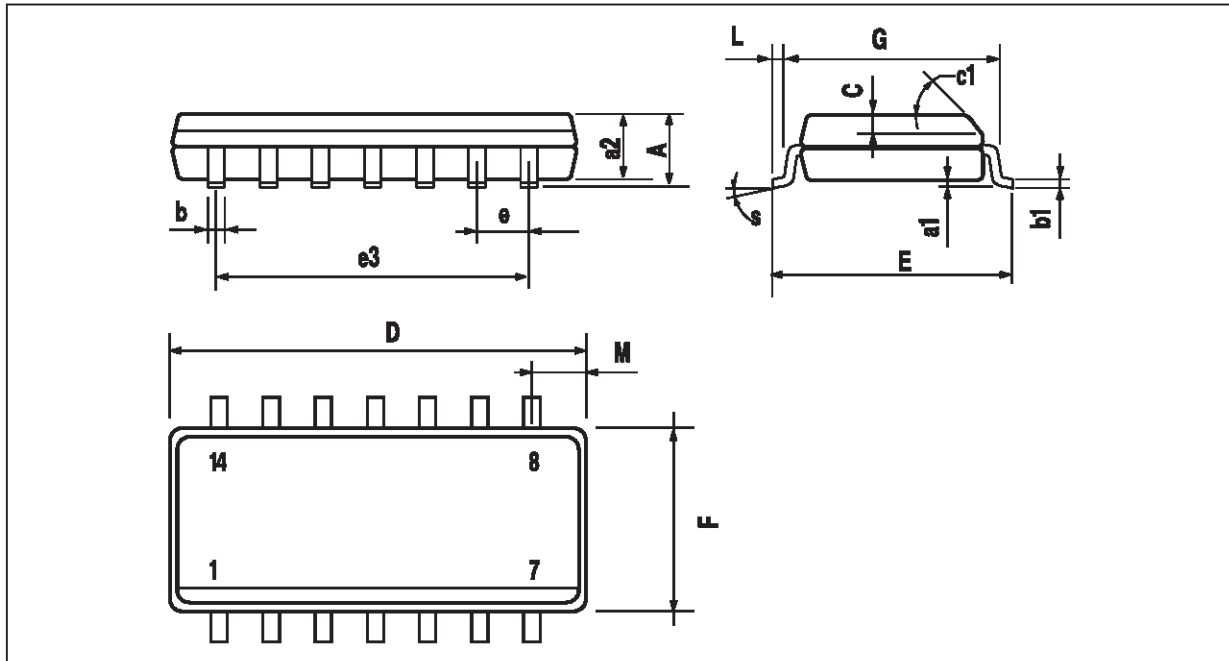

Dim.	Millimeters			Inches		
	Min.	Typ.	Max.	Min.	Typ.	Max.
A			1.75			0.069
a1	0.1		0.2	0.004		0.008
a2			1.6			0.063
b	0.35		0.46	0.014		0.018
b1	0.19		0.25	0.007		0.010
C		0.5			0.020	
c1	45° (typ.)					
D	8.55		8.75	0.336		0.334
E	5.8		6.2	0.228		0.244
e		1.27			0.050	
e3		7.62			0.300	
F	3.8		4.0	0.150		0.157
G	4.6		5.3	0.181		0.208
L	0.5		1.27	0.020		0.050
M			0.68			0.027
S	8° (max.)					

Information furnished is believed to be accurate and reliable. However, SGS-THOMSON Microelectronics assumes no responsibility for the consequences of use of such information nor for any infringement of patents or other rights of third parties which may result from its use. No license is granted by implication or otherwise under any patent or patent rights of SGS-THOMSON Microelectronics. Specifications mentioned in this publication are subject to change without notice. This publication supersedes and replaces all information previously supplied. SGS-THOMSON Microelectronics products are not authorized for use as critical components in life support devices or systems without express written approval of SGS-THOMSON Microelectronics.

© 1997 SGS-THOMSON Microelectronics – Printed in Italy – All Rights Reserved

SGS-THOMSON Microelectronics GROUP OF COMPANIES
 Australia - Brazil - Canada - China - France - Germany - Italy - Japan - Korea - Malaysia - Malta - Morocco
 The Netherlands - Singapore - Spain - Sweden - Switzerland - Taiwan - Thailand - United Kingdom - U.S.A.