

## FOUR UA741 QUAD BIPOLAR OPERATIONAL AMPLIFIERS

- LOW SUPPLY CURRENT : 0.53mA/AMPLIFIER
- CLASS AB OUTPUT STAGE : NO CROSS-OVER DISTORTION
- PIN COMPATIBLE WITH LM124
- LOW INPUT OFFSET VOLTAGE : 1mV
- LOW INPUT OFFSET CURRENT : 2nA
- LOW INPUT BIAS CURRENT : 30nA
- GAIN BANDWIDTH PRODUCT : 1.3MHz
- HIGH DEGREE OF ISOLATION BETWEEN AMPLIFIERS : 120dB
- OVERLOAD PROTECTION FOR INPUTS AND OUTPUTS

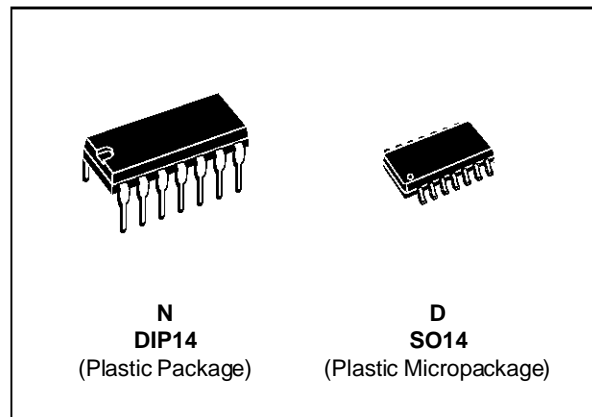

### ORDER CODES

Part Number	Temperature Range	Package	
		N	D
LM148	-55°C, +125°C	•	•
LM248	-40°C, +105°C	•	•
LM348	0°C, +70°C	•	•

**Example :** LM348D

### DESCRIPTION

The LM148 consists of four independent, high gain internally compensated, low power operational amplifiers which have been designed to provide functional characteristics identical to those of the familiar UA741 operational amplifier. In addition the total supply current for all four amplifiers is comparable to the supply current of a single UA741 type op amp. Other features include input offset current and input bias current which are much less than those of a standard UA741. Also, excellent isolation between amplifiers has been achieved by independently biasing each amplifier and using layout techniques which minimize thermal coupling.

The LM148 can be used anywhere multiple UA741 type amplifiers are being used and in applications where amplifier matching or high packing density is required.

### PIN CONNECTIONS (top view)

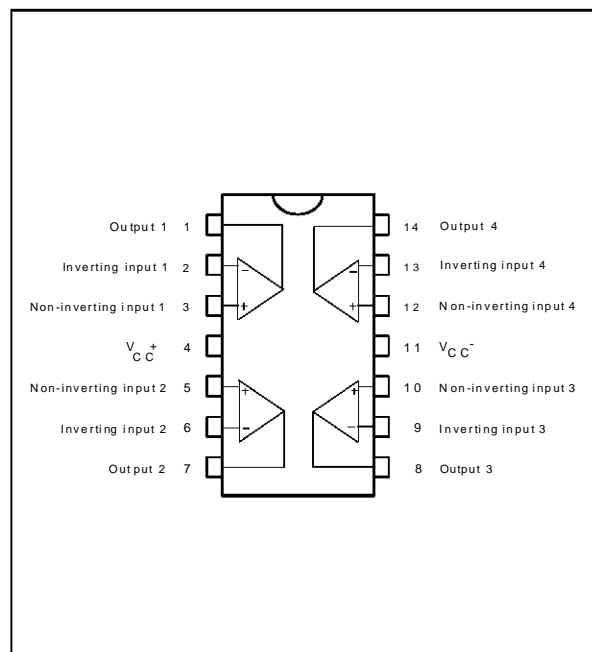

**SCHEMATIC DIAGRAM**

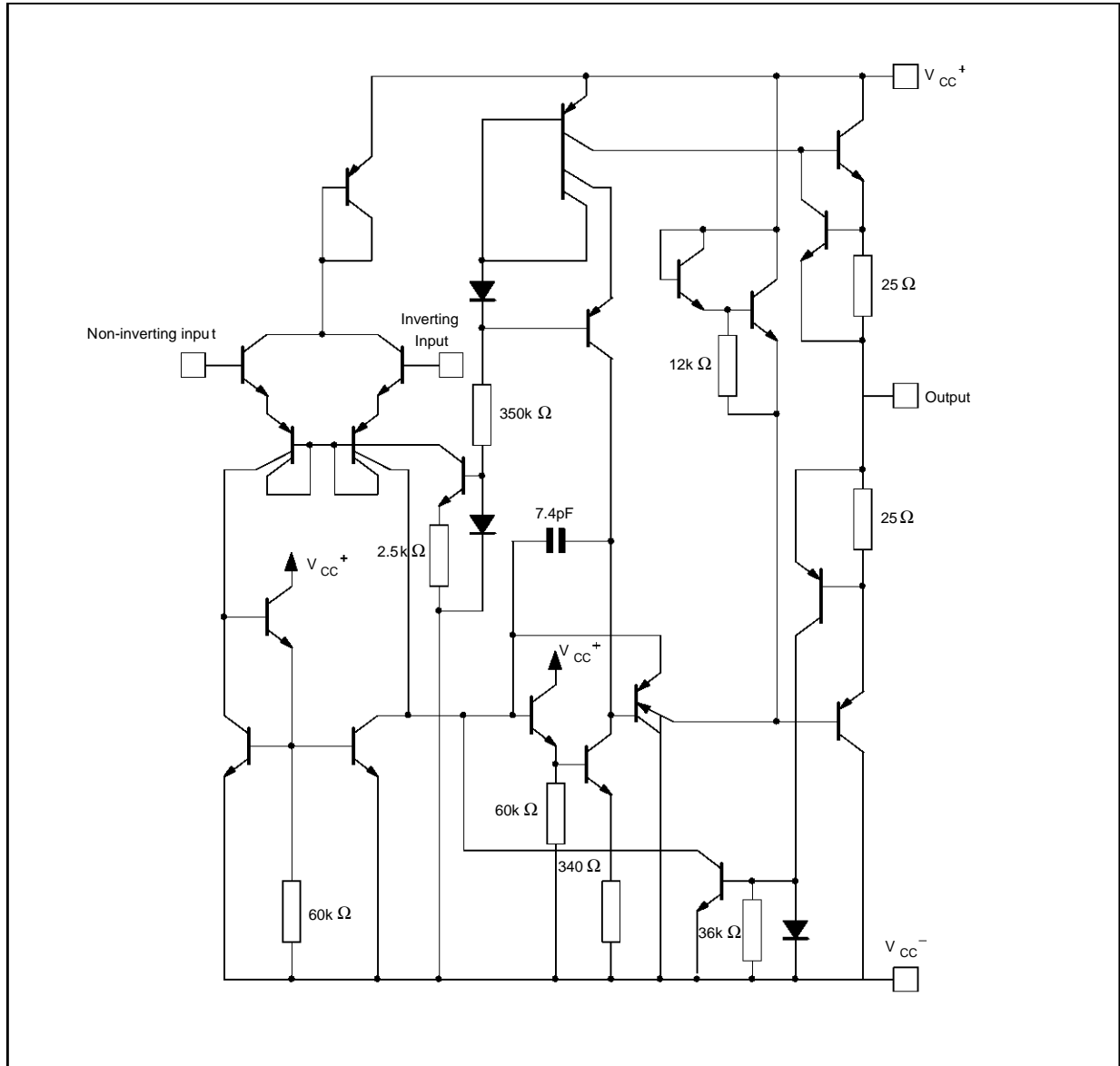

**ABSOLUTE MAXIMUM RATINGS**

Symbol	Parameter	LM148	LM248	LM348	Unit
V <sub>CC</sub>	Supply Voltage	± 22	± 22	± 22	V
V <sub>id</sub>	Differential Input Voltage	±44	± 44	± 44	V
V <sub>i</sub>	Input Voltage (note 1)	± 22	± 22	± 22	V
P <sub>tot</sub>	Power Dissipation	500	500	500	mW
	Output Short-circuit Duration (note 2)	Infinite			
T <sub>oper</sub>	Operating Free-air Temperature Range	-55, +125	-40, +105	0, +70	°C
T <sub>stg</sub>	Storage Temperature Range	-65, +150	-65, +150	-65, +150	°C

**Notes :** 1. For supply voltage less than maximum value, the absolute maximum input voltage is equal to the supply voltage.  
 2. Any of the amplifier outputs can be shorted to ground indefinitely ; however, more than one should not be simultaneously shorted as the maximum junction temperature will be exceeded.

**ELECTRICAL CHARACTERISTICS**

V<sub>CC</sub> = ±15V, T<sub>amb</sub> = 25°C (unless otherwise specified)

Symbol	Parameter	LM148 - LM248 - LM348			Unit
		Min.	Typ.	Max.	
V <sub>io</sub>	Input Offset Voltage (R <sub>S</sub> ≤ 10kΩ) T <sub>amb</sub> = 25°C T <sub>min.</sub> ≤ T <sub>amb</sub> ≤ T <sub>max.</sub>		1	5 6	mV
I <sub>io</sub>	Input Offset Current T <sub>amb</sub> = 25°C T <sub>min.</sub> ≤ T <sub>amb</sub> ≤ T <sub>max.</sub>		2	25 75	nA
I <sub>ib</sub>	Input Bias Current T <sub>amb</sub> = 25°C T <sub>min.</sub> ≤ T <sub>amb</sub> ≤ T <sub>max.</sub>		30	100 300	nA
A <sub>vd</sub>	Large Signal Voltage Gain (V <sub>o</sub> = ±10V, R <sub>L</sub> = 2kΩ) T <sub>amb</sub> = 25°C T <sub>min.</sub> ≤ T <sub>amb</sub> ≤ T <sub>max.</sub>	50 25	160		V/mV
SVR	Supply Voltage Rejection Ratio (R <sub>S</sub> ≤ 10kΩ) T <sub>amb</sub> = 25°C T <sub>min.</sub> ≤ T <sub>amb</sub> ≤ T <sub>max.</sub>	77 77	100		dB
I <sub>cc</sub>	Supply Current, all Amp, no Load T <sub>amb</sub> = 25°C T <sub>min.</sub> ≤ T <sub>amb</sub> ≤ T <sub>max.</sub>		2.1	3.6 4.8	mA
V <sub>icm</sub>	Input Common Mode Voltage Range T <sub>amb</sub> = 25°C T <sub>min.</sub> ≤ T <sub>amb</sub> ≤ T <sub>max.</sub>	±12 ±12			V
CMR	Common Mode Rejection Ratio (R <sub>S</sub> ≤ 10kΩ) T <sub>amb</sub> = 25°C T <sub>min.</sub> ≤ T <sub>amb</sub> ≤ T <sub>max.</sub>	70 70	110		dB
I <sub>os</sub>	Output Short-circuit Current T <sub>amb</sub> = 25°C	10	25	35	mA
± V <sub>opp</sub>	Output Voltage Swing T <sub>amb</sub> = 25°C T <sub>min.</sub> ≤ T <sub>amb</sub> ≤ T <sub>max.</sub> R <sub>L</sub> = 10kΩ R <sub>L</sub> = 2kΩ R <sub>L</sub> = 10kΩ R <sub>L</sub> = 2kΩ	12 10 12 10	13 12		V
SR	Slew Rate (V <sub>I</sub> = ±10V, R <sub>L</sub> = 10kΩ, C <sub>L</sub> = 100pF, unity Gain)	0.25	0.5		V/μs
t <sub>r</sub>	Rise Time (V <sub>I</sub> = ±10V, R <sub>L</sub> = 10kΩ, C <sub>L</sub> = 100pF, unity Gain)		0.3		μs
K <sub>Ov</sub>	Overshoot (V <sub>I</sub> = ±10V, R <sub>L</sub> = 10kΩ, C <sub>L</sub> = 100pF, unity Gain)		5		%
R <sub>I</sub>	Input Resistance	0.8	2.5		MΩ
GBP	Gain Bandwidth Product (V <sub>I</sub> = 10 mV, R <sub>L</sub> = 10kΩ, C <sub>L</sub> = 100pF, f = 100kHz)	0.7	1.3		MHz
THD	Total Harmonic Distortion (f = 1kHz, A <sub>v</sub> = 20dB, R <sub>L</sub> = 10kΩ, C <sub>L</sub> = 100pF, V <sub>o</sub> = 2V <sub>pp</sub> )		0.08		%
e <sub>n</sub>	Equivalent Input Noise Voltage (f = 1kHz, R <sub>S</sub> = 100Ω)		40		$\frac{nV}{\sqrt{Hz}}$
V <sub>o1</sub> /V <sub>o2</sub>	Channel Separation		120		dB

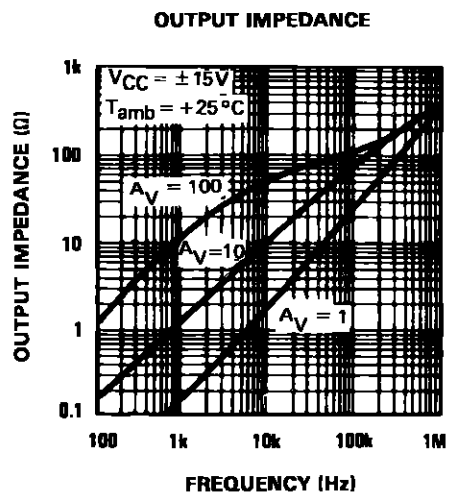
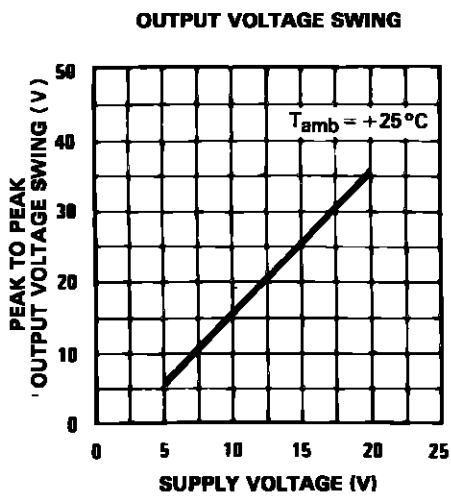
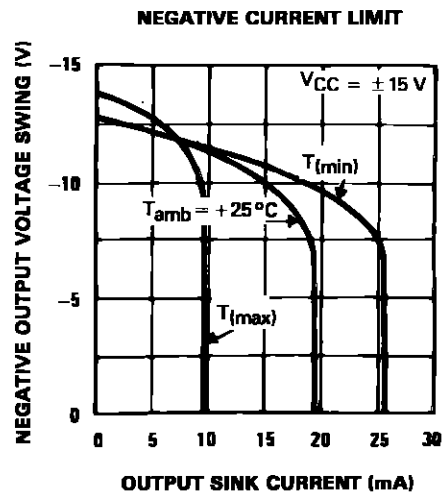
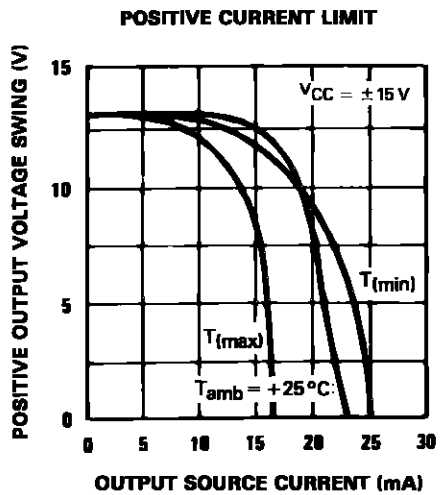
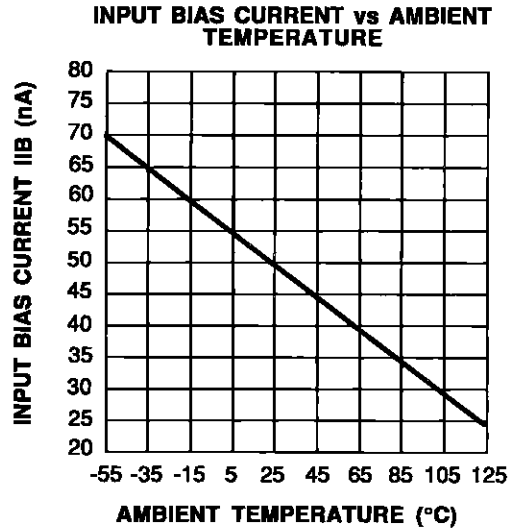
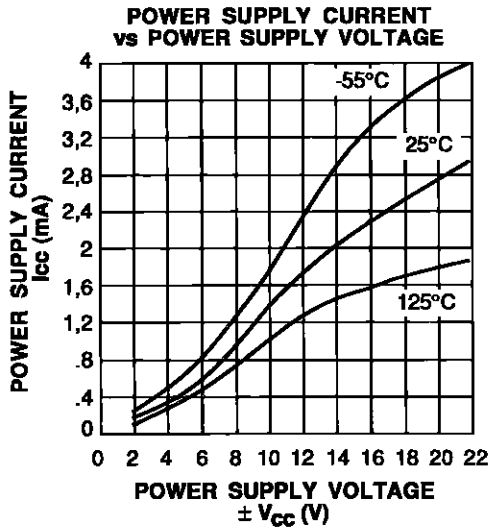

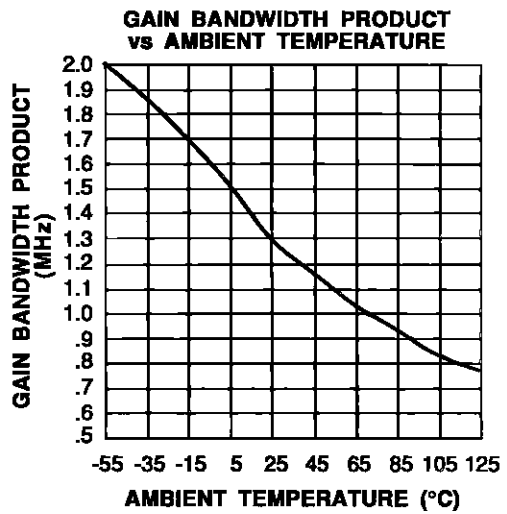
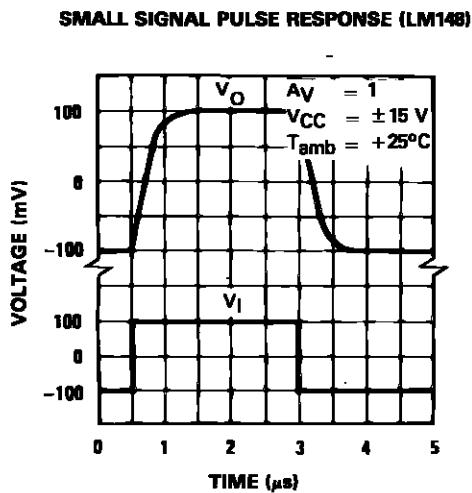
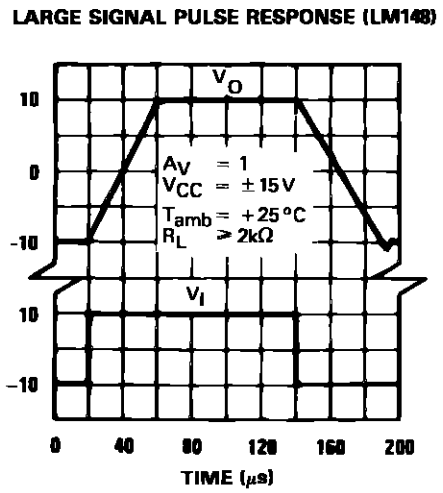
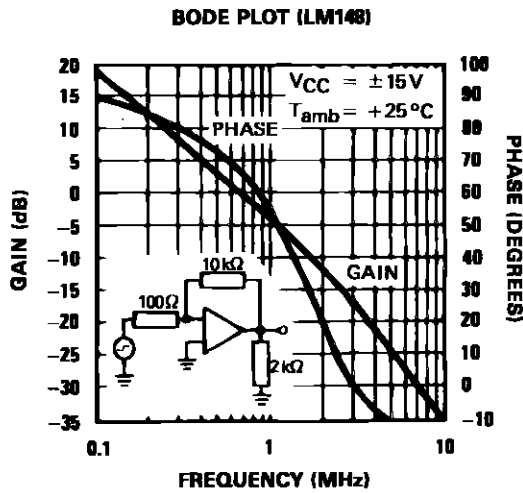
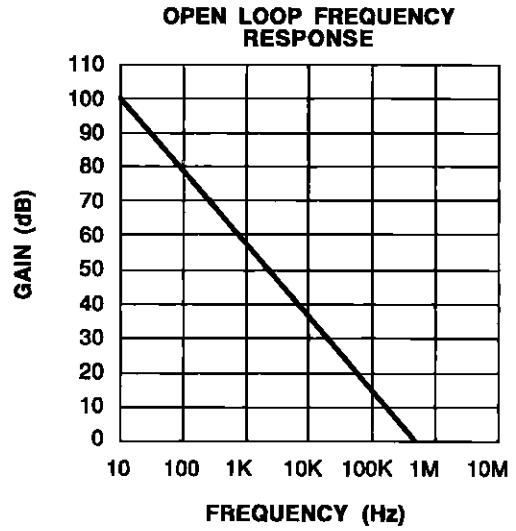
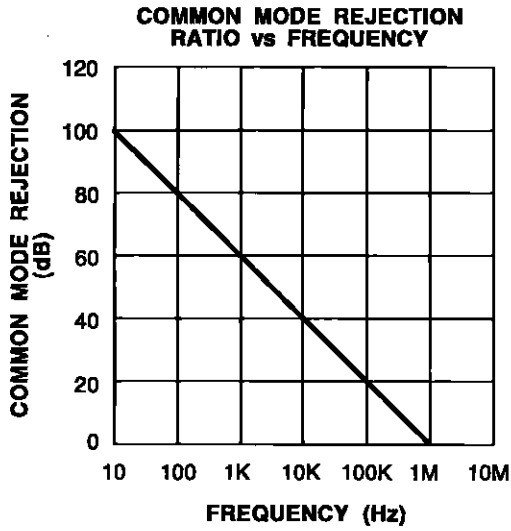

**INVERTING LARGE SIGNAL PULSE RESPONSE (LM148)**

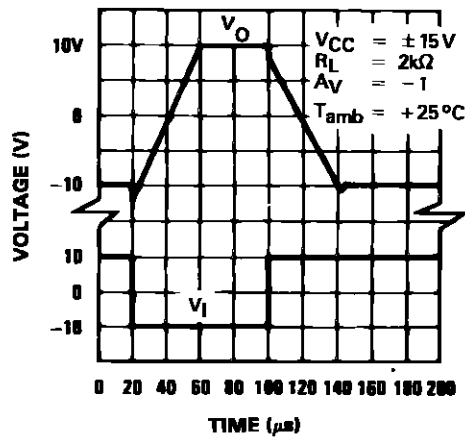

**SLEW-RATE vs TEMPERATURE**

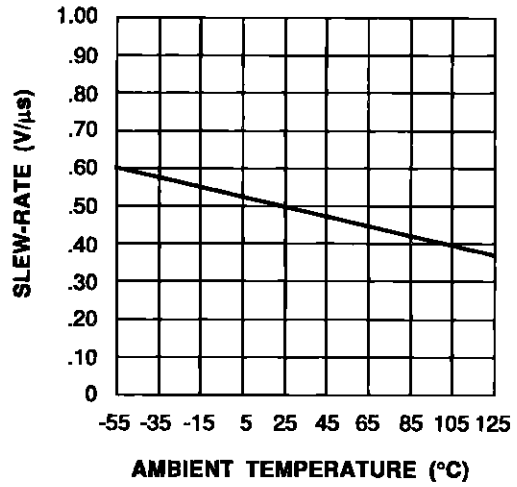

**EQUIVALENT INPUT NOISE vs FREQUENCY**

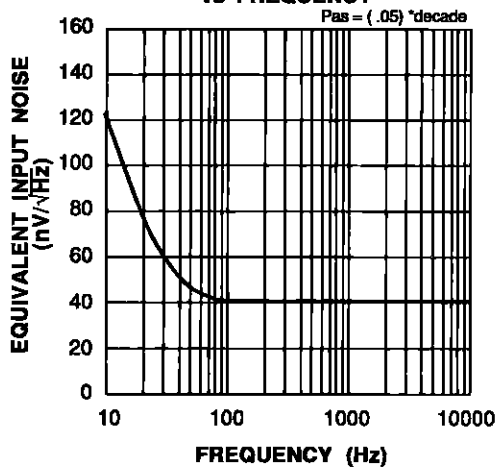

**UNDISTORTED OUTPUT VOLTAGE SWING**

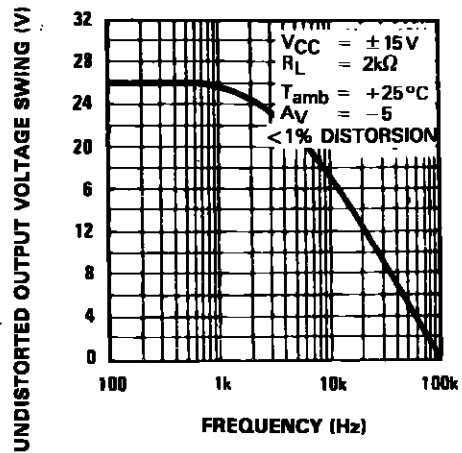

**POSITIVE COMMON-MODE INPUT VOLTAGE LIMIT**

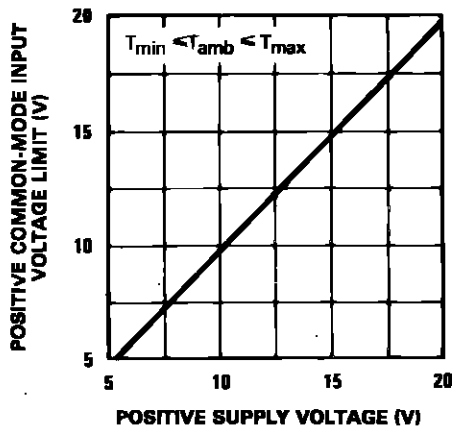

**NEGATIVE COMMON-MODE INPUT VOLTAGE LIMIT**

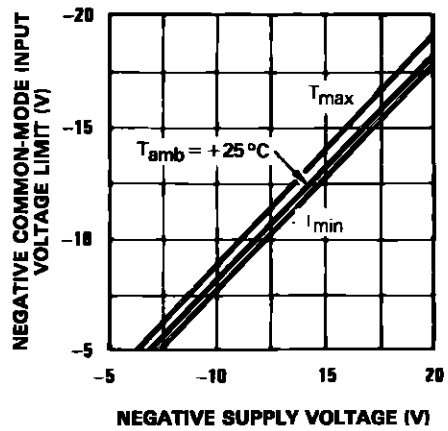

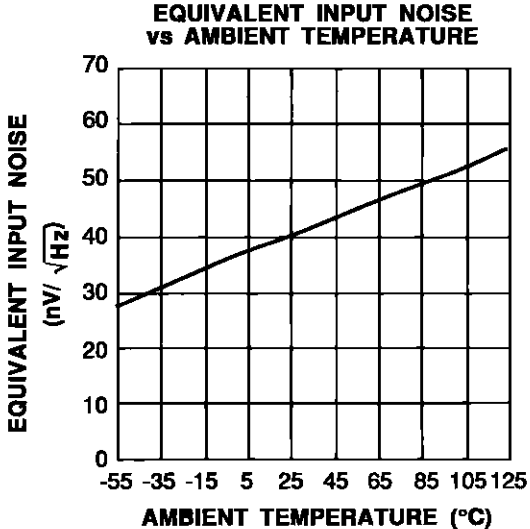
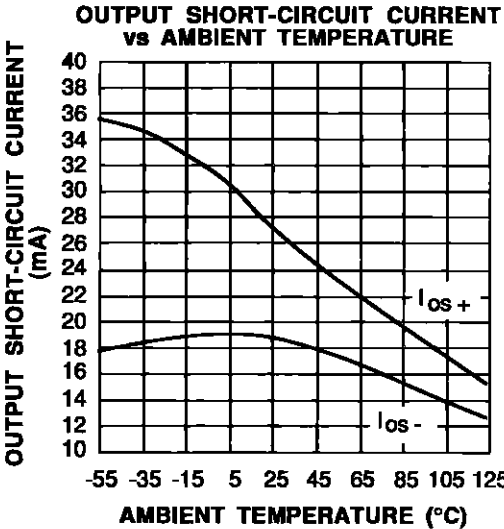

TEST CIRCUITS

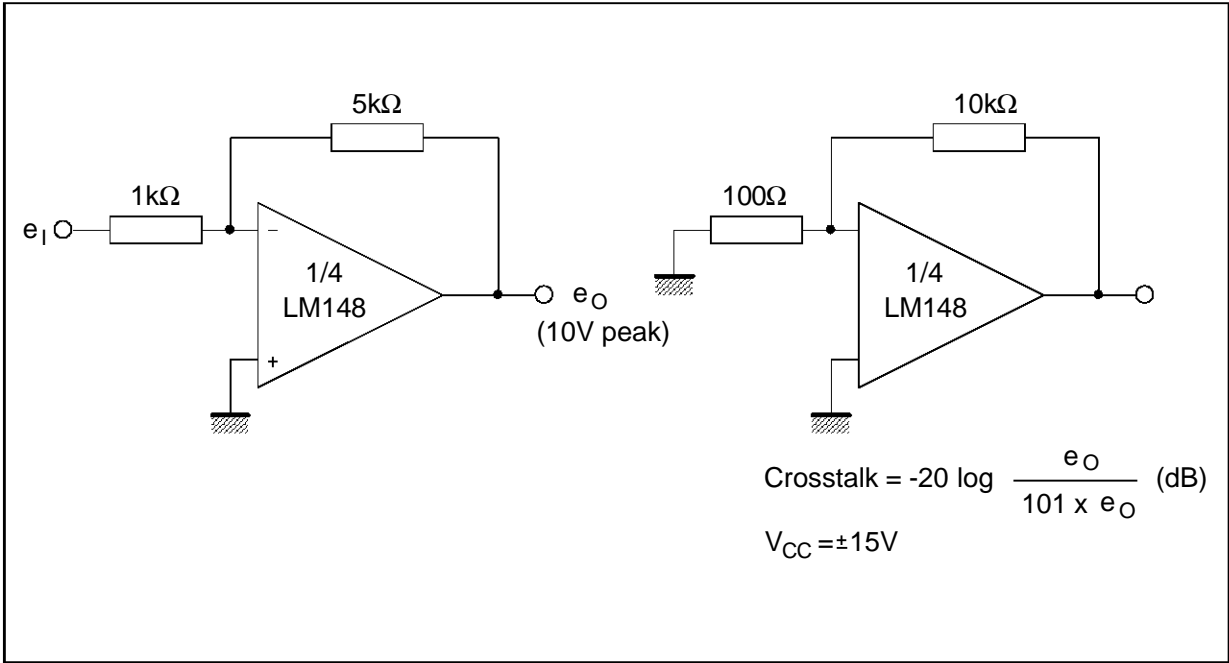

**LM148 - LM248 - LM348**

**PACKAGE MECHANICAL DATA**  
14 PINS - PLASTIC DIP

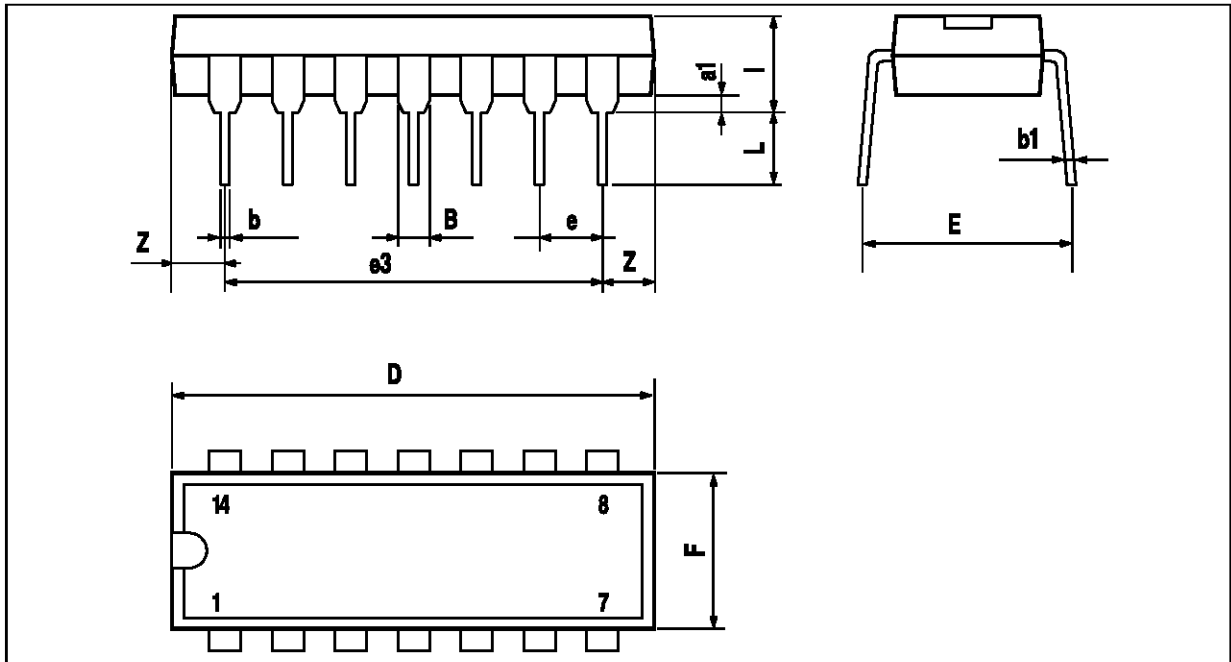

PM-DIP14LEPS

Dimensions	Millimeters			Inches		
	Min.	Typ.	Max.	Min.	Typ.	Max.
a1	0.51			0.020		
B	1.39		1.65	0.055		0.065
b		0.5			0.020	
b1		0.25			0.010	
D			20			0.787
E		8.5			0.335	
e		2.54			0.100	
e3		15.24			0.600	
F			7.1			0.280
i			5.1			0.201
L		3.3			0.130	
Z	1.27		2.54	0.050		0.100

DIP14,TBL



**PACKAGE MECHANICAL DATA**  
14 PINS - PLASTIC MICROPACKAGE (SO)

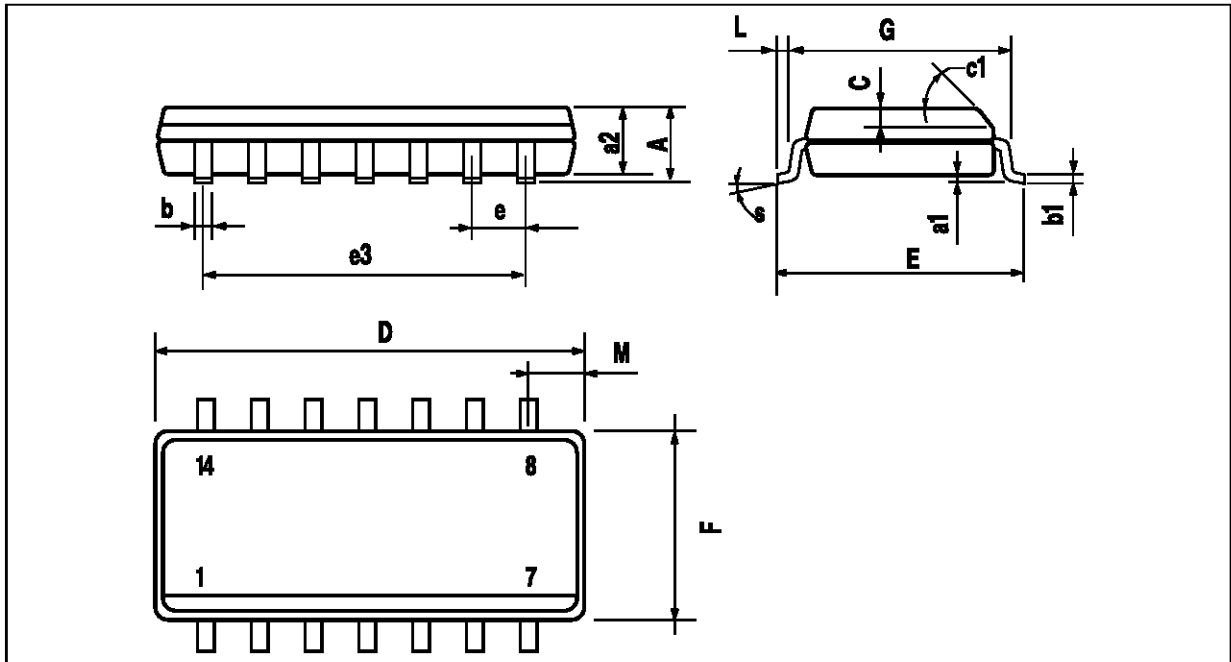

PM-SO14LEPS

Dimensions	Millimeters			Inches		
	Min.	Typ.	Max.	Min.	Typ.	Max.
A			1.75			0.069
a1	0.1		0.2	0.004		0.008
a2			1.6			0.063
b	0.35		0.46	0.014		0.018
b1	0.19		0.25	0.007		0.010
C		0.5			0.020	
c1	45° (typ.)					
D	8.55		8.75	0.336		0.334
E	5.8		6.2	0.228		0.244
e		1.27			0.050	
e3		7.62			0.300	
F	3.8		4.0	0.150		0.157
G	4.6		5.3	0.181		0.208
L	0.5		1.27	0.020		0.050
M			0.68			0.027
S	8° (max.)					

SO14.TBL

Information furnished is believed to be accurate and reliable. However, SGS-THOMSON Microelectronics assumes no responsibility for the consequences of use of such information nor for any infringement of patents or other rights of third parties which may result from its use. No license is granted by implication or otherwise under any patent or patent rights of SGS-THOMSON Microelectronics. Specification mentioned in this publication are subject to change without notice. This publication supersedes and replaces all information previously supplied. SGS-THOMSON Microelectronics products are not authorized for use as critical components in life support devices or systems without express written approval of SGS-THOMSON Microelectronics.

© 1997 SGS-THOMSON Microelectronics – Printed in Italy – All Rights Reserved

SGS-THOMSON Microelectronics GROUP OF COMPANIES  
Australia - Brazil - Canada - China - France - Germany - Hong Kong - Italy - Japan - Korea - Malaysia - Malta - Morocco  
The Netherlands - Singapore - Spain - Sweden - Switzerland - Taiwan - Thailand - United Kingdom - U.S.A.

ORDER CODE :