

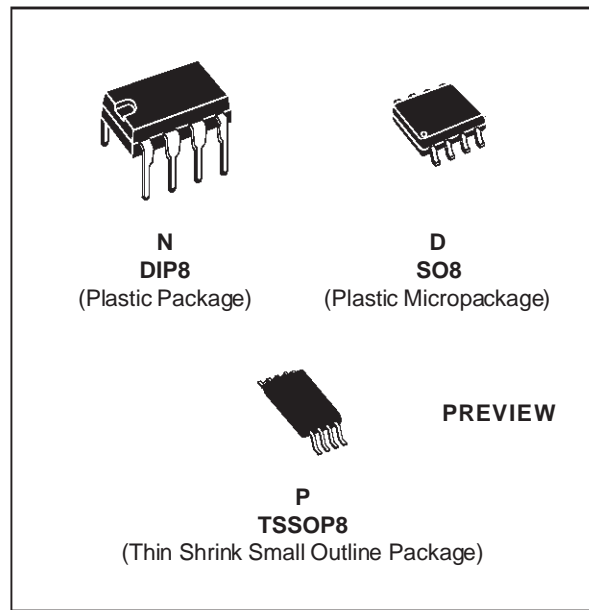

LM2904

LOW POWER DUAL OPERATIONAL AMPLIFIERS

- INTERNALLY FREQUENCY COMPENSATED
- LARGE DC VOLTAGE GAIN : 100dB
- WIDE BANDWIDTH (unity gain) : 1.1MHz (temperature compensated)
- VERY LOW SUPPLY CURRENT/OP (500 μ A) - ESSENTIALLY INDEPENDENT OF SUPPLY VOLTAGE
- LOW INPUT BIAS CURRENT : 20nA (temperature compensated)
- LOW INPUT OFFSET CURRENT : 2nA
- INPUT COMMON-MODE VOLTAGE RANGE INCLUDES GROUND
- DIFFERENTIAL INPUT VOLTAGE RANGE EQUAL TO THE POWER SUPPLY VOLTAGE
- LARGE OUTPUT VOLTAGE SWING 0V TO ($V_{CC} - 1.5V$)



DESCRIPTION

This circuit consists of two independent, high gain, internally frequency compensated which were designed specifically for automotive and industrial control system. It operates from a single power supply over a wide range of voltages. The low power supply drain is independent of the magnitude of the power supply voltage.

Application areas include transducer amplifiers, dc gain blocks and all the conventional op-amp circuits which now can be more easily implemented in single power supply systems. For example, these circuits can be directly supplied with off the standard + 5V which is used in logic systems and will easily provide the required interface electronics without requiring any additional power supply.

In the linear mode the input common-mode voltage range includes ground and the output voltage can also swing to ground, even though operated from only a single power supply voltage.

ORDER CODES

Part Number	Temperature Range	Package		
		N	D	P
LM2904	-40°C, +125°C	•	•	•

Example : LM2904D

PIN CONNECTIONS (top view)

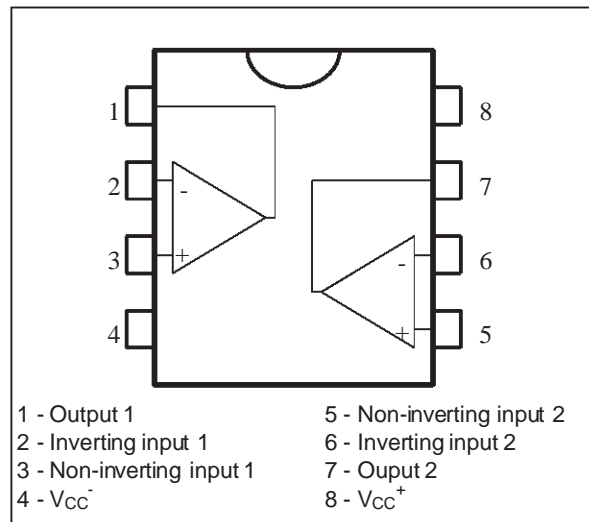

SCHMATIC DIAGRAM (1/2 LM2904)

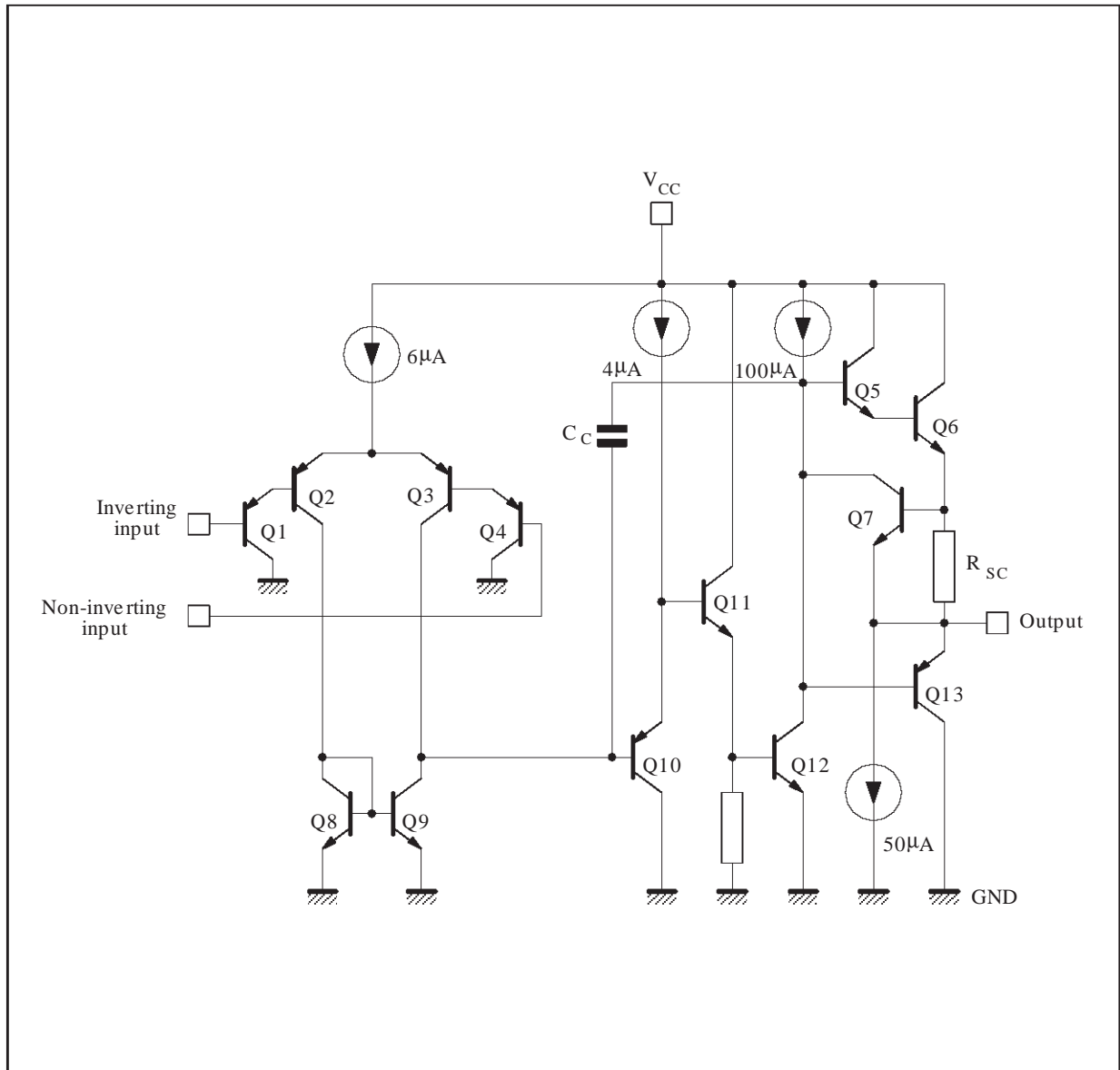

ABSOLUTE MAXIMUM RATINGS

Symbol	Parameter	LM2904	Unit
V _{CC}	Supply Voltage	+32	V
V _i	Input Voltage	-0.3 to +32	V
V _{id}	Differential Input Voltage	+32	V
	Output Short-circuit Duration - (note 2)		
P _{tot}	Power Dissipation	500	mW
I _{in}	Input Current - (note 1)	50	mA
T _{oper}	Operating Free-air Temperature Range	-40 to +125	°C
T _{stg}	Storage Temperature Range	-65 to +150	°C

ELECTRICAL CHARACTERISTICS
 $V_{CC}^+ = +5V$, $V_{CC}^- = \text{Ground}$, $V_O = 1.4V$, $T_{amb} = 25^\circ C$ (unless otherwise specified)

Symbol	Parameter	Min.	Typ.	Max.	Unit
V_{io}	Input Offset Voltage - (note 3) $T_{amb} = 25^\circ C$ $T_{min.} \leq T_{amb} \leq T_{max.}$		2	7 9	mV
I_{io}	Input Offset Current $T_{amb} = 25^\circ C$ $T_{min.} \leq T_{amb} \leq T_{max.}$		2	30 40	nA
I_{ib}	Input Bias Current - (note 4) $T_{amb} = 25^\circ C$ $T_{min.} \leq T_{amb} \leq T_{max.}$		20	150 200	nA
A_{vd}	Large Signal Voltage Gain ($V_{CC} = +15V$, $R_L = 2k\Omega$, $V_O = 1.4V$ to $11.4V$) $T_{amb} = 25^\circ C$ $T_{min.} \leq T_{amb} \leq T_{max.}$	50 25	100		V/mV
SVR	Supply Voltage Rejection Ratio ($R_S = 10k\Omega$) ($V_{CC}^+ = 5$ to $30V$) $T_{amb} = 25^\circ C$ $T_{min.} \leq T_{amb} \leq T_{max.}$	65 65	100		dB
I_{CC}	Supply Current, all Amp, no Load $V_{CC} = +5V$, $T_{min.} \leq T_{amb} \leq T_{max.}$ $V_{CC} = +30V$, $T_{min.} \leq T_{amb} \leq T_{max.}$		0.7	1.2 2	mA
V_{icm}	Input Common Mode Voltage Range ($V_{CC} = +30V$) - (note 6) $T_{amb} = 25^\circ C$ $T_{min.} \leq T_{amb} \leq T_{max.}$	0 0		$V_{CC}^+ - 1.5$ $V_{CC}^+ - 2$	V
CMR	Common-mode Rejection Ratio ($R_S = 10k\Omega$) $T_{amb} = 25^\circ C$ $T_{min.} \leq T_{amb} \leq T_{max.}$	70 60	85		dB
I_{source}	Output Source Current ($V_{CC} = +15V$, $V_O = 2V$, $V_{id} = +1V$)	20	40	60	mA
I_{sink}	Output Current Sink ($V_{id} = -1V$) $V_{CC} = +15V$, $V_O = 2V$ $V_{CC} = +15V$, $V_O = +0.2V$	10 12	20 50		mA μA
V_{OPP}	Output Voltage Swing ($R_L = 2k\Omega$) $T_{amb} = 25^\circ C$ $T_{min.} \leq T_{amb} \leq T_{max.}$	0 0		$V_{CC}^+ - 1.5$ $V_{CC}^+ - 2$	V
V_{OH}	High Level Output Voltage ($V_{CC}^+ = 30V$) $T_{amb} = 25^\circ C$ $R_L = 2k\Omega$ $T_{min.} \leq T_{amb} \leq T_{max.}$ $T_{amb} = 25^\circ C$ $R_L = 10k\Omega$ $T_{min.} \leq T_{amb} \leq T_{max.}$	26 26 27 27	27 28		V
V_{OL}	Low Level Output Voltage ($R_L = 10k\Omega$) $T_{amb} = 25^\circ C$ $T_{min.} \leq T_{amb} \leq T_{max.}$		5	20 20	mV
SR	Slew Rate ($V_{CC} = 15V$, $V_I = 0.5$ to $3V$, $R_L = 2k\Omega$, $C_L = 100pF$, unity gain)	0.3	0.6		V/ μs
GBP	Gain Bandwidth Product ($V_{CC} = 30V$, $f = 100kHz$, $V_{in} = 10mV$, $R_L = 2k\Omega$, $C_L = 100pF$)	0.7	1.1		MHz
THD	Total Harmonic Distortion ($f = 1kHz$, $A_v = 20dB$, $R_L = 2k\Omega$, $V_{CC} = 30V$, $C_L = 100pF$, $V_O = 2$ pp)		0.02		%

ELECTRICAL CHARACTERISTICS (continued)

Symbol	Parameter	Min.	Typ.	Max	Unit
DV_{io}	Input Offset Voltage Drift		7	30	$\mu A/^{\circ}C$
DI_{io}	Input Offset Current Drift		10	300	$pA/^{\circ}C$
V_{O1}/V_{O2}	Channel Separation (note 5) $1kHz \leq f \leq 20kHz$		120		dB

- Notes :
- This input current only exist when the voltage at any of the input leads is driven negative. It is due to the collector-base junction of the input PNP transistor becoming forward biased and thereby acting as input diode clamps. In addition to this diode action, there is also NPN parasitic action on the IC chip. This transistor action can cause the output voltages of the Op-amps to go to the V_{CC} voltage level (or to ground for a large overdrive) for the time duration that an input is driven negative. This is not destructive and normal output will set up again for input voltage higher than $-0.3V$.
 - Short-circuits from the output to V_{CC} can cause excessive heating if $V_{CC}^+ > 15V$. The maximum output current is approximately 40mA independent of the magnitude of V_{CC} . Destructive dissipation can result from simultaneous short-circuits on all amplifiers.
 - $V_O = 1.4V$, $R_s = 0\Omega$, $5V < V_{CC}^+ < 30V$, $0 < V_{ic} < V_{CC}^+ - 1.5V$.
 - The direction of the input current is out of the IC. This current is essentially constant, independent of the state of the output so no loading change exists on the input lines.
 - Due to the proximity of external components insure that coupling is not originating via stray capacitance between these external parts. This typically can be detected as this type of capacitance increases at higher frequencies.
 - The input common-mode voltage of either input signal voltage should not be allowed to go negative by more than 0.3V. The upper end of the common-mode voltage range is $V_{CC}^+ - 1.5V$. But either or both inputs can go to +32V without damage.

OPEN LOOP FREQUENCY RESPONSE (NOTE 3)

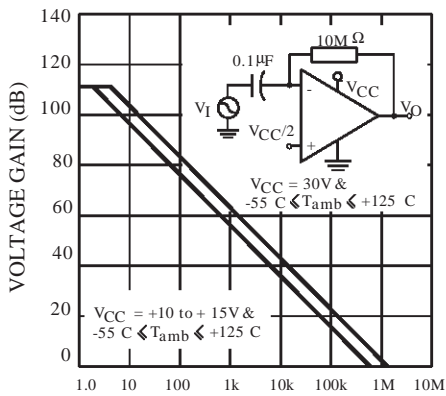

LARGE SIGNAL FREQUENCY RESPONSE

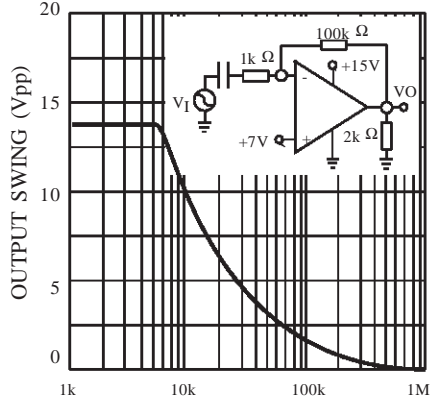

VOLAGE FOLLOWER PULSE RESPONSE

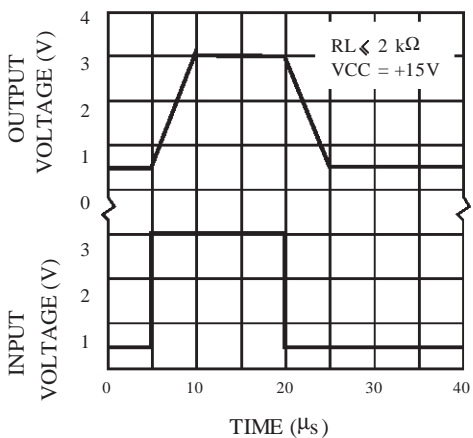

OUTPUT CHARACTERISTICS

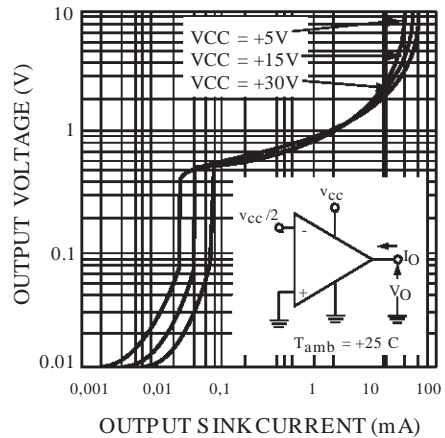

VOLTAGE FOLLOWER PULSE RESPONSE (SMALL SIGNAL)

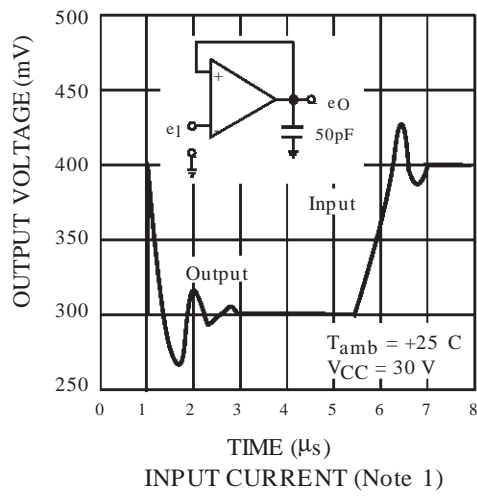

OUTPUT CHARACTERISTICS

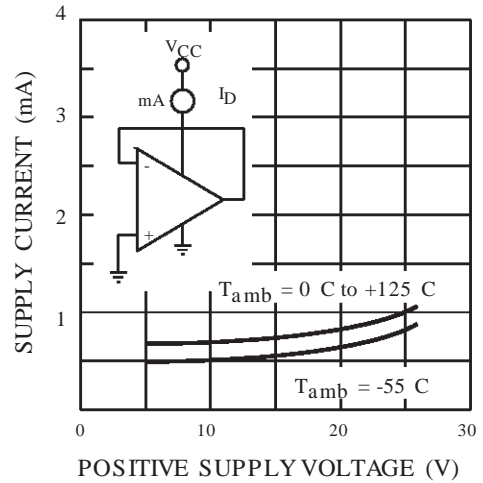
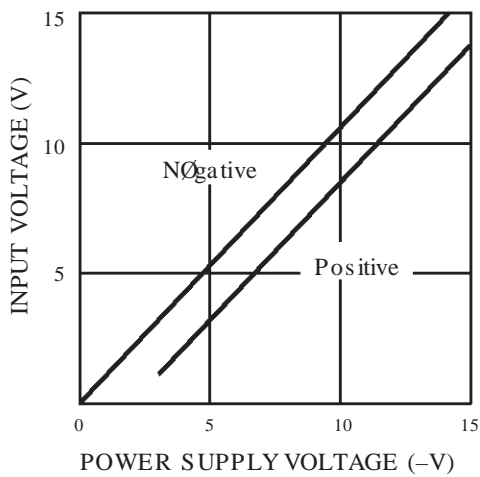
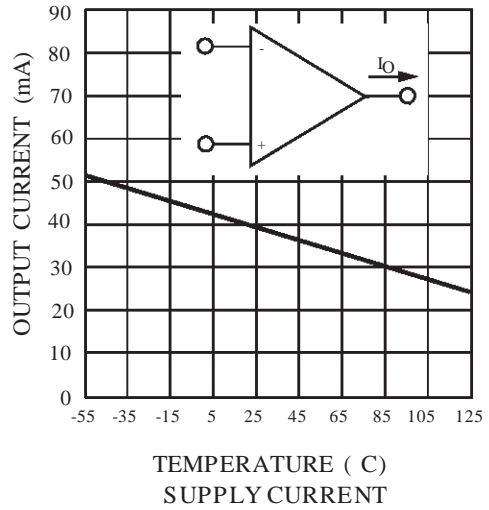
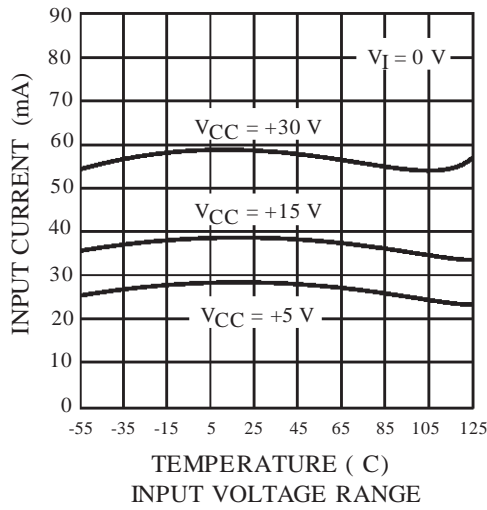
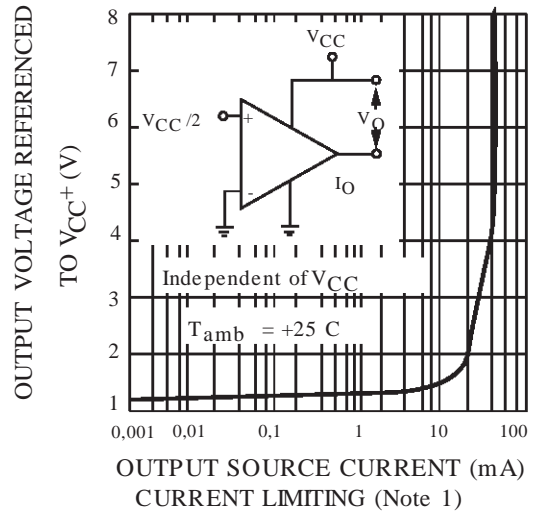

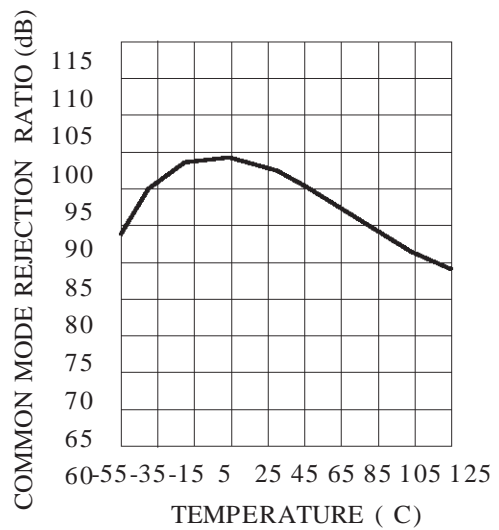
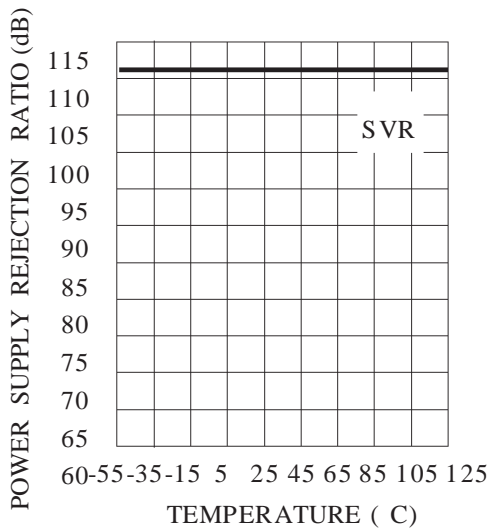
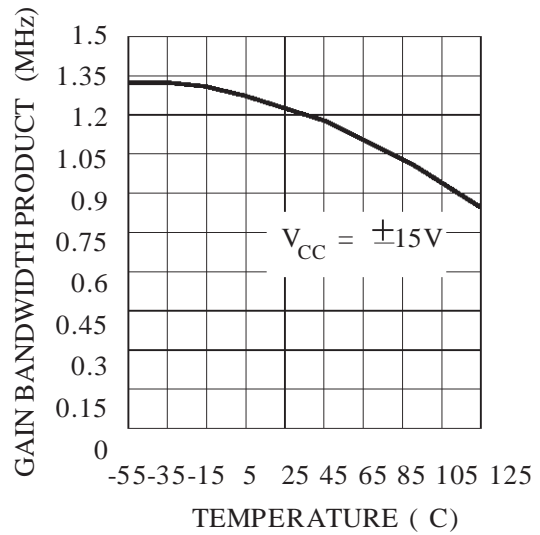
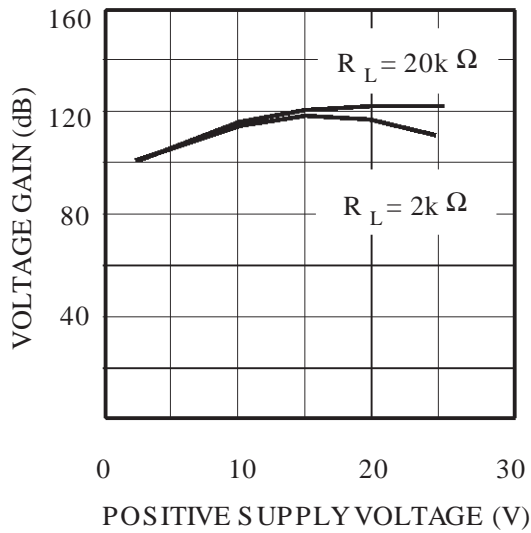
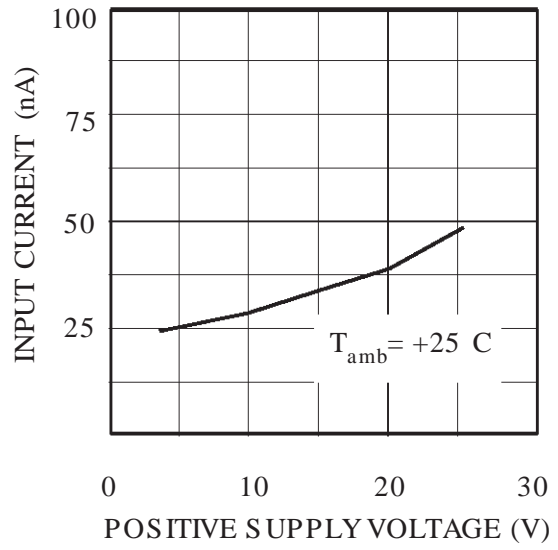
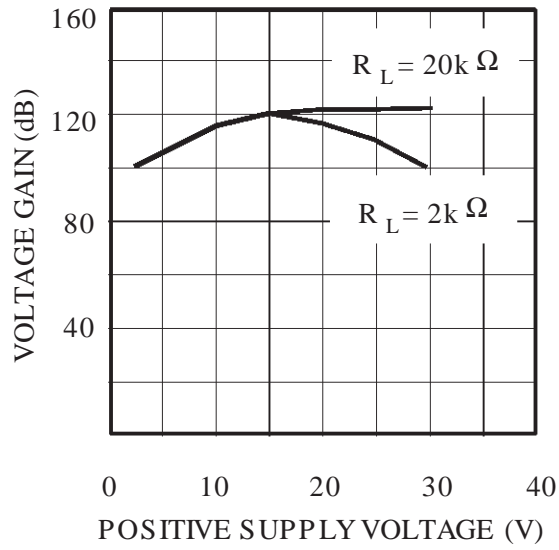

TYPICAL APPLICATIONS (single supply voltage) $V_{CC} = +5V_{DC}$

AC COUPLED INVERTING AMPLIFIER

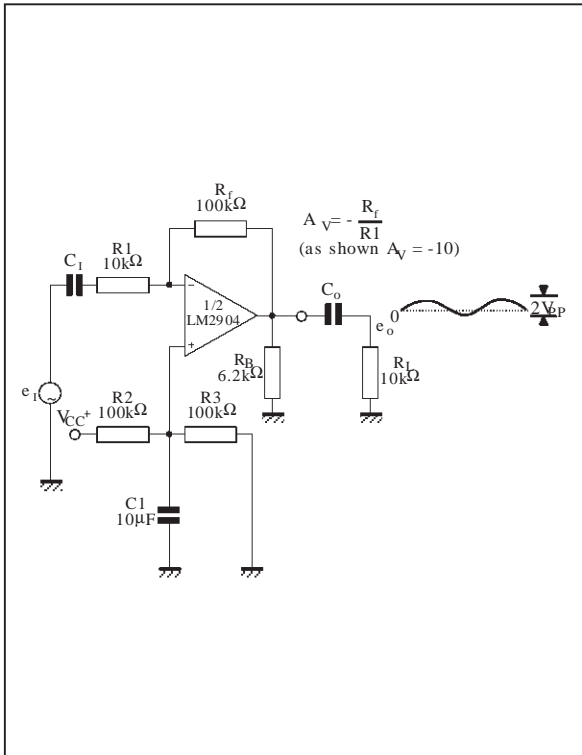

AC COUPLED NON-INVERTING AMPLIFIER

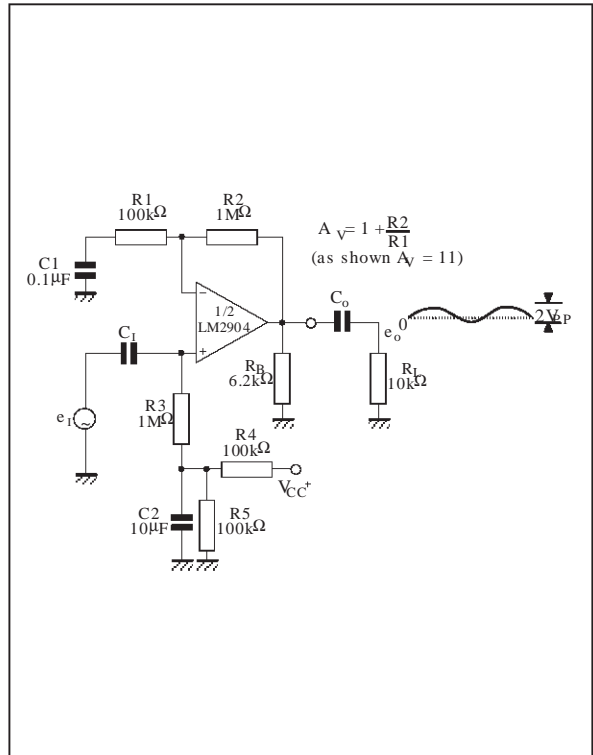

NON-INVERTING DC AMPLIFIER

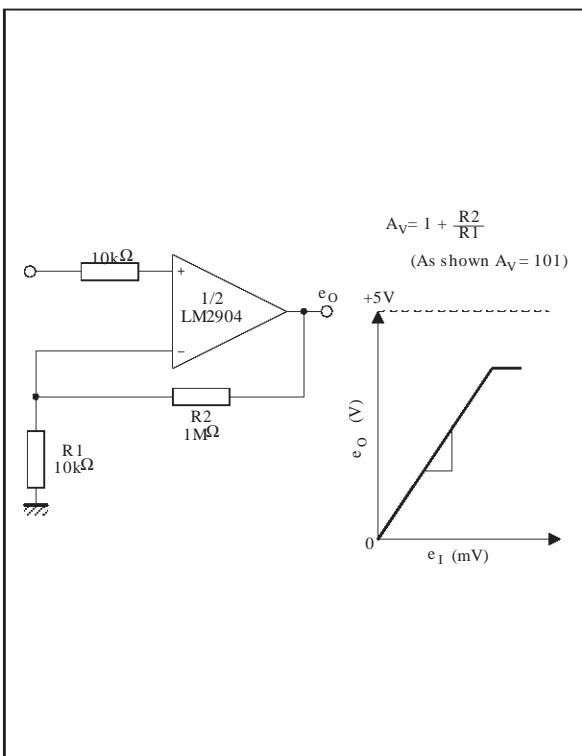

DC SUMMING AMPLIFIER

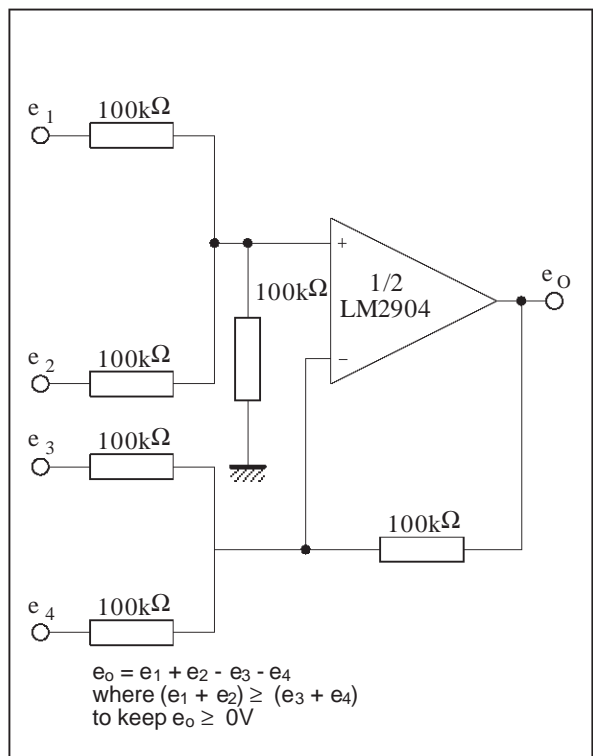

HIGH INPUT Z, DC DIFFERENTIAL AMPLIFIER

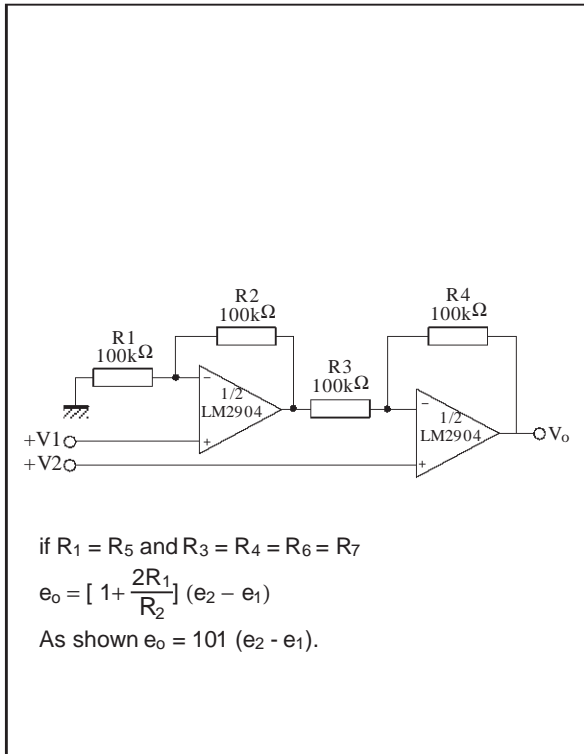

USING SYMMETRICAL AMPLIFIERS TO REDUCE INPUT CURRENT

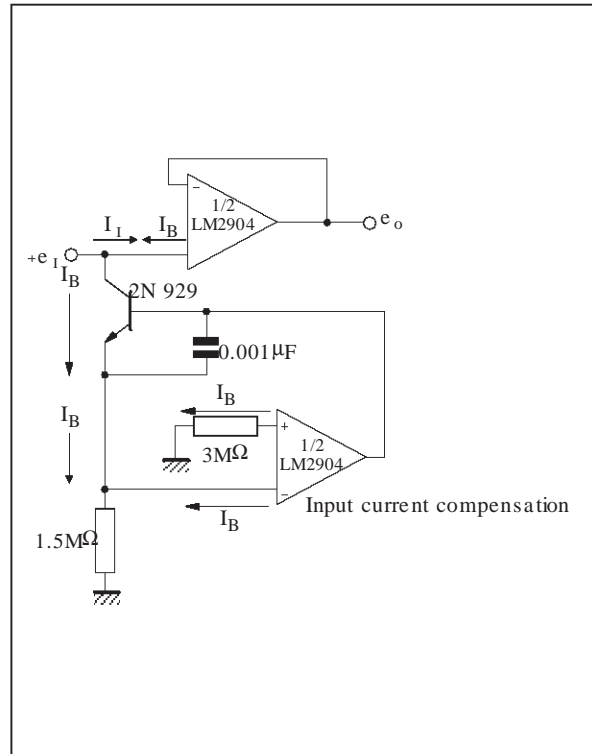

HIGH INPUT Z ADJUSTABLE GAIN DC INSTRUMENTATION AMPLIFIER

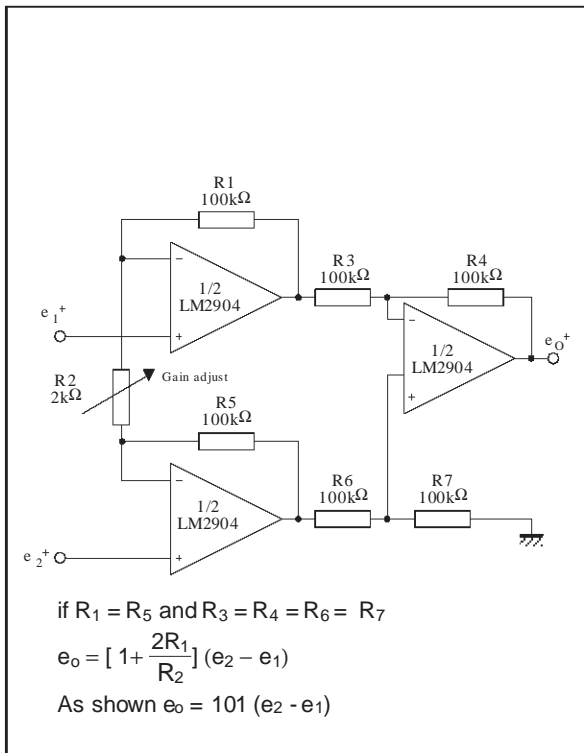

LOW DRIFT PEAK DETECTOR

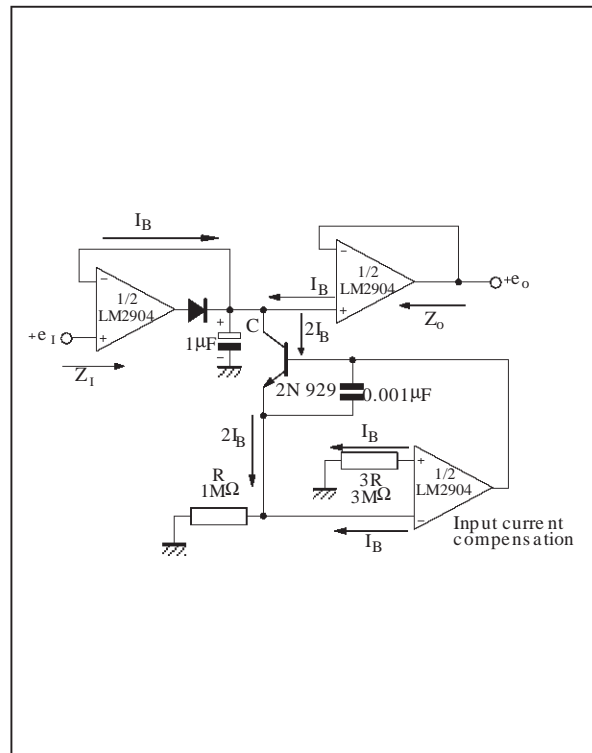

ACTIVE BAND-PASS FILTER

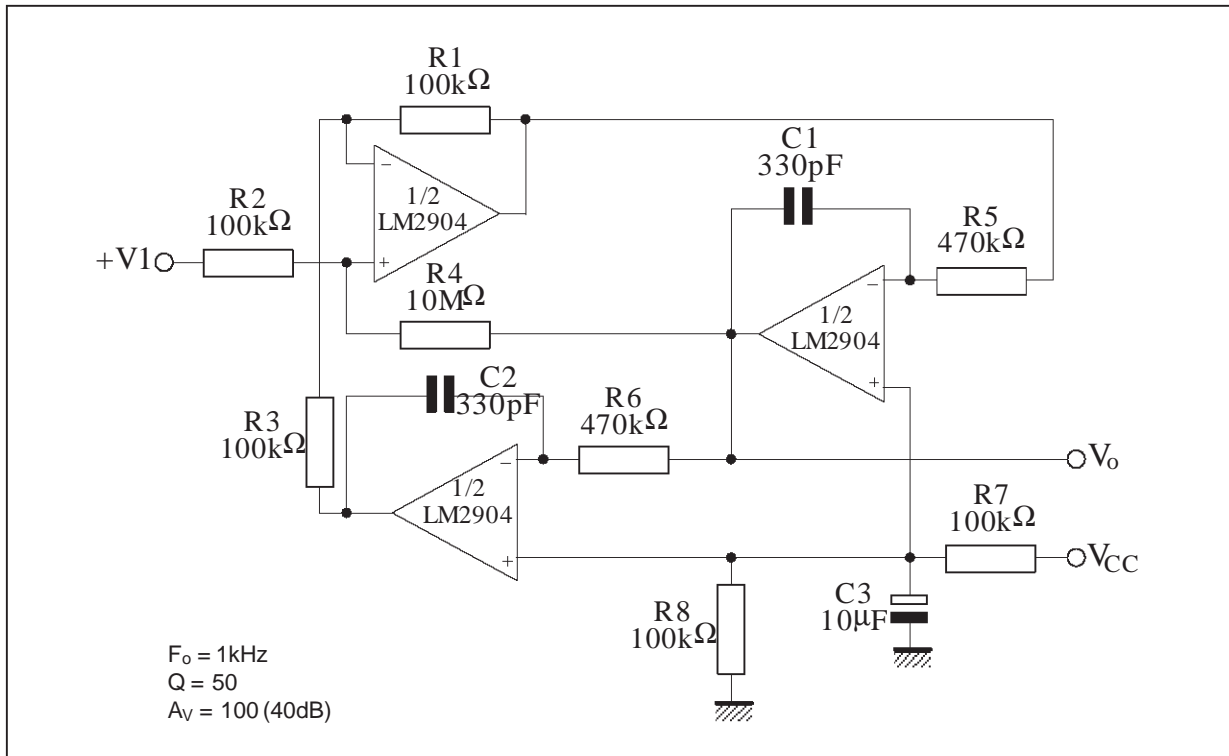

LM2904

PACKAGE MECHANICAL DATA 8 PINS - PLASTIC DIP

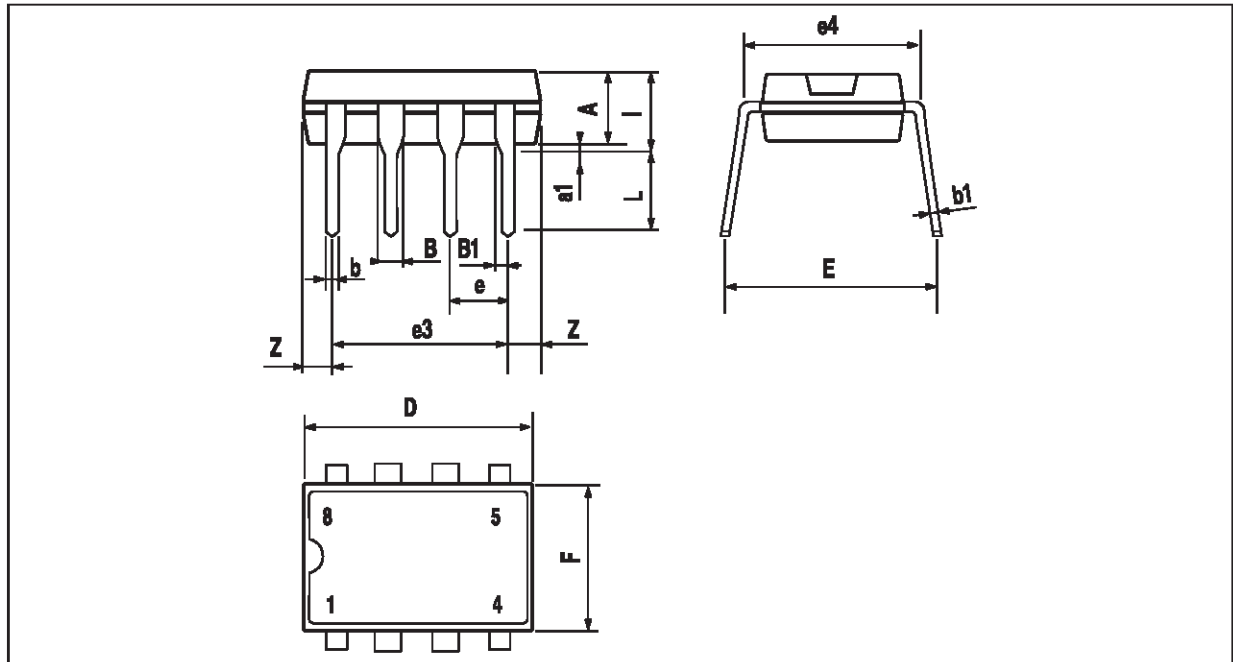

PM-DIP8.EPS

Dimensions	Millimeters			Inches		
	Min.	Typ.	Max.	Min.	Typ.	Max.
A		3.32			0.131	
a1	0.51			0.020		
B	1.15		1.65	0.045		0.065
b	0.356		0.55	0.014		0.022
b1	0.204		0.304	0.008		0.012
D			10.92			0.430
E	7.95		9.75	0.313		0.384
e		2.54			0.100	
e3		7.62			0.300	
e4		7.62			0.300	
F			6.6			0.260
i			5.08			0.200
L	3.18		3.81	0.125		0.150
Z			1.52			0.060

DIP8.TBL

PACKAGE MECHANICAL DATA
8 PINS - PLASTIC MICROPACKAGE (SO)

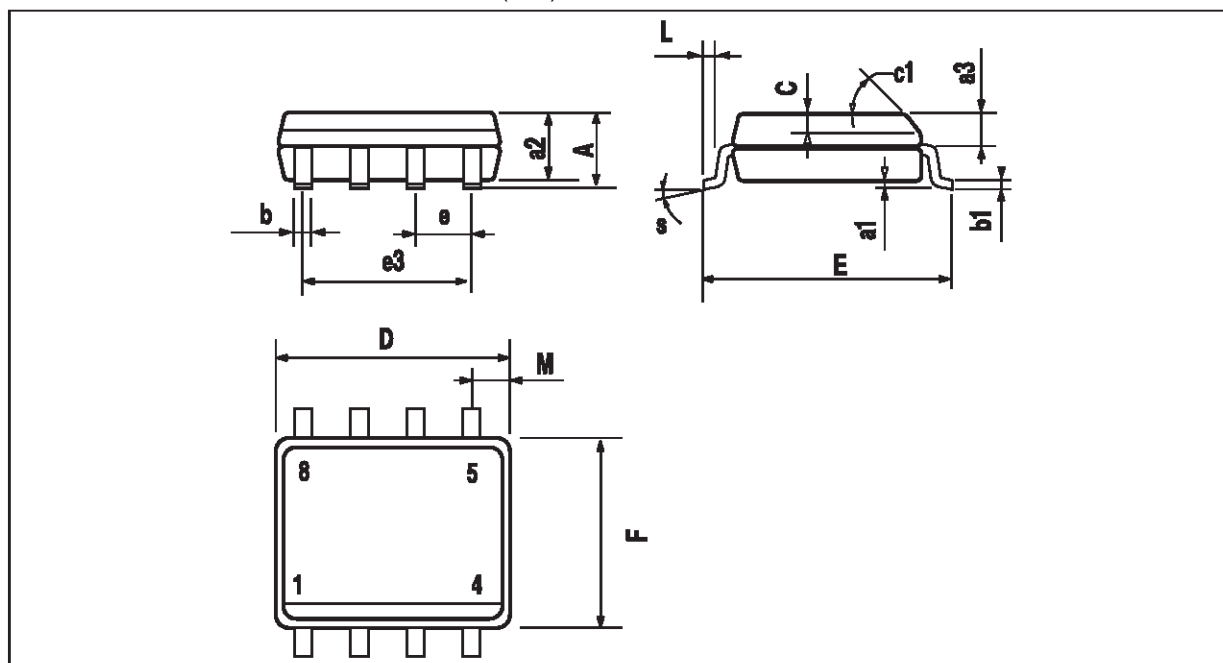

PM-SO8.EPS

Dimensions	Millimeters			Inches		
	Min.	Typ.	Max.	Min.	Typ.	Max.
A			1.75			0.069
a1	0.1		0.25	0.004		0.010
a2			1.65			0.065
a3	0.65		0.85	0.026		0.033
b	0.35		0.48	0.014		0.019
b1	0.19		0.25	0.007		0.010
C	0.25		0.5	0.010		0.020
c1	45° (typ.)					
D	4.8		5.0	0.189		0.197
E	5.8		6.2	0.228		0.244
e		1.27			0.050	
e3		3.81			0.150	
F	3.8		4.0	0.150		0.157
L	0.4		1.27	0.016		0.050
M			0.6			0.024
S	8° (max.)					

SO8.TBL

PACKAGE MECHANICAL DATA
8 PINS - THIN SHRINK SMALL OUTLINE PACKAGE

PREVIEW

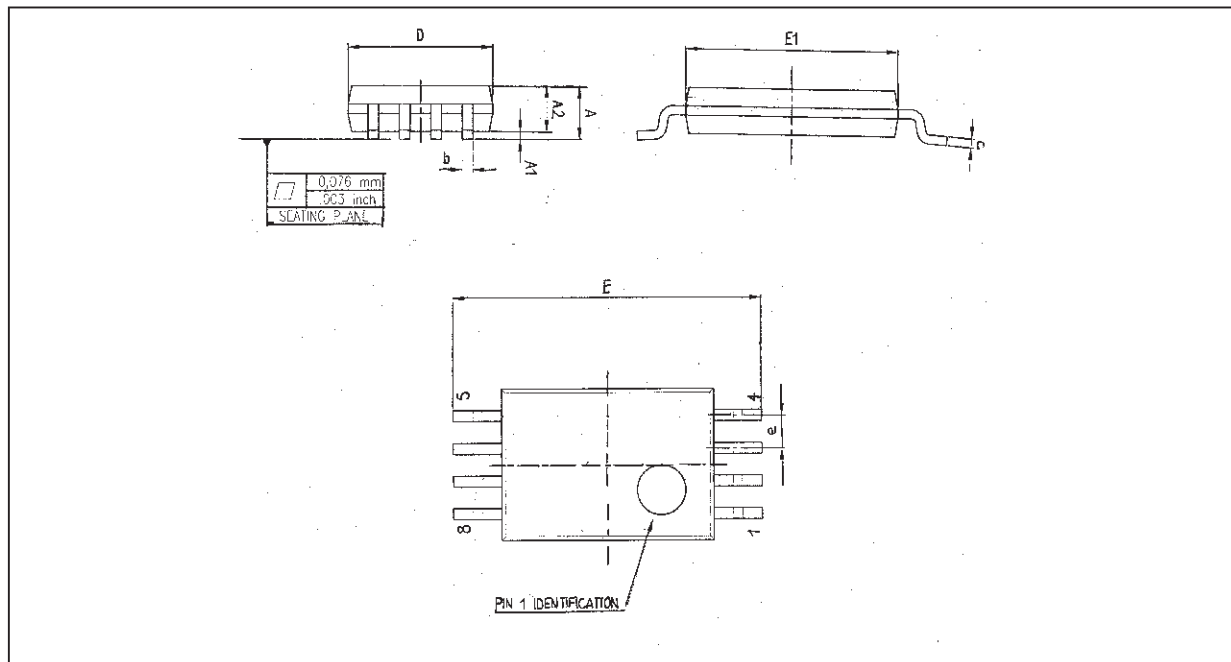

Dim.	Millimeters			Inches		
	Min.	Typ.	Max.	Min.	Typ.	Max.
A			1.20			0.05
A1	0.05		0.15	0.01		0.006
A2	0.80	1.00	1.05	0.031	0.039	0.041
b	0.19		0.30	0.007		0.15
c	0.09		0.20	0.003		0.012
D	2.90	3.00	3.10	0.114	0.118	0.122
E		6.40			0.252	
E1	4.30	4.40	4.50	0.169	0.173	0.177
e		0.65			0.025	
k	0°		8°	0°		8°
l	0.50	0.60	0.75	0.09	0.0236	0.030

Information furnished is believed to be accurate and reliable. However, STMicroelectronics assumes no responsibility for the consequences of use of such information nor for any infringement of patents or other rights of third parties which may result from its use. No license is granted by implication or otherwise under any patent or patent rights of STMicroelectronics. Specifications mentioned in this publication are subject to change without notice. This publication supersedes and replaces all information previously supplied. STMicroelectronics products are not authorized for use as critical components in life support devices or systems without express written approval of STMicroelectronics.

© The ST logo is a trademark of STMicroelectronics

© 1998 STMicroelectronics – Printed in Italy – All Rights Reserved
 STMicroelectronics GROUP OF COMPANIES

Australia - Brazil - Canada - China - France - Germany - Italy - Japan - Korea - Malaysia - Malta - Mexico - Morocco
 The Netherlands - Singapore - Spain - Sweden - Switzerland - Taiwan - Thailand - United Kingdom - U.S.A.

ORDER CODE:

