

SANYO

No.3379A

LC5732N**4-Bit Microcomputer with LCD Driver****Overview**

The LC5732N is a CMOS 4-bit microcomputer that operate on low voltage, very low current and contain LCD drivers. They also contain a 4-bit parallel processing ALU, a program memory ROM, many LCD segment outputs, a prescaler, an oscillator.

The LC5732N is especially suited for use in high-grade timepieces, time controllers, electronic calculators, LCD games with timepiece.

Hardware Features

- Supply voltage :
1.5V or 3.0V typ. (mask option-selectable)
- Very low current dissipation :
3.0 μ A typ. (Ag battery version, 32kHz crystal oscillation, during timekeeping operation)
1.5 μ A typ. (Li battery version, 32kHz crystal oscillation, during timekeeping operation)
- Crystal oscillator for timekeeping (32.768kHz crystal connected externally) or CR oscillator (CR connected externally)
- Many output pins for LCD panel drive (27 pins)

Drivable LCD panel		Number of drivable LCD segments
1/2 bias	1/3 duty	81 segments
1/2 bias	1/2 duty	54 segments
Static		27 segments
- On-chip melody function : 3 octaves (The melody length is software-controlled. One musical note requires one byte.)
- Input/output pins
 - Input pins : 8 pins
 - Control output pins : 3 pins (Output dedicated to alarm : 2 pins, general-purpose output : 1 pin)
- Possible to use LCD panel drive output pins as output-only ports (mask option-selectable)
- ROM : 2048 \times 8 bits
- RAM : 48 \times 4 bits
- Cycle time : 122 μ sec. for 32.768kHz crystal
- On-chip step-up circuit/step-down circuit
- Shipping style : Chip

Software Features

- Powerful instruction set : 92 instructions
- Table read instruction
- 1-level subroutine nesting
- On-chip 15-bit divider for timekeeping (delivers an overflow signal every 32ms or 64ms/100ms/500ms when a 32.768kHz crystal is used.)
- HALT function

SANYO Electric Co., Ltd. Semiconductor Business Headquarters
TOKYO OFFICE Tokyo Bldg., 1-10, 1 Chome, Ueno, Taïto-ku, TOKYO, 110 JAPAN

Application Development Support System

- Evaluation chip (LC5797) is available for application development and the dedicated equipment is available as the application development tools.
- Tools for developing the LC5732N application programs
 - ① · MS-DOS machine
 - Cross Assembler : LC5732.EXE
 - Mask Option selections program : SU5732.EXE
 - ② · SDS-410 system
 - Cross-Assembler : LC5732.COM
 - Mask Option selections program : SU5732.COM
- EVA-510 + TB-5734 + DCB-1 (Rev 2.0V or greater) + Application evaluation board + LC5797
By connecting to the SDS-410 or MS-DOS machine, application development program data correction and debugging may be done.
- TB-5734 + DCB-1 (Rev 2.0V or greater) + Application evaluation board + LC5797
By using the EPROM (2732) with application development program data written in, mounting evaluation may be done.

- Note 1
- The application evaluation board is constructed by the user.
 - LEDs or LCDs may be used for display.
 - The EVA-510 is a modified version of the EVA-410 whose monitor ROM is replaced by the SCR-5734.
- Note 2
- Since the evaluation chip LC5797 and the LC5732N differ in RAM capacity, check the ROM capacity when developing or debugging programs.
 - LC5732N : 48 × 4 bits
 - LC5797 : 256 × 4 bits
 - If the DPH value on a program is other than 0, 1, 2, the LC5732N will malfunction in actual applications.
 - When developing programs, take care of the DPH value. The usable DPH values are "0", "1", "2" only.
 - We will be free from any blame even if you use DPH = other than 0 to 2 to develop programs.
 - User's Manual : "LC5732/32H, 5733/33H, 5734/34H User's Manual"
Refer to the LC5732 section of this User's Manual.
 - Development Tool Manual : "LC5730 Series Development Tool Manual"
Refer to the LC5732 section of this Development Tool Manual.

Equivalent Circuit Block Diagram

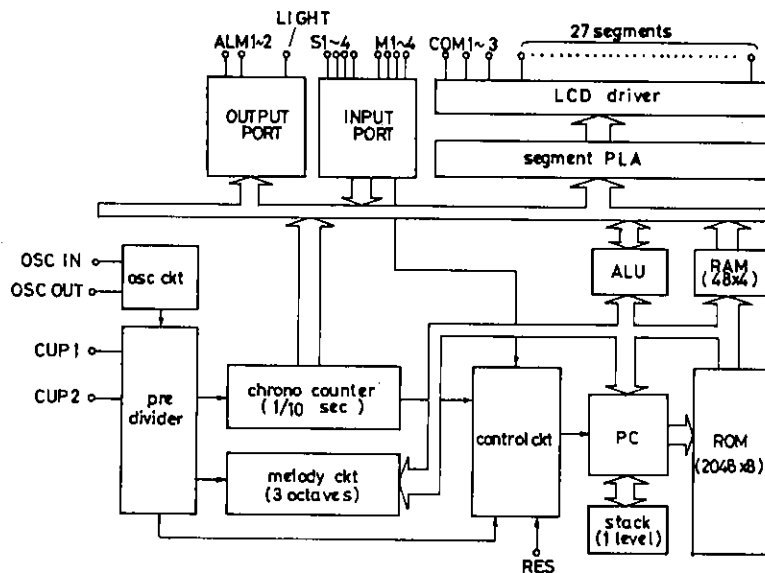

LC5732N

Pad Assignment of LSI Chip

Chip size : 3.72mm×3.11mm
 Chip thickness : 480μm
 Pad size : 120μm×120μm

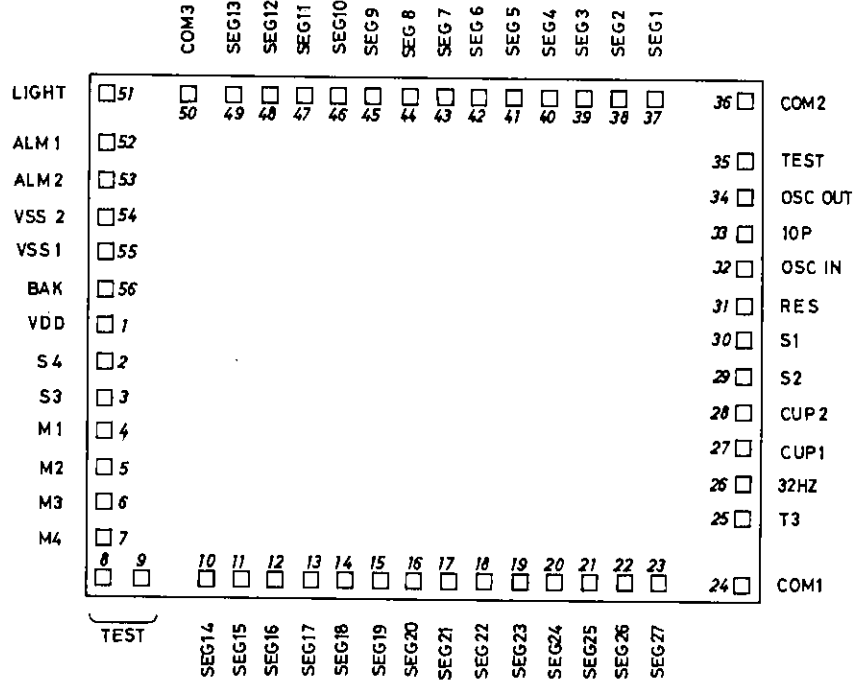

(Note) SEG14 to SEG27 can be used for output ports. (mask option-selectable)

Pad Name and Coordinates

Pad No	Pin Name	X (μm)	Y (μm)
1	VDD	-1665	90
2	S 4	-1665	-90
3	S 3	-1665	-295
4	M 1	-1665	-500
5	M 2	-1665	-700
6	M 3	-1665	-905
7	M 4	-1665	-1110
8	TEST	-1665	-1360
9	TEST	-1340	-1360
10	SEG14	-1100	-1360
11	SEG15	-920	-1360
12	SEG16	-740	-1360
13	SEG17	-560	-1360
14	SEG18	-380	-1360
15	SEG19	-200	-1360
16	SEG20	-20	-1360
17	SEG21	160	-1360
18	SEG22	340	-1360
19	SEG23	520	-1360
20	SEG24	700	-1360
21	SEG25	880	-1360
22	SEG26	1060	-1360
23	SEG27	1240	-1360
24	COM 1	1665	-1360
25	T 3	1665	-1075
26	32Hz	1665	-875
27	CUP 1	1665	-670
28	CUP 2	1665	-465

Pad No	Pin Name	X (μm)	Y (μm)
29	S 2	1665	-260
30	S 1	1665	-55
31	RES	1665	150
32	OSCIN	1665	410
33	10P	1665	635
34	OSCOUT	1665	840
35	TEST	1665	1045
36	COM 2	1665	1360
37	SEG 1	1150	1360
38	SEG 2	970	1360
39	SEG 3	790	1360
40	SEG 4	610	1360
41	SEG 5	430	1360
42	SEG 6	250	1360
43	SEG 7	70	1360
44	SEG 8	-110	1360
45	SEG 9	-290	1360
46	SEG10	-470	1360
47	SEG11	-650	1360
48	SEG12	-830	1360
49	SEG13	-1010	1360
50	COM 3	-1190	1360
51	LIGHT	-1665	1360
52	ALM 1	-1665	990
53	ALM 2	-1665	810
54	Vss 2	-1665	630
55	Vss 1	-1665	450
56	BAK	-1665	270

The pad coordinates are such that the chip center is taken as the origin and the values for (X, Y) represent the coordinates of the center point of each pad.

Pin Description

Pad No.	Pin Name	Input/Output	Circuit Configuration	Function
32	OSCIN	Input		<p>Crystal OSC mode 32.768kHz crystal is connected across OSCIN and OSCOUT for oscillation. Used as reference clock for timepiece and system clock.</p> <p>CR OSC mode R and C are connected across OSCIN and OSCOUT for oscillation. Used as system clock.</p>
34	OSCOUT	Output		<p>Connected to OSCOUT and used as OSC phase compensation capacitor.</p>
33	10P			<p>Connected to OSCOUT and used as OSC phase compensation capacitor.</p>

Continued on next page.

Continued from preceding page.

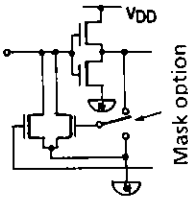
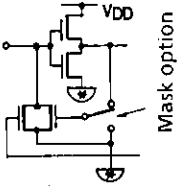
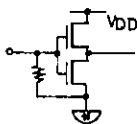
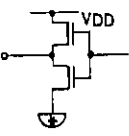
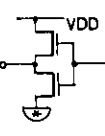
Pad No.	Pin Name	Input/Output	Circuit Configuration	Function																																		
30 29 3 2	S1 S2 S3 S4	Input		Input-only port. LSI system is reset by applying V _{DD} to S1 to S4 simultaneously. Note (Operating from Li battery, the RES pin must be used in both.)																																		
4 5 6 7	M1 M2 M3 M4	Input		Input pins for placing data in LSI.																																		
31	RES	Input		Input pin for resetting LSI system.																																		
56	BAK			(-) power supply pin for logic unit inside the LSI. For Li battery version, a capacitor must be connected across BAK and V _{DD} to prevent logic unit from malfunctioning.																																		
51	LIGHT	Output		Output-only pin Suited for driving transistor for light.																																		
52 53	ALM1 ALM2	Output		Output-only pin Used to deliver *4kHz, 2kHz, 1kHz modulation signal with instruction. Also used to deliver non-modulation signal. Used to deliver melody signal of 3 octaves with instruction.																																		
1	V _{DD}			(+) power supply pin.																																		
54 55	V _{SS2} V _{SS1}			(-) power supply pin. Ag battery version, Li battery version, EXT-V version : mask option selectable. Also used as power supply for LCD drive. The following Table shows how to connect external parts in each case.																																		
<table border="1" data-bbox="925 1769 1356 1926"> <thead> <tr> <th rowspan="2"></th> <th colspan="2">Ag bat. use</th> <th colspan="2">Li bat. use</th> <th colspan="2">EXT-V use</th> </tr> <tr> <th>static</th> <th>1/2 bias</th> <th>static</th> <th>1/2 bias</th> <th>static</th> <th>1/2 bias</th> </tr> </thead> <tbody> <tr> <td>V_{DD}</td> <td></td> <td></td> <td></td> <td></td> <td></td> <td></td> </tr> <tr> <td>V_{SS1}</td> <td></td> <td></td> <td></td> <td></td> <td></td> <td></td> </tr> <tr> <td>V_{SS2}</td> <td></td> <td></td> <td></td> <td></td> <td></td> <td></td> </tr> </tbody> </table>						Ag bat. use		Li bat. use		EXT-V use		static	1/2 bias	static	1/2 bias	static	1/2 bias	V _{DD}							V _{SS1}							V _{SS2}						
	Ag bat. use		Li bat. use			EXT-V use																																
	static	1/2 bias	static	1/2 bias	static	1/2 bias																																
V _{DD}																																						
V _{SS1}																																						
V _{SS2}																																						
27 28	CUP1 CUP2			Pins for connecting voltage step-up (step-down) capacitor.																																		

Continued on next page.

LC5732N

Continued from preceding page.

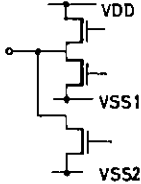
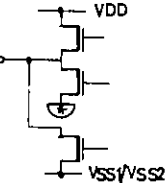
Pad No.	Pin Name	Input/Output	Circuit Configuration	Function																				
24 36 50	COM1 COM2 COM3	Output		<p>Output pins for LCD panel common plate. The following pin is used in each case.</p> <table border="1"> <thead> <tr> <th></th> <th>Static</th> <th>1/2 duty</th> <th>1/3 duty</th> </tr> </thead> <tbody> <tr> <td>COM1</td> <td>○</td> <td>○</td> <td>○</td> </tr> <tr> <td>COM2</td> <td>-</td> <td>○</td> <td>○</td> </tr> <tr> <td>COM3</td> <td>-</td> <td>-</td> <td>○</td> </tr> <tr> <td>Alternating frequency</td> <td>64Hz</td> <td>32Hz</td> <td>43Hz</td> </tr> </tbody> </table> <p>(Alternating frequency is for 32.768kHz crystal OSC application.)</p>		Static	1/2 duty	1/3 duty	COM1	○	○	○	COM2	-	○	○	COM3	-	-	○	Alternating frequency	64Hz	32Hz	43Hz
	Static	1/2 duty	1/3 duty																					
COM1	○	○	○																					
COM2	-	○	○																					
COM3	-	-	○																					
Alternating frequency	64Hz	32Hz	43Hz																					
10 to 23 37 to 49	Segment driver	Output		<p>Output pins for LCD panel segments. Mask option permits Seg 14 to Seg 27 (pad No.10 to 23) to be used as output ports.</p>																				
26 25 35 8 9	32Hz T3 TEST	Test		<p>Test pins (not used by user)</p>																				

(Note) For Ag battery power supply, \oplus is connected to V_{SS1}; for Li battery/EXT-V power supply, connected to V_{SS2}.

* 4kHz, 2kHz, 1kHz : For 32.768kHz crystal OSC application, proportional to OSC frequency.

Sample Application Circuits

(1) Ag Battery used application

(1/2 bias 1/3 duty) *: 4 segment outputs are used for output ports.

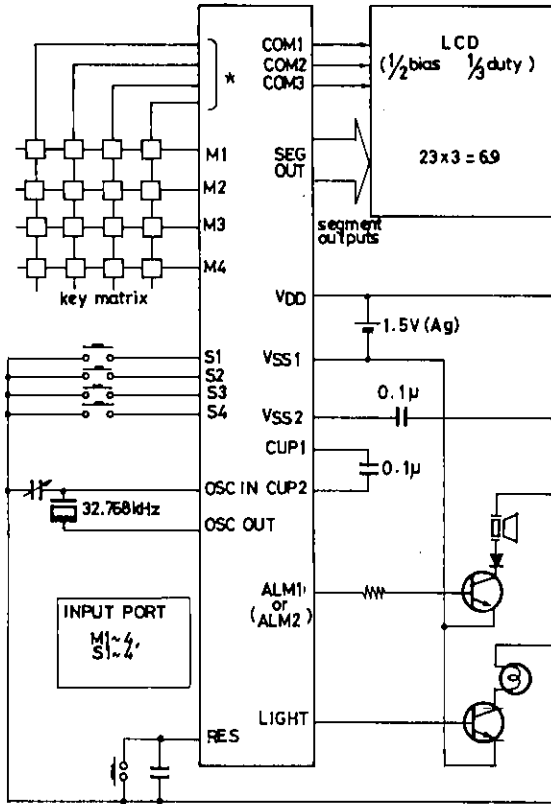

Crystal OSC (Power supply : Ag battery version)

(2) Li Battery used application

(1/2 bias 1/3 duty) *: 4 segment outputs are used for output ports.

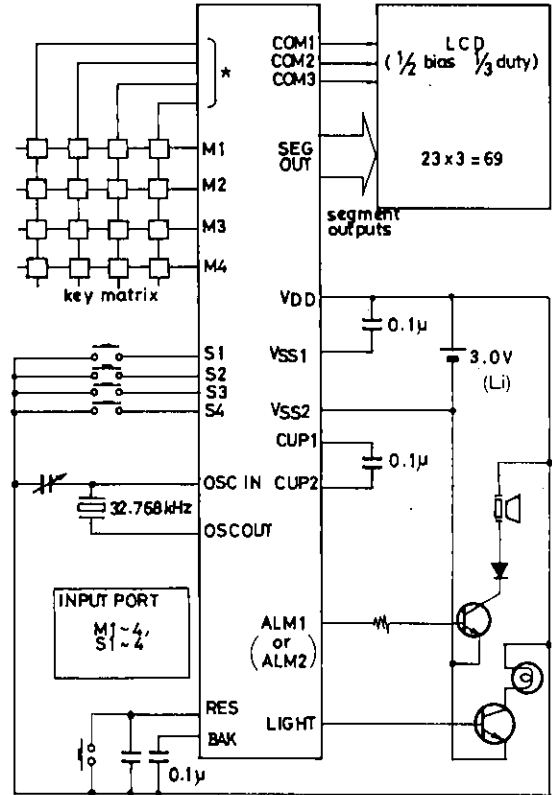

Crystal OSC (Power supply : Li battery version)

(3) EXT-V used application

(1/2 bias 1/3 duty) *: 4 segment outputs are used for output ports.

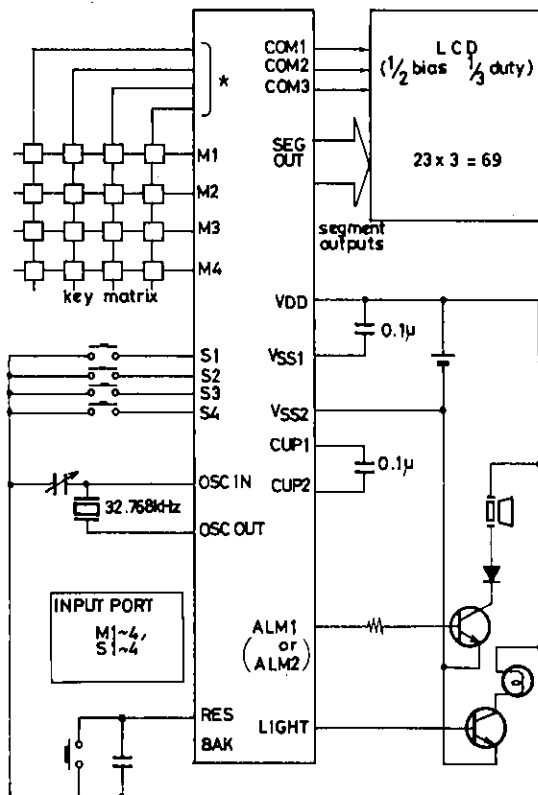

Crystal OSC (Power supply : EXT-V version)

Unit (capacitance: F)

LC5732N

● Ag Battery Version

Absolute Maximum Ratings at $T_a = 25 \pm 2^\circ\text{C}$, $V_{DD} = 0\text{V}$

				unit
Maximum Supply Voltage	V_{SS1}		-4.0 to +0.3	V
	V_{SS2}		-4.0 to +0.3	V
Maximum Input Voltage	V_{IN}	S1-4,M1-4,TEST,OSCIN,RES	$V_{SS1} - 0.3$ to +0.3	V
Maximum Output Voltage	V_{OUT1}	CUP2,OSCOUT,ALM1,ALM2,LIGHT	$V_{SS1} - 0.3$ to +0.3	V
	V_{OUT2}	SEGOUT,COM1,COM2,COM3,CUP1	$V_{SS2} - 0.3$ to +0.3	V
Operating Temperature	T_{opr}		-10 to +65	$^\circ\text{C}$
Storage Temperature	T_{stg}		-30 to +125	$^\circ\text{C}$

Allowable Operating Conditions at $T_a = 25 \pm 2^\circ\text{C}$, $V_{DD} = 0\text{V}$

			min	typ	max	unit
Supply Voltage	V_{SS1}		-1.65	-1.30		V
	V_{SS2}		-3.3	-2.4		V
Input 'H'-Level Voltage	V_{IH}	S1-4,M1-4,RES	-0.2	0		V
Input 'L'-Level Voltage	V_{IL}	S1-4,M1-4,RES	V_{SS1}	$V_{SS1} + 0.2$		V
Operating Frequency	f_{opg1}	$T_a = -10$ to $+65^\circ\text{C}$, crystal OSC (recommended OSC circuit Fig.7)	32		33	kHz
	f_{opg2}	$T_a = -10$ to $+65^\circ\text{C}$, CR OSC (recommended OSC circuit Fig.8)		32.768		kHz

(Recommended external CR constant : $C_{ext} = 33\text{pF}$, $R_{ext} = 510\text{k}\Omega$)

Electrical Characteristics at $T_a = 25 \pm 2^\circ\text{C}$, $V_{DD} = 0\text{V}$

			min	typ	max	unit
Input Resistance	R_{IN1A}	$V_{SS1} = -1.55\text{V}$, $V_{IL} = V_{SS1} + 0.2\text{V}$, 'L' level hold tr., *1, Fig.1	200		2000	k Ω
	R_{IN1B}	$V_{SS1} = -1.55\text{V}$, 'L' level pull-in tr., *1, Fig.1	200		2000	k Ω
	R_{IN2}	$V_{SS1} = -1.55\text{V}$, TEST, RES	10		300	k Ω
Output 'H'-Level Voltage	V_{OH1}	$V_{SS1} = -1.55\text{V}$, $I_{OH} = -0.4\mu\text{A}$, *2	-0.2			V
Output 'L'-Level Voltage	V_{OL1}	$V_{SS1} = -1.55\text{V}$, $I_{OL} = 0.4\mu\text{A}$, *2		$V_{SS2} + 0.2$		V
Output 'H'-Level Voltage	V_{OH2}	$V_{SS1} = -1.55\text{V}$, $I_{OH} = -4\mu\text{A}$, COM1, COM2, COM3	-0.2			V
Output 'M'-Level Voltage	V_{OM}	$V_{SS1} = -1.55\text{V}$, $I_{OH} = -4\mu\text{A}$, $I_{OL} = 4\mu\text{A}$, COM1, COM2, COM3	$V_{SS1} - 0.2$	$V_{SS1} + 0.2$		V
Output 'L'-Level Voltage	V_{OL2}	$V_{SS1} = -1.55\text{V}$, $I_{OL} = 4\mu\text{A}$, COM1, COM2, COM3		$V_{SS2} + 0.2$		V
Output 'H'-Level Voltage	V_{OH3}	$V_{SS1} = -1.35\text{V}$, $I_{OH} = -250\mu\text{A}$, ALM1, ALM2, LIGHT	-0.65			V
Output 'L'-Level Voltage	V_{OL3}	$V_{SS1} = -1.35\text{V}$, $I_{OL} = 150\mu\text{A}$, ALM1, ALM2, LIGHT		$V_{SS1} + 0.65$		V
Output 'H'-Level Voltage	V_{OH4}	$V_{SS1} = -1.55\text{V}$, $I_{OH} = -20\mu\text{A}$, *3	-0.2			V
Output 'L'-Level Voltage	V_{OL4}	$V_{SS1} = -1.55\text{V}$, $I_{OL} = 20\mu\text{A}$, *3		$V_{SS1} + 0.2$		V
Output Voltage	V_{SS2}	$V_{SS1} = -1.35\text{V}$, $C1 = C2 = 0.1\mu\text{F}$, $f_{opg} = 32.768\text{kHz}$, Fig.2	-3.3		-2.5	V
Current Dissipation	I_{DD1}	$V_{SS1} = -1.55\text{V}$, $C1 = C2 = 0.1\mu\text{F}$, $C_g = 20\text{pF}$, crystal OSC ($C_I \leq 25\text{k}\Omega$), Fig.2, backup flag OFF	HALT mode		2.0	μA
	I_{DD2}		ROM continue mode		5.0	μA
Oscillation Start Voltage	V_{stt}	$C_g = 20\text{pF}$, crystal OSC ($C_I \leq 25\text{k}\Omega$), Fig.3	-1.35			V
Oscillation Hold Voltage	V_{HOLD}	$C_g = 20\text{pF}$, crystal OSC ($C_I \leq 25\text{k}\Omega$), Fig.3		-1.30		V
Oscillation Start Time	t_{stt}	$V_{SS1} = -1.35\text{V}$, $C_g = 20\text{pF}$, crystal OSC ($C_I \leq 25\text{k}\Omega$), Fig.3			10	s
Oscillation Compensation Capacitance	10P	External pin	8	10	12	pF

LC5732N

● Li Battery Version

Absolute Maximum Ratings at $T_a = 25 \pm 2^\circ\text{C}, V_{DD} = 0\text{V}$

				unit
Maximum Supply Voltage	V_{SS1}		-4.0 to +0.3	V
	V_{SS2}		-4.0 to +0.3	V
Maximum Input Voltage	V_{IN1}	OSCIN	$V_{SS1} - 0.3$ to +0.3	V
	V_{IN2}	S1-4, M1-4, TEST, RES	$V_{SS2} - 0.3$ to +0.3	V
Maximum Output Voltage	V_{OUT1}	CUP2, OSCOUT	$V_{SS1} - 0.3$ to +0.3	V
	V_{OUT2}	SEGOUT, COM1, COM2, COM3, CUP1, LIGHT, ALM1, ALM2	$V_{SS2} - 0.3$ to +0.3	V
Operating Temperature	T_{opr}		-10 to +65	$^\circ\text{C}$
Storage Temperature	T_{stg}		-30 to +125	$^\circ\text{C}$

Allowable Operating Conditions at $T_a = 25 \pm 2^\circ\text{C}, V_{DD} = 0\text{V}$

			min	typ	max	unit
Supply Voltage	V_{SS1}		-3.6	-1.3		V
	V_{SS2}		-3.6	-2.0		V
Input 'H'-Level Voltage	V_{IH}	S1-4, M1-4, RES	-0.4	0		V
Input 'L'-Level Voltage	V_{IL}	S1-4, M1-4, RES	V_{SS2}	$V_{SS2} + 0.4$		V
Operating Frequency	f_{opg1}	$T_a = -10$ to $+65^\circ\text{C}$, crystal OSC (recommended OSC circuit Fig.7)	32		33	kHz

Electrical Characteristics at $T_a = 25 \pm 2^\circ\text{C}, V_{DD} = 0\text{V}$

			min	typ	max	unit
Input Resistance	R_{IN1A}	$V_{SS2} = -2.9\text{V}, V_{IL} = V_{SS2} + 0.4\text{V}$, 'L' level hold tr., *1, Fig.4	200		2000	k Ω
	R_{IN1B}	$V_{SS2} = -2.9\text{V}$, 'L' level pull-in tr., *1, Fig.4	100		2000	k Ω
	R_{IN2}	$V_{SS2} = -2.9\text{V}, \text{TEST, RES}$	10		300	k Ω
Output 'H'-Level Voltage	V_{OH1}	$V_{SS2} = -2.9\text{V}, I_{OH} = -0.4\mu\text{A}$, *2	-0.2			V
Output 'L'-Level Voltage	V_{OL1}	$V_{SS2} = -2.9\text{V}, I_{OL} = 0.4\mu\text{A}$, *2		$V_{SS2} + 0.2$		V
Output 'H'-Level Voltage	V_{OH2}	$V_{SS2} = -2.9\text{V}, I_{OH} = -4\mu\text{A}$, COM1, COM2, COM3	-0.2			V
Output 'M'-Level Voltage	V_{OM}	$V_{SS2} = -2.9\text{V}, I_{OH} = -4\mu\text{A}$, $I_{OL} = 4\mu\text{A}$, COM1, COM2, COM3	$V_{SS2}/2 - 0.2$	$V_{SS2}/2 + 0.2$		V
Output 'L'-Level Voltage	V_{OL2}	$V_{SS2} = -2.9\text{V}, I_{OL} = 4\mu\text{A}$, COM1, COM2, COM3		$V_{SS2} + 0.2$		V
Output 'H'-Level Voltage	V_{OH3}	$V_{SS2} = -2.4\text{V}, I_{OH} = -250\mu\text{A}$, ALM1, ALM2	-0.65			V
Output 'L'-Level Voltage	V_{OL3}	$V_{SS2} = -2.4\text{V}, I_{OL} = 250\mu\text{A}$, ALM1, ALM2		$V_{SS2} + 0.65$		V
Output 'H'-Level Voltage	V_{OH4}	$V_{SS2} = -2.4\text{V}, I_{OH} = -150\mu\text{A}$, LIGHT	-1.5			V
Output 'L'-Level Voltage	V_{OL4}	$V_{SS2} = -2.4\text{V}, I_{OL} = 150\mu\text{A}$, LIGHT		$V_{SS2} + 1.5$		V
Output 'H'-Level Voltage	V_{OH5}	$V_{SS2} = -2.9\text{V}, I_{OH} = -40\mu\text{A}$, *3	-0.4			V
Output 'L'-Level Voltage	V_{OL5}	$V_{SS2} = -2.9\text{V}, I_{OL} = 40\mu\text{A}$, *3		$V_{SS2} + 0.4$		V
Output Voltage (halver)	V_{SS1}	$V_{SS2} = -2.8\text{V}$, $C1 = C2 = 0.1\mu\text{F}, f_{opg} = 32.768\text{kHz}$, Fig.5		-1.35		V
Current Dissipation	I_{DD1}	$V_{SS2} = -2.9\text{V}, C1 = C2 = 0.1\mu\text{F}$, crystal OSC] HALT mode		0.8		μA
	I_{DD2}	($C1 \leq 25\text{k}\Omega$), $Cg = 20\text{pF}$, Fig.5, backup flag OFF] ROM continue mode		2.0		μA
Oscillation Start Voltage	V_{stt}	$Cg = 20\text{pF}$, crystal OSC ($C1 \leq 25\text{k}\Omega$), Fig.6	-1.35			V
Oscillation Hold Voltage	V_{HOLD}	$Cg = 20\text{pF}$, crystal OSC ($C1 \leq 25\text{k}\Omega$), Fig.6		-1.3		V
Oscillation Start Time	t_{stt}	$V_{SS2} = -1.35\text{V}, Cg = 20\text{pF}$, crystal OSC ($C1 \leq 25\text{k}\Omega$), Fig.6			10	s
Oscillation Compensation Capacitance	10P	External pin	8	10	12	pF

LC5732N

● EXT-V Version

Absolute Maximum Ratings at $T_a = 25 \pm 2^\circ\text{C}$, $V_{DD} = 0\text{V}$

			unit
Maximum Supply Voltage	V_{SS1}	-4.0 to +0.3	V
	V_{SS2}	-4.0 to +0.3	V
Maximum Input Voltage	V_{IN}	OSCIN, S1-4,M1-4,TEST,RES	$V_{SS2} - 0.3$ to +0.3 V
Maximum Output Voltage	V_{OUT}	CUP2,OSCOUT, SEGOUT,COM1,COM2,COM3,CUP1, LIGHT,ALM1,ALM2	$V_{SS2} - 0.3$ to +0.3 V
Operating Temperature	T_{opr}		-30 to +70 °C
Storage Temperature	T_{stg}		-40 to +125 °C

Allowable Operating Conditions at $T_a = 25 \pm 2^\circ\text{C}$, $V_{DD} = 0\text{V}$

			min	typ	max	unit
Supply Voltage	V_{SS1}		-3.6	-1.3		V
	V_{SS2}		-3.6	-2.0		V
Input 'H'-Level Voltage	V_{IH}	S1-4,M1-4,RES	-0.4	0		V
Input 'L'-Level Voltage	V_{IL}	S1-4,M1-4,RES	V_{SS2}	$V_{SS2} + 0.4$		V
Operating Frequency	f_{opg1}	$T_a = -30$ to $+70^\circ\text{C}$, crystal OSC (recom- mended OSC circuit Fig.7)	32		33	kHz
	f_{opg2}	$T_a = -30$ to $+70^\circ\text{C}$, CR OSC (recom- mended OSC circuit Fig.8)		32.768		kHz
(Recommended external CR constant : $C = 27\text{pF}$, $R = 680\text{k}\Omega$)						

Electrical Characteristics at $T_a = 25 \pm 2^\circ\text{C}$, $V_{DD} = 0\text{V}$

			min	typ	max	unit
Input Resistance	R_{IN1A}	$V_{SS2} = -2.9\text{V}$, $V_{IL} = V_{SS2} + 0.4\text{V}$, 'L' level hold tr., *1, Fig.4	200		2000	k Ω
	R_{IN1B}	$V_{SS2} = -2.9\text{V}$, 'L' level pull-in tr., *1, Fig.4	100		2000	k Ω
	R_{IN2}	$V_{SS2} = -2.9\text{V}$, TEST, RES	10		300	k Ω
Output 'H'-Level Voltage	V_{OH1}	$V_{SS2} = -2.9\text{V}$, $I_{OH} = -0.4\mu\text{A}$, *2	-0.2			V
Output 'L'-Level Voltage	V_{OL1}	$V_{SS2} = -2.9\text{V}$, $I_{OL} = 0.4\mu\text{A}$, *2			$V_{SS2} + 0.2$	V
Output 'H'-Level Voltage	V_{OH2}	$V_{SS2} = -2.9\text{V}$, $I_{OH} = -4\mu\text{A}$, COM1, COM2, COM3	-0.2			V
Output 'M'-Level Voltage	V_{OM}	$V_{SS2} = -2.9\text{V}$, $I_{OH} = -4\mu\text{A}$, $I_{OL} = 4\mu\text{A}$, COM1, COM2, COM3	$V_{SS2}/2 - 0.2$		$V_{SS2}/2 + 0.2$	V
Output 'L'-Level Voltage	V_{OL2}	$V_{SS2} = -2.9\text{V}$, $I_{OL} = 4\mu\text{A}$, COM1, COM2, COM3			$V_{SS2} + 0.2$	V
Output 'H'-Level Voltage	V_{OH3}	$V_{SS2} = -2.4\text{V}$, $I_{OH} = -250\mu\text{A}$, ALM1, ALM2	-0.65			V
Output 'L'-Level Voltage	V_{OL3}	$V_{SS2} = -2.4\text{V}$, $I_{OL} = 250\mu\text{A}$, ALM1, ALM2			$V_{SS2} + 0.65$	V
Output 'H'-Level Voltage	V_{OH4}	$V_{SS2} = -2.4\text{V}$, $I_{OH} = -150\mu\text{A}$, LIGHT	-1.5			V
Output 'L'-Level Voltage	V_{OL4}	$V_{SS2} = -2.4\text{V}$, $I_{OL} = 150\mu\text{A}$, LIGHT			$V_{SS2} + 1.5$	V
Output 'H'-Level Voltage	V_{OH5}	$V_{SS2} = -2.9\text{V}$, $I_{OH} = -40\mu\text{A}$, *3	-0.4			V
Output 'L'-Level Voltage	V_{OL5}	$V_{SS2} = -2.9\text{V}$, $I_{OL} = 40\mu\text{A}$, *3			$V_{SS2} + 0.4$	V
Output Voltage (halver)	V_{SS1}	$V_{SS2} = -2.8\text{V}$, $C1 = C2 = 0.1\mu\text{F}$, $f_{opg} = 32.768\text{kHz}$, Fig.5			-1.35	V
Current Dissipation	I_{DD1}	$V_{SS2} = -2.9\text{V}$, $C1 =$ $C2 = 0.1\mu\text{F}$, crystal OSC ($C_I \leq 25\text{k}\Omega$), $C_g = 20\text{pF}$, Fig.5	HALT mode		5.0	μA
	I_{DD2}		ROM continue mode		12.5	μA
Oscillation Start Voltage	V_{stt}	$C_g = 20\text{pF}$, crystal OSC ($C_I \leq 25\text{k}\Omega$), Fig.6	-2.2			V
Oscillation Hold Voltage	V_{HOLD}	$C_g = 20\text{pF}$, crystal OSC ($C_I \leq 25\text{k}\Omega$), Fig.6			-2.0	V

Continued on next page.

Continued from preceding page.

			min	typ	max	unit
Oscillation Start Time	t_{stt}	$V_{SS2} = -2.2V, C_g = 20pF,$ crystal OSC ($C_I \leq 25k\Omega$), Fig.6				10 sec
Oscillation Compensation Capacitance	10P	External pin	8	10	12	pF

- ※1 S1, S2, S3, S4 ; M1, M2, M3, M4
- ※2 LCD driver output pins out of SEGOUT14 to 27, SEGOUT1 to 13
- ※3 Output pins (used as output port) of SEGOUT14 to 27

Table 1 Constants Guaranteed for Crystal OSC

Oscillator Type	Supplier	Oscillator	Power Supply	Cg
32.768kHz crystal oscillation	Daiwa Shinku	DT-38, 32.768kHz (CL=12.5pF)	Ag/Li EXT-V	15pF
	Kyocera	KF-38G, 32.768kHz (CL=13pF)	Ag/Li	20pF
			EXT-V	18pF

Cg tolerance : $\pm 5\%$

(Note) Since the circuit pattern affects the oscillation frequency, place the oscillation-related parts as close to the oscillation pins as possible with the shortest possible pattern length.

If oscillators other than shown above are used, the characteristics cannot be guaranteed.

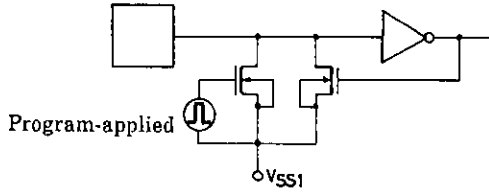

Fig.1 Input configuration of S1-4, M1-4

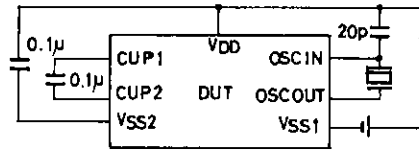

Fig.2 Current dissipation, output voltage test circuit

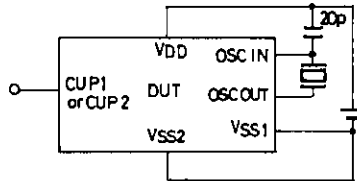

Fig.3 Oscillation start voltage, oscillation start time, frequency stability, oscillation hold voltage test circuit

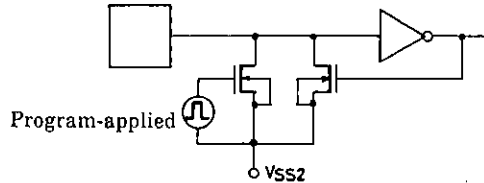

Fig.4 Input configuration of S1-4, M1-4

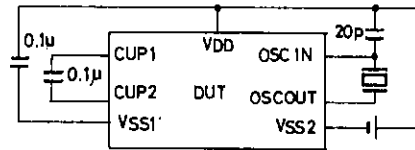

Fig.5 Current dissipation, output voltage test circuit

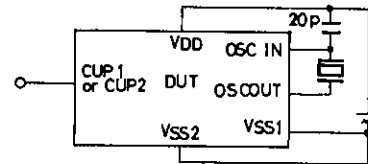

Fig.6 Oscillation start voltage, oscillation start time, frequency stability, oscillation hold voltage test circuit

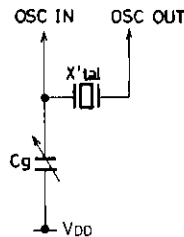

Fig.7 Recommended crystal oscillation circuit

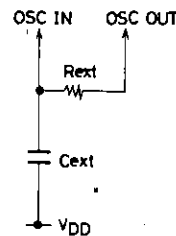

Fig.8 Recommended CR oscillation circuit

Unit (capacitance: F)

- No products described or contained herein are intended for use in surgical implants, life-support systems, aerospace equipment, nuclear power control systems, vehicles, disaster/crime-prevention equipment and the like, the failure of which may directly or indirectly cause injury, death or property loss.
- Anyone purchasing any products described or contained herein for an above-mentioned use shall:
 - ① Accept full responsibility and indemnify and defend SANYO ELECTRIC CO., LTD., its affiliates, subsidiaries and distributors and all their officers and employees, jointly and severally, against any and all claims and litigation and all damages, cost and expenses associated with such use;
 - ② Not impose any responsibility for any fault or negligence which may be cited in any such claim or litigation on SANYO ELECTRIC CO., LTD., its affiliates, subsidiaries and distributors or any of their officers and employees jointly or severally.
- Information (including circuit diagrams and circuit parameters) herein is for example only; it is not guaranteed for volume production. SANYO believes information herein is accurate and reliable, but no guarantees are made or implied regarding its use or any infringements of intellectual property rights or other rights of third parties.