

<b>SANYO</b>	No.4794B	<b>LC3564S, SS, SM, ST-70/85/10</b>
		<b>64K (8192words×8 bits)SRAM</b>

### Overview

The LC3564S, LC3564SS, LC3564SM, and LC3564ST are asynchronous silicon gate CMOS static RAMs with an 8192-word X 8-bit organization. These SRAMs are full CMOS type SRAMs with a six-transistor memory cell and feature high-speed access, a low operating current, and an ultra-low standby current. Control signal inputs include an  $\overline{OE}$  input for high-speed memory access and two chip enable inputs,  $\overline{CE1}$  and  $\overline{CE2}$ , for power-down and device selection. Thus these products are optimal for systems that require low power and/or battery backup and they support easy expansion of memory capacities. The ultra-low standby mode current drain allows capacitors to be used for backup and 3V operation makes these devices an excellent choice for use in battery operated portable equipment.

### Features

- Supply voltage : 2.7 to 5.5V
  - 5V operation :  $5.0V \pm 10\%$
  - 3V operation :  $3.0V \pm 10\%$
- Address access time ( $t_{AA}$ )
  - 5V operation
    - LC3564S, SS, SM, ST-70 : 70ns (max.)
    - LC3564S, SS, SM, ST-85 : 85ns (max.)
    - LC3564S, SS, SM, ST-10 : 100ns (max.)
  - 3V operation
    - LC3564S, SS, SM, SS-70 : 200ns (max.)
    - LC3564S, SS, SM, SS-85 : 250ns (max.)
    - LC3564S, SS, SM, SS-10 : 500ns (max.)
- Ultra-low standby current
  - 5V operation :  $1.0\mu A$  ( $T_a \leq 70^\circ C$ )  
 $3.0\mu A$  ( $T_a \leq 85^\circ C$ )
  - 3V operation :  $0.8\mu A$  ( $T_a \leq 70^\circ C$ )  
 $2.5\mu A$  ( $T_a \leq 85^\circ C$ )
- Operating temperature
  - 3V operation :  $-40^\circ C$  to  $+85^\circ C$
  - 5V operation :  $-40^\circ C$  to  $+85^\circ C$
- Data retention voltage : 2.0 to 5.5V
- All I/O levels
  - 5V operation : TTL compatible
  - 3V operation :  $V_{CC} - 0.2V/0.2V$
- Three control inputs ( $\overline{OE}$ ,  $\overline{CE1}$ ,  $\overline{CE2}$ )
- Common input/output pins, three-state outputs
- No clock or timing signals required

### Package :

- 28-pin DIP (600mil)plastic package : LC3564S
- 28-pin DIP (300mil)plastic package : LC3564SS
- 28-pin SOP (450mil)plastic package : LC3564SM
- 28-pin TSOP ( $8 \times 13.4$ mm)plastic package : LC3564ST

### Package Dimensions

unit : mm

#### 3012A-DIP28

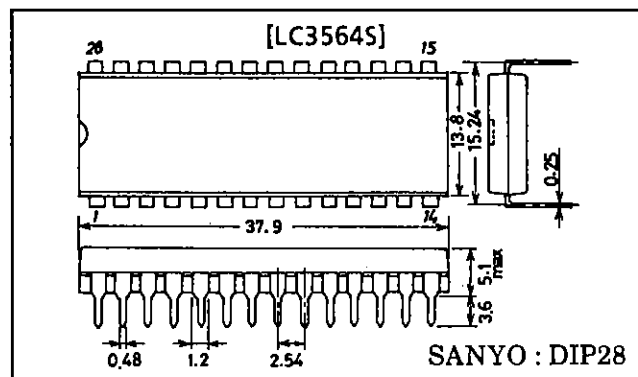

unit : mm

#### 3133-DIP28

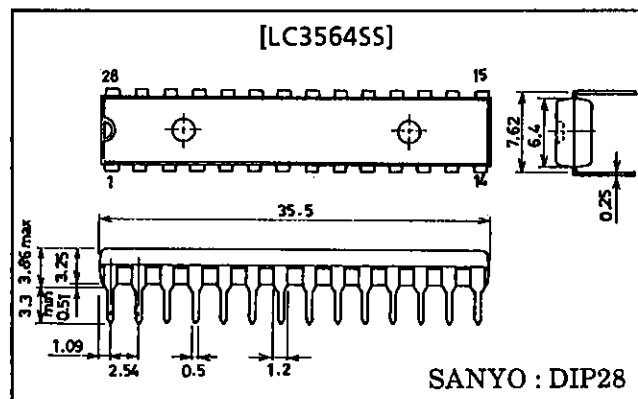

Pin Assignments

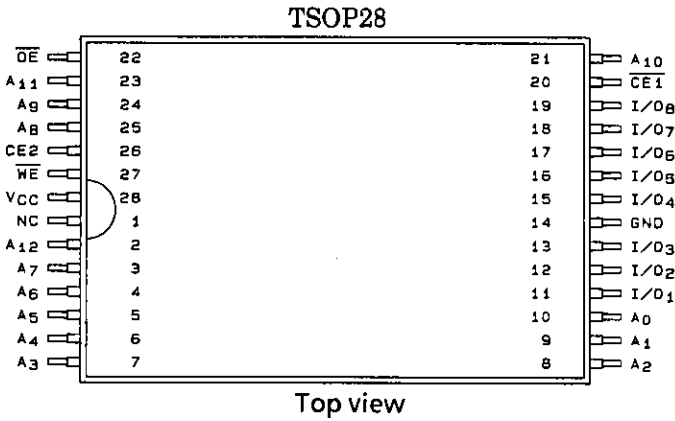
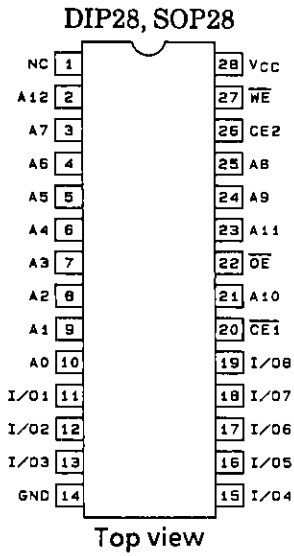

Package Dimensions

unit : mm  
3187-SOP28

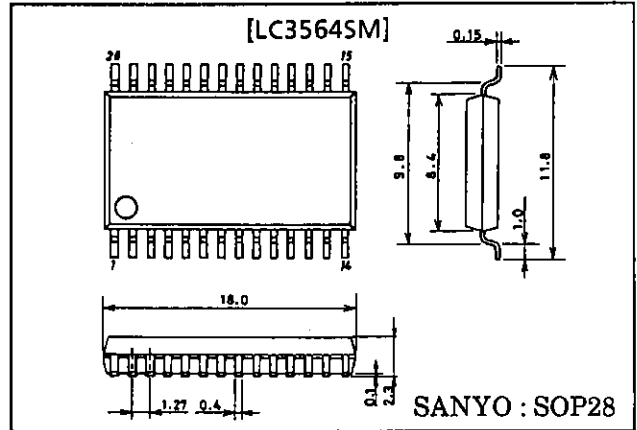

unit : mm  
3221-TSOP28

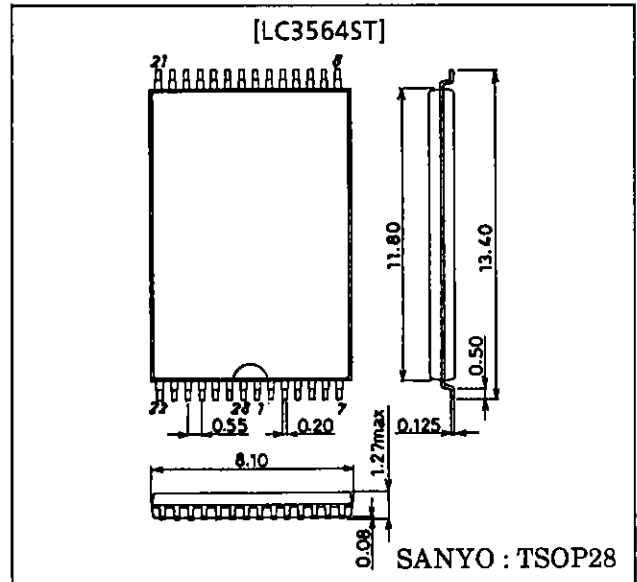

A0 to A12	Address input
$\overline{WE}$	Write enable
$\overline{OE}$	Output enable
$\overline{CE1}, \overline{CE2}$	Chip enable
I/O <sub>1</sub> to I/O <sub>8</sub>	Data input/output
VCC, GND	Power, ground

Block Diagram

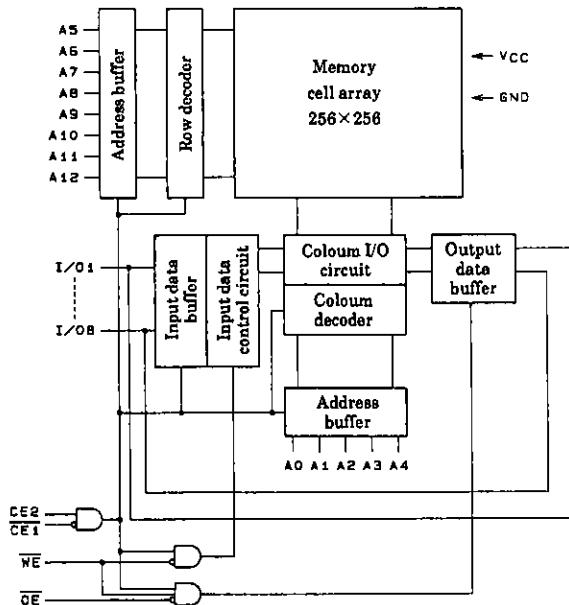

**Pin Functions**

Mode	$\overline{CE1}$	CE2	$\overline{OE}$	$\overline{WE}$	I/O	Current
Read Cycle	L	H	L	H	Data output	$I_{CCA}$
Write Cycle	L	H	×	L	Data input	$I_{CCA}$
Output Disable	L	H	H	H	High impedance	$I_{CCA}$
Unselected	H	×	×	×	High impedance	$I_{CCS}$
	×	L	×	×	High impedance	$I_{CCS}$

× : Arbitrary H or L

**Specifications**

**Absolute Maximum Ratings at  $T_a = 25^\circ\text{C}$**

Parameter	Symbol	Conditions	Ratings	Unit
Max supply voltage	$V_{CC\ max}$		7.0	V
Input voltage	$V_{IN}$		-0.3* to $V_{CC} + 0.3$	V
I/O voltage	$V_{I/O}$		-0.3 to $V_{CC} + 0.3$	V
Operating temperature range	$T_{opr}$		-40 to +85	°C
Storage temperature range	$T_{stg}$		-55 to +125	°C

\*) The inputs may undershoot to -3.0V (min.) for periods less than 30ns.

**I/O Capacitance at  $T_a = 25^\circ\text{C}$ ,  $f = 1\text{MHz}$**

Parameter	Symbol	Conditions	min	typ	max	Unit
Input/output capacitance	$C_{I/O}$	$V_{I/O} = 0\text{V}$		6	10	pF
Input capacitance	$C_I$	$V_{IN} = 0\text{V}$		6	10	pF

(Note) This parameter is sampled and not 100% tested.

5V Operation

DC Recommended Operating Ranges at  $T_a = -40$  to  $+85^\circ\text{C}$ ,  $V_{CC} = 4.5$  to  $5.5\text{V}$

Parameter	Symbol	min	typ	max	Unit
Supply voltage	$V_{CC}$	4.5	5.0	5.5	V
Input voltage	$V_{IH}$	2.2		$V_{CC} + 0.3$	V
	$V_{IL}$	-0.3*		+0.8	V

\*) The inputs may undershoot to  $-3.0\text{V}$  (min.) for periods less than 30ns.

DC Electrical Characteristics at  $T_a = -40$  to  $+85^\circ\text{C}$ ,  $V_{CC} = 4.5$  to  $5.5\text{V}$

Parameter	Symbol	Conditions	min	typ*	max	Unit		
Input leakage current	$I_{LI}$	$V_{IN} = 0$ to $V_{CC}$	-1.0		+1.0	$\mu\text{A}$		
I/O leakage current	$I_{LO}$	$V_{\overline{CE1}} = V_{IH}$ or $V_{CE2} = V_{IL}$ or $V_{\overline{OE}} = V_{IH}$ or $V_{\overline{WE}} = V_{IL}$ , $V_{I/O} = 0$ to $V_{CC}$	-1.0		+1.0	$\mu\text{A}$		
Output high level voltage	$V_{OH}$	$I_{OH} = -1.0\text{mA}$	2.4			V		
Output low level voltage	$V_{OL}$	$I_{OL} = 2.0\text{mA}$			0.4	V		
Operating current	$V_{CC} - 0.2\text{V}/$ $0.2\text{V}$ input	$I_{CCA1}$	$V_{\overline{CE1}} \cong 0.2\text{V}$ , $V_{CE2} \cong V_{CC} - 0.2\text{V}$ , $I_{I/O} = 0\text{mA}$ , $V_{IN} \cong 0.2\text{V}$ or $V_{IN} \cong V_{CC} - 0.2\text{V}$		$T_a \leq 70^\circ\text{C}$	0.01	1.0	$\mu\text{A}$
			$T_a \leq 85^\circ\text{C}$		3.0			
		$I_{CCA4}$	$V_{\overline{CE1}} \cong 0.2\text{V}$ , $V_{CE2} \cong V_{CC} - 0.2\text{V}$ , $I_{I/O} = 0\text{mA}$ , DUTY 100%	min cycle	LC3564S, SS, SM, ST-70		35	mA
					LC3564S, SS, SM, ST-85		35	
	LC3564S, SS, SM, ST-10					30		
			1 $\mu\text{s}$ cycle			4		mA
	TTL input	$I_{CCA2}$	$V_{\overline{CE1}} = V_{IL}$ , $V_{CE2} = V_{IH}$ , $I_{I/O} = 0\text{mA}$ , $V_{IN} = V_{IH}$ or $V_{IL}$				7	mA
			$I_{CCA3}$	$V_{\overline{CE1}} = V_{IL}$ , $V_{CE2} = V_{IH}$ , $I_{I/O} = 0\text{mA}$ , DUTY 100%	min cycle	LC3564S, SS, SM, SS-70		
		LC3564S, SS, SM, SS-85					40	
		LC3564S, SS, SM, SS-10					35	
		1 $\mu\text{s}$ cycle			7		mA	
Standby current	$V_{CC} - 0.2\text{V}/$ $0.2\text{V}$ input	$I_{CCS1}$	$V_{CE2} \cong 0.2\text{V}$ or $V_{\overline{CE1}} \cong V_{CC} - 0.2\text{V}$ $V_{CE2} \cong V_{CC} - 0.2\text{V}$		$T_a \leq 70^\circ\text{C}$	0.01	1.0	$\mu\text{A}$
			$T_a \leq 85^\circ\text{C}$		3.0			
	TTL input	$I_{CCS2}$	$V_{CE2} = V_{IL}$ or $V_{\overline{CE1}} = V_{IH}$ , $V_{IN} = 0$ to $V_{CC}$				2.0	mA

\*) Reference value at  $V_{CC} = 5\text{V}$ ,  $T_a = 25^\circ\text{C}$

**LC3564S, SS, SM, ST-70/85/10**

**AC Electrical Characteristics at Ta = -40 to +85°C, V<sub>CC</sub> = 4.5 to 5.5V**

AC test conditions

Input pulse levels : V<sub>IH</sub> = 2.4V, V<sub>IL</sub> = 0.6V  
 Input rise and fall time : 5ns  
 Input and output timing reference levels : 1.5V  
 Output load LC3564S, SS, SM, ST-70 : 30pF + 1TTL gate  
 (including jig capacitance)  
 LC3564S, SS, SM, ST-85/10 : 100pF + 1TTL gate  
 (including jig capacitance)

**Read Cycle**

Parameter	Symbol	LC3564S, SS, SM, ST						Unit
		-70		-85		-10		
		min	max	min	max	min	max	
Read cycle time	t <sub>RC</sub>	70		85		100		ns
Address access time	t <sub>AA</sub>		70		85		100	ns
$\overline{\text{CE1}}$ access time	t <sub>CA1</sub>		70		85		100	ns
CE2 access time	t <sub>CA2</sub>		70		85		100	ns
$\overline{\text{OE}}$ access time	t <sub>OA</sub>		35		45		50	ns
Output hold time	t <sub>OH</sub>	10		10		10		ns
$\overline{\text{CE1}}$ - output enable time	t <sub>COE1</sub>	10		10		10		ns
CE2 - output enable time	t <sub>COE2</sub>	10		10		10		ns
$\overline{\text{OE}}$ - output enable time	t <sub>OOE</sub>	5		5		5		ns
$\overline{\text{CE1}}$ - output disable time	t <sub>COD1</sub>		30		35		35	ns
CE2 - output disable time	t <sub>COD2</sub>		30		35		35	ns
$\overline{\text{OE}}$ - output disable time	t <sub>OOD</sub>		25		25		25	ns

**Write Cycle**

Parameter	Symbol	LC3564S, SS, SM, ST						Unit
		-70		-85		-10		
		min	max	min	max	min	max	
Write cycle time	t <sub>WC</sub>	70		85		100		ns
Address setup time	t <sub>AS</sub>	0		0		0		ns
Write pulse width	t <sub>WP</sub>	50		55		55		ns
$\overline{\text{CE1}}$ setup time	t <sub>CW1</sub>	60		65		65		ns
CE2 setup time	t <sub>CW2</sub>	60		65		65		ns
Write recovery time	t <sub>WR</sub>	0		0		0		ns
$\overline{\text{CE1}}$ write recovery time	t <sub>WR1</sub>	0		0		0		ns
CE2 write recovery time	t <sub>WR2</sub>	0		0		0		ns
Data setup time	t <sub>DS</sub>	35		40		40		ns
Data hold time	t <sub>DH</sub>	0		0		0		ns
$\overline{\text{CE1}}$ data hold time	t <sub>DH1</sub>	0		0		0		ns
CE2 data hold time	t <sub>DH2</sub>	0		0		0		ns
$\overline{\text{WE}}$ - output enable time	t <sub>WOE</sub>	5		5		5		ns
$\overline{\text{WE}}$ - output disable time	t <sub>WOD</sub>		30		35		35	ns

**3V Operation**

**DC Recommended Operating Ranges** at  $T_a = -40$  to  $+85^\circ\text{C}$ ,  $V_{CC} = 2.7$  to  $3.3\text{V}$

Parameter	Symbol	min	typ	max	Unit
Supply voltage	$V_{CC}$	2.7	3.0	3.3	V
Input voltage	$V_{IH}$	$V_{CC} - 0.2$		$V_{CC}$	V
	$V_{IL}$	0		0.2	V

**DC Electrical Characteristics** at  $T_a = -40$  to  $+85^\circ\text{C}$ ,  $V_{CC} = 2.7$  to  $3.3\text{V}$

Parameter		Symbol	Conditions		min	typ*	max	Unit	
Input leakage current		$I_{LI}$	$V_{IN} = 0$ to $V_{CC}$		-1.0		+1.0	$\mu\text{A}$	
I/O leakage current		$I_{LO}$	$V_{CE1} = V_{IH}$ or $V_{CE2} = V_{IL}$ or $V_{OE} = V_{IH}$ or $V_{WE} = V_{IL}$ , $V_{I/O} = 0$ to $V_{CC}$		-1.0		+1.0	$\mu\text{A}$	
Output high level voltage		$V_{OH}$	$I_{OH} = -0.5\text{mA}$		$V_{CC} - 0.2\text{V}$			V	
Output low level voltage		$V_{OL}$	$I_{OL} = 1.0\text{mA}$				0.2	V	
Operating current	$V_{CC} - 0.2\text{V}/0.2\text{V}$ input	$I_{CCA1}$	$V_{CE1} \leq V_{IL}$ , $V_{CE2} \geq V_{IH}$ , $I_{I/O} = 0\text{mA}$ , $V_{IN} \geq V_{IL}$ , $V_{IN} \geq V_{IH}$		$T_a \leq 70^\circ\text{C}$	0.01	0.8	$\mu\text{A}$	
					$T_a \leq 85^\circ\text{C}$		2.5		
		$I_{CCA4}$	$V_{CE1} \leq V_{IL}$ , $V_{CE2} \geq V_{IH}$ , $I_{I/O} = 0\text{mA}$ , DUTY = 100%	min cycle	LC3564S, SS, SM, ST-70			20	mA
					LC3564S, SS, SM, ST-85			20	
			LC3564S, SS, SM, ST-10			10			
			1 $\mu\text{s}$ cycle			3		mA	
Standby current	$V_{CC} - 0.2\text{V}/0.2\text{V}$ input	$I_{CCS1}$	$V_{CE2} \leq V_{IL}$ or $V_{CE1} \geq V_{IH}$ $V_{CE2} \geq V_{IH}$		$T_a \leq 70^\circ\text{C}$	0.01	0.8	$\mu\text{A}$	
					$T_a \leq 85^\circ\text{C}$		2.5		

\*) Reference value at  $V_{CC} = 3\text{V}$ ,  $T_a = 25^\circ\text{C}$

**LC3564S, SS, SM, ST-70/85/10**

**AC Electrical Characteristics** at  $T_a = -40$  to  $+85^\circ\text{C}$ ,  $V_{CC} = 2.7$  to  $3.3\text{V}$

AC test conditions

Input pulse levels		: $V_{IH} = V_{CC} - 0.2\text{V}$ , $V_{IL} = 0.2\text{V}$
Input rise and fall time		: 10ns
Input and output timing reference levels		: 1.5V
Output load	LC3564S, SS, SM, ST-70	: 30pF (including scope and jig)
	LC3564S, SS, SM, ST-85/10	: 100pF (including scope and jig)

**Read Cycle**

Parameter	Symbol	LC3564S, SS, SM, ST						Unit
		-70		-85		-10		
		min	max	min	max	min	max	
Read cycle time	$t_{RC}$	200		250		500		ns
Address access time	$t_{AA}$		200		250		500	ns
$\overline{CE1}$ access time	$t_{CA1}$		200		250		500	ns
CE2 access time	$t_{CA2}$		200		250		500	ns
$\overline{OE}$ access time	$t_{OA}$		100		130		250	ns
Output hold time	$t_{OH}$	20		20		20		ns
$\overline{CE1}$ - output enable time	$t_{COE1}$	20		20		20		ns
CE2 - output enable time	$t_{COE2}$	20		20		20		ns
$\overline{OE}$ - output enable time	$t_{OOE}$	10		10		10		ns
$\overline{CE1}$ - output disable time	$t_{COD1}$		60		80		120	ns
CE2 - output disable time	$t_{COD2}$		60		80		120	ns
$\overline{OE}$ - output disable time	$t_{OOD}$		50		70		100	ns

**Write Cycle**

Parameter	Symbol	LC3564S, SS, SM, ST						Unit
		-70		-85		-10		
		min	max	min	max	min	max	
Write cycle time	$t_{WC}$	200		250		500		ns
Address setup time	$t_{AS}$	0		0		0		ns
Write pulse width	$t_{WP}$	140		160		200		ns
$\overline{CE1}$ setup time	$t_{CW1}$	150		180		250		ns
CE2 setup time	$t_{CW2}$	150		180		250		ns
Write recovery time	$t_{WR}$	0		0		0		ns
$\overline{CE1}$ write recovery time	$t_{WR1}$	0		0		0		ns
CE2 write recovery time	$t_{WR2}$	0		0		0		ns
Data setup time	$t_{DS}$	130		150		180		ns
Data hold time	$t_{DH}$	0		0		0		ns
$\overline{CE1}$ data hold time	$t_{DH1}$	0		0		0		ns
CE2 data hold time	$t_{DH2}$	0		0		0		ns
$\overline{WE}$ - output enable time	$t_{WOE}$	10		10		10		ns
$\overline{WE}$ - output disable time	$t_{WOD}$		60		80		120	ns

Timing Waveform

Read Cycle Note (1)

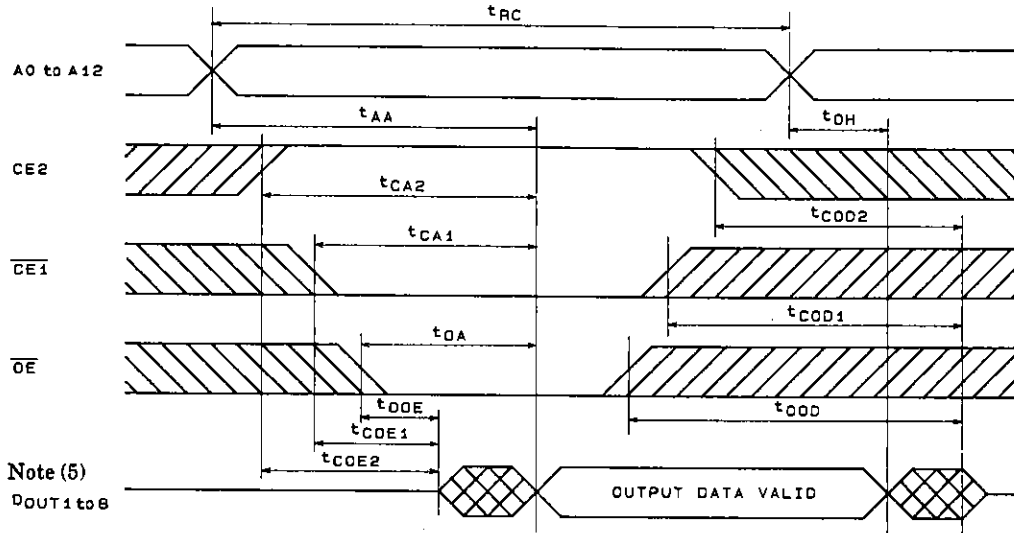

Write Cycle 1 ( $\overline{WE}$  Write) Note (6)

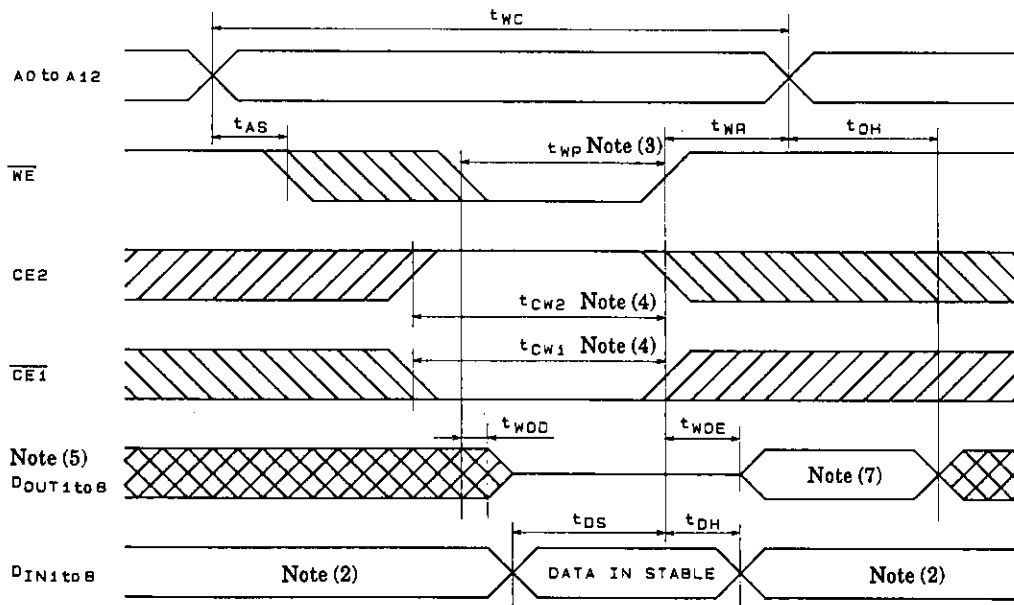



Write Cycle 2 ( $\overline{CE1}$  Write) Note (6)

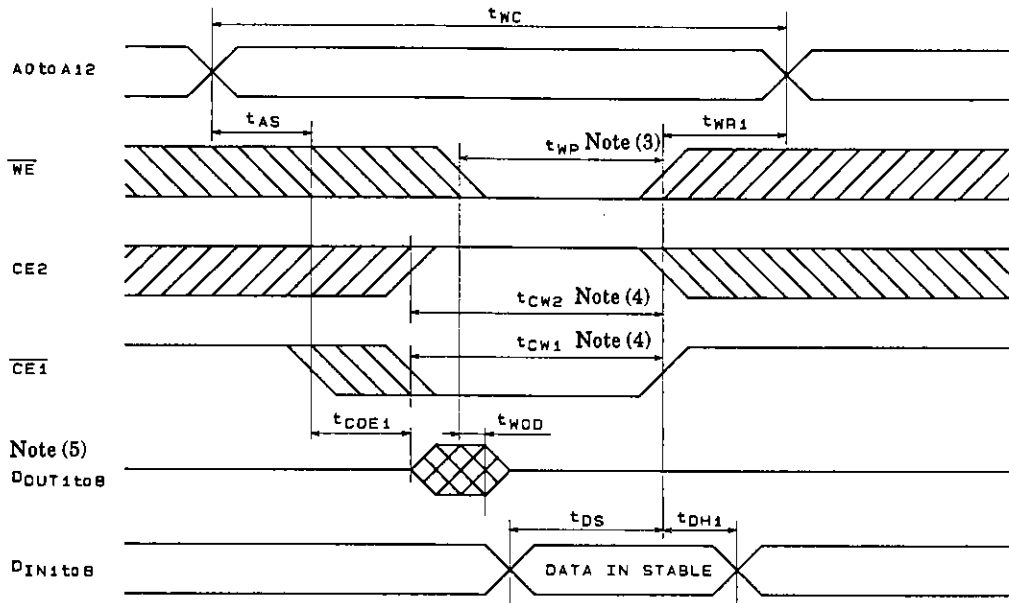

Write Cycle 3 (CE2 Write) Note (6)

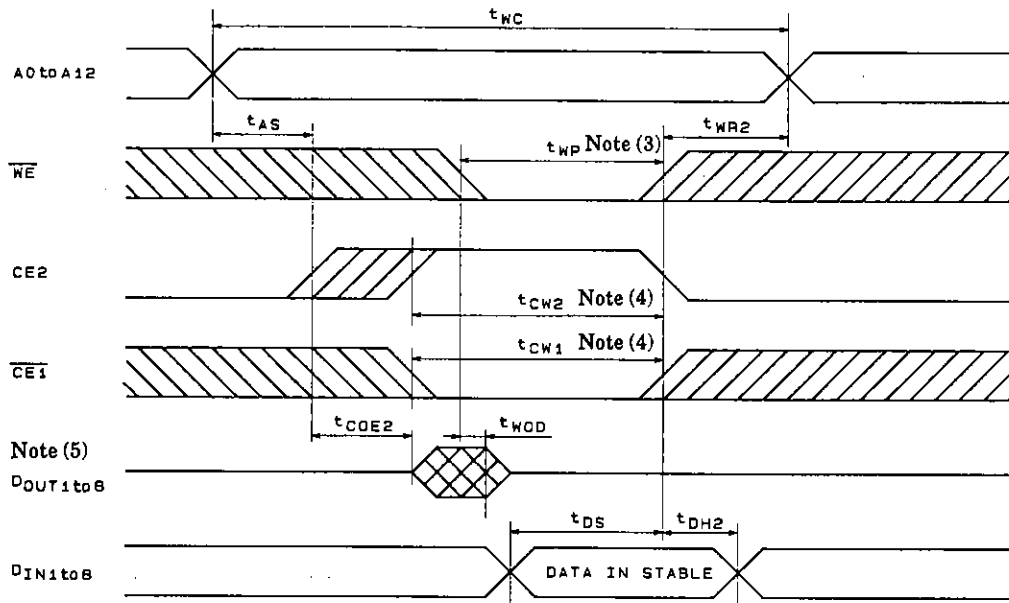

Notes : (1) In Read Cycle,  $\overline{WE}$  should be high.

(2) During this period, I/O pins are in the output state, therefore the input signals of opposite phase to the outputs must not be applied.

(3) A write occurs during the overlap of a low  $\overline{CE1}$ , a high CE2 and a low  $\overline{WE}$ .  
 A write begins at the latest transition among  $\overline{CE1}$  going low, CE2 going high and  $\overline{WE}$  going low.  
 A write ends at the earliest transition among  $\overline{CE1}$  going high, CE2 going low and  $\overline{WE}$  going high.

$t_{WP}$  is measured from the beginning of write to the end of write.

(4)  $t_{COW1}$ ,  $t_{COW2}$  are measured from the later of  $\overline{CE1}$  going low or CE2 going high to the end of write.

(5) If one of these conditions ( $\overline{OE}$  is high,  $\overline{CE1}$  is high, CE2 is low,  $\overline{WE}$  is low) at least is satisfied,  $D_{OUT}$  goes to high impedance state.

(6) In Write Cycle,  $\overline{OE} = V_{IH}$  or  $V_{IL}$ .

(7)  $D_{OUT}$  is in the same phase of written data of this cycle.

Data Retention Characteristics at  $T_a = -40$  to  $+85^\circ\text{C}$

Parameter	Symbol	Conditions	min	typ	max	Unit
Date retention supply voltage	$V_{DR}$	$V_{CE2} \leq 0.2\text{V}$ , or $V_{CE1} \geq V_{CC} - 0.2\text{V}$ or $V_{CE2} \geq V_{CC} - 0.2\text{V}$	2.0		5.5	V
Data retention current	$I_{CCDR}$	$V_{CC} = 3\text{V}$ , $V_{CE2} \leq 0.2\text{V}$ , or $V_{CE1} \geq V_{CC} - 0.2\text{V}$ or $V_{CE2} \geq V_{CC} - 0.2\text{V}$	$T_a \leq 70^\circ\text{C}$		0.8	$\mu\text{A}$
			$T_a \leq 85^\circ\text{C}$		2.5	
Chip enable setup time	$t_{CDR}$		0			ns
Chip enable hold time	$t_R$		$t_{RC}^*$			ns

\*)  $t_{RC}$  = Read Cycle Time

Data Retention Waveform (1) ( $\overline{CE1}$  CONTROL)

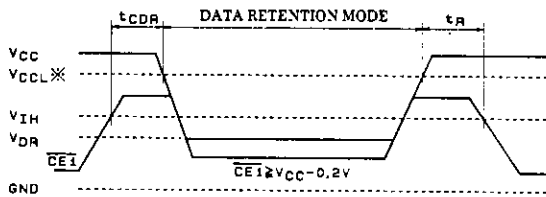

Data Retention Waveform (2) (CE2 CONTROL)

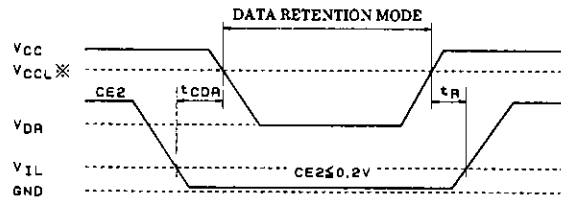

\*)  $V_{CCL}$  —  $\begin{cases} 5\text{V operation} : 4.5\text{V} \\ 3\text{V operation} : 2.7\text{V} \end{cases}$

- No products described or contained herein are intended for use in surgical implants, life-support systems, aerospace equipment, nuclear power control systems, vehicles, disaster/crime-prevention equipment and the like, the failure of which may directly or indirectly cause injury, death or property loss.
- Anyone purchasing any products described or contained herein for an above-mentioned use shall:
  - ① Accept full responsibility and indemnify and defend SANYO ELECTRIC CO., LTD., its affiliates, subsidiaries and distributors and all their officers and employees, jointly and severally, against any and all claims and litigation and all damages, cost and expenses associated with such use:
  - ② Not impose any responsibility for any fault or negligence which may be cited in any such claim or litigation on SANYO ELECTRIC CO., LTD., its affiliates, subsidiaries and distributors or any of their officers and employees jointly or severally.
- Information (including circuit diagrams and circuit parameters) herein is for example only; it is not guaranteed for volume production. SANYO believes information herein is accurate and reliable, but no guarantees are made or implied regarding its use or any infringements of intellectual property rights or other rights of third parties.

This catalog provides information as of May, 1996. Specifications and information herein are subject to change without notice.