	No. ※ 4711A	LC338128P, M, PL, ML-70/80/10
	1 MEG (131072 words × 8 bits) Pseudo-SRAM	

Preliminary

Overview

The LC338128 series is composed of pseudo static RAM that operate on a single 5 V power supply and is organized as 65536 words × 16 bits. By using memory cells each composed of a single transistor and capacitor, together with peripheral CMOS circuitry, this series achieves ease of use with high density, high speed, and low power dissipation. Since the LC338128 series products provide refresh counter and timer on chip, this series can easily accomplish auto-refresh and self-refresh by means of $\overline{\text{RFSH}}$ input. The available packages are the 32-pin DIP with a width of 600 mil, and the 32-pin SOP with a width of 525 mil.

Features

- 131072 words × 8 bits configuration
- $\overline{\text{CE}}$ access time, $\overline{\text{OE}}$ access time, cycle time, operating supply current and self-refresh current 2.

Parameter	LC338128P, M, PL, ML		
	-70	-80	-10
$\overline{\text{CE}}$ access time	70 ns	80 ns	100 ns
$\overline{\text{OE}}$ access time	25 ns	30 ns	40 ns
Cycle time	115 ns	130 ns	160 ns
Operating supply current	80 mA	70 mA	60 mA
Self-refresh current 2	1 mA/100 μ A (L version)		

- Single 5 V \pm 10% power supply
- All inputs and outputs (I/O) TTL compatible
- Fast access time and low power dissipation
- 8 ms refresh using 512 refresh cycles
- Supports auto-refresh, self-refresh and $\overline{\text{CE}}$ -only refresh
- Low-power version: 100 μ A standby current 2, $I_{\text{CCSR}2} = 100 \mu\text{A}$
- Packages
32-pin DIP (600mil) plastic package: LC338128P, PL
32-pin SOP (450mil) plastic package: LC338128M, ML

Package Dimensions

unit: mm

3192-DIP32

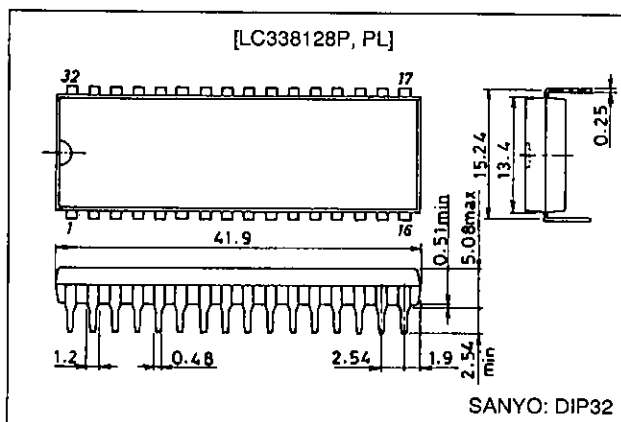

unit: mm

3205-SOP32

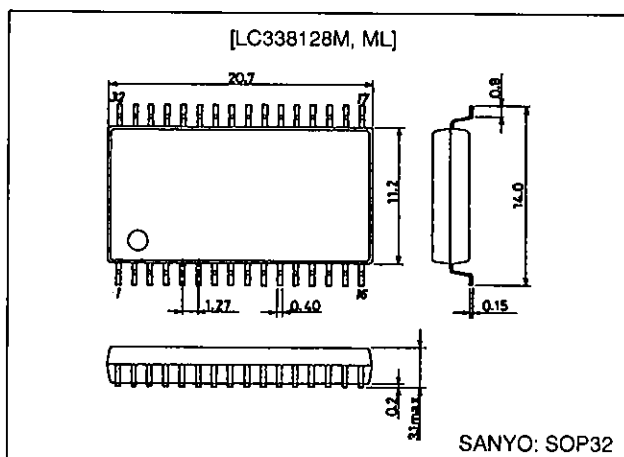

Block Diagram

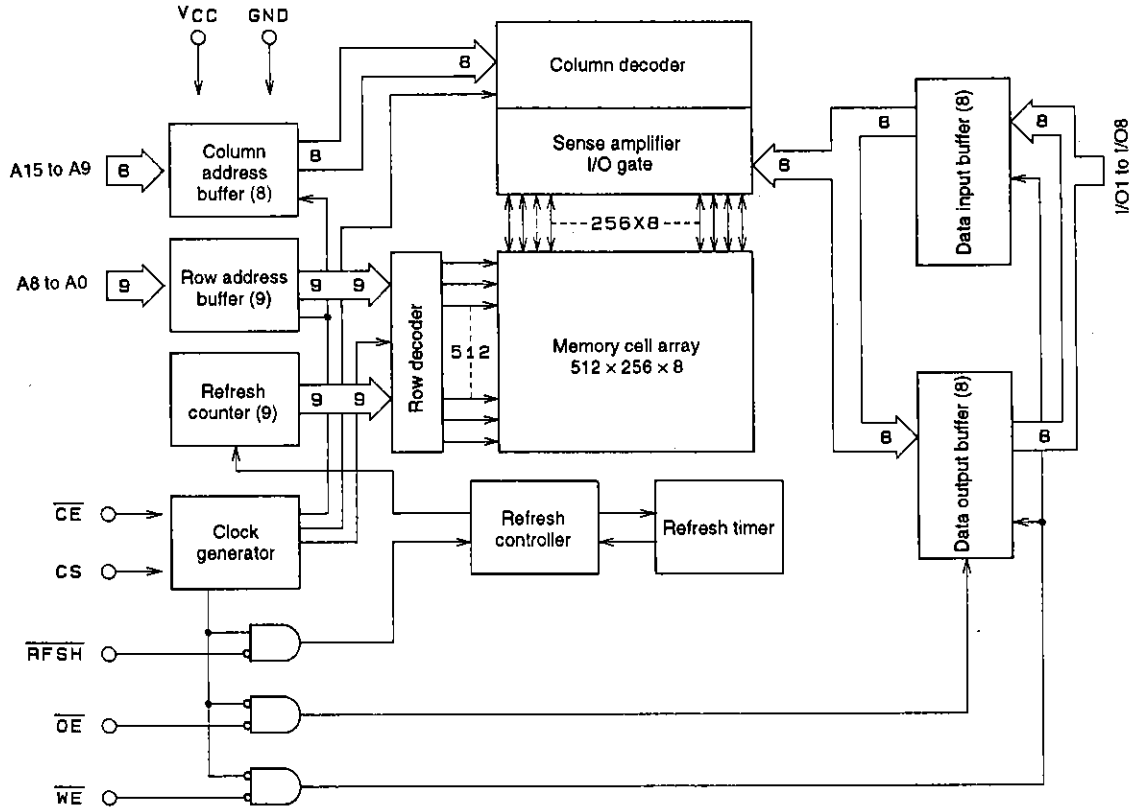

A01931

Pin Assignment

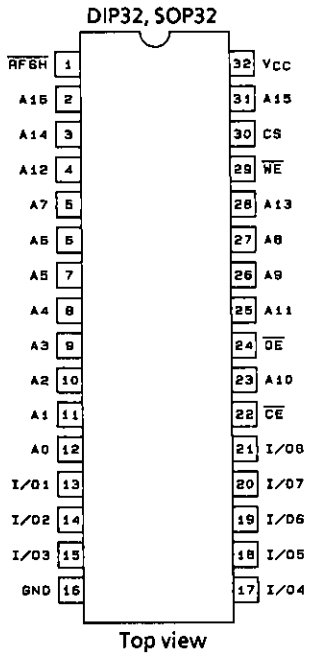

A01932

Pin Functions

A0 to A16	Address Input
WA	Read/write Input
OE	Output enable input
RFSH	Refresh Input
CE	Chip enable input
CS	Chip select input
I/O1 to I/O8	Data Input/output
Vcc	Power supply
GND	Ground

Function Logic

\overline{CE}	CS	\overline{OE}	\overline{WE}	\overline{RFSH}	A0 to A8	A9 to A15	I/O1 to I/O8	State
L	H	L	H	X	VX	VX	OUT	Read
L	H	X	L	X	VX	VX	IN	Write
L	H	H	H	X	VX	X	HZ	\overline{CE} only refresh
L	L	X	X	X	X	X	HZ	CS standby
H	X	X	X	L	X	X	HZ	Self-refresh
H	X	X	X	NP	X	X	HZ	Auto-refresh
H	X	X	X	H	X	X	HZ	Standby

H: High-level input of $V_{IN} = 6.5$ V to V_{IH} (min)
 L: Low-level input of $V_{IN} = V_{IL}$ (max) to -1.0 V
 NP: Negative-polarity pulse input
 X: High- or low-level input
 VX: "IN" when $\overline{CE} = L$ is confirmed, then "X"
 HZ: High impedance
 IN: Input state
 OUT: Output state

Specifications

Absolute Maximum Ratings

Parameter	Symbol	Ratings	Unit	Note
Maximum supply voltage	V_{CC} max	-1.0 to +7.0	V	1
Input voltage	V_{IN}	-1.0 to +7.0	V	1
Output voltage	V_{OUT}	-1.0 to +7.0	V	1
Allowable power dissipation	P_d max	600	mW	1
Output short current	I_{OUT}	50	mA	1
Operating temperature range	T_{opr}	0 to +70	°C	1
Storage temperature range	T_{stg}	-55 to +150	°C	1

Note: 1. Stresses greater than the above listed maximum values may result in damage to the device.

DC Recommended Operating Ranges at $T_a = 0$ to +70°C

Parameter	Symbol	min	typ	max	Unit	Note
Supply voltage	V_{CC}	4.5	5.0	5.5	V	2
Input high level voltage	V_{IH}	2.4		6.5	V	2
Input low level voltage	V_{IL}	-1.0		+0.8	V	2

Note: 2. All voltages are referenced to GND.

LC338128P, M, PL, ML-70/80/10

DC Electrical Characteristics at Ta = 0 to +70°C, VCC = 5 V ± 10%

Parameter	Symbol	Conditions		min	max	Unit	Note		
Operating current (average current during operation)	I _{CCA}	t _{RC} = t _{RC} (min)	Access time	70 ns		70	mA	3, 4	
				80 ns		80			
				100 ns		100			
Standby current 1	I _{CCS1}	$\overline{CE} = \overline{RFSH} = V_{IH}$	LC338128P, M LC338128PL, ML			2 1	mA		
Standby current 2	I _{CCS2}	$\overline{CE} = \overline{RFSH} = V_{CC} - 0.2 V$	LC338128P, M			1	mA		
			LC338128PL, ML			100	µA		
Self-refresh current 1 (average current)	I _{CCSR1}	$\overline{CE} = V_{IH}, \overline{RFSH} = V_{IL}$	LC338128P, M			2	mA		
			LC338128PL, ML			1	µA		
Self-refresh current 2 (average current)	I _{CCSR2}	$\overline{CE} = V_{CC} - 0.2 V, \overline{RFSH} = 0.2 V$	LC338128P, M			1	mA		
			LC338128PL, ML			100	µA		
Input leakage current	I _{IL}	0 V ≤ V _{IN} ≤ V _{CC} , pins other than measuring pin = 0 V				-10	+10	µA	
Output leakage current	I _{OL}	Output disable, 0 V ≤ V _{OUT} ≤ V _{CC}				-10	+10	µA	
Output high level voltage	V _{OH}	I _{OH} = -1 mA				2.4		V	
Output low level voltage	V _{OL}	I _{OL} = 2.1 mA					0.4	V	

Note: 3. All current values are measured at minimum cycle rate. Since current flows immoderately, if cycle time is longer than shown here, current value becomes smaller. A bypass capacitor of 0.01 µF or larger should be inserted between V_{CC} and GND for each memory chip to suppress power supply noise (voltage drops) due to transient currents.

4. Dependent on output load. Maximum value is value during free state.

Input/Output Capacitance at Ta = 25°C, VCC = 5 V ± 10%, f = 1 MHz

Parameter	Symbol	Measuring conditions	min	max	Unit
Input capacitance (A0 to A16)	C _{IN1}	V _{IN1} = 0 V		5	pF
Input capacitance (\overline{CE} , CS, \overline{OE} , \overline{RFSH} and \overline{WE})	C _{IN2}	V _{IN2} = 0 V		7	pF
I/O capacitance	C _{I/O}	V _{I/O} = 0 V		10	pF

Sampling inspections, and not full-lot inspections, are carried out for these parameters.

AC Electrical Characteristics at Ta = 0 to +70°C, VCC = 5 V ± 10% (Notes 5, 6, 7, 8)

Parameter	Symbol	-70		-80		-100		Unit	Note
		min	max	min	max	min	max		
Random read or write cycle time	t _{RC}	115		130		160		ns	
Read-modify-write cycle time	t _{RMW}	165		195		235		ns	
\overline{CE} pulse width	t _{CE}	70	10000	80	10000	100	10000	ns	
\overline{CE} precharge time	t _p	35		40		50		ns	
\overline{CE} access time	t _{CEA}		70		80		100	ns	
\overline{OE} access time	t _{OEa}		25		30		40	ns	
\overline{CE} output enable time	t _{CLZ}	20		25		30		ns	
\overline{OE} output enable time	t _{OLZ}	0		0		0		ns	
\overline{WE} output enable time	t _{WLZ}	0		0		0		ns	
\overline{CE} output disable time	t _{CHZ}	0	20	0	25	0	30	ns	9
\overline{OE} output disable time	t _{OHZ}	0	20	0	25	0	30	ns	9
\overline{WE} output disable time	t _{WHZ}	0	20	0	25	0	30	ns	9
\overline{OE} disable setup time	t _{ODS}	0		0		0		ns	
\overline{OE} disable hold time	t _{ODH}	10		10		10		ns	
Read command setup time	t _{RCS}	0		0		0		ns	
Read command hold time	t _{RCH}	0		0		0		ns	
Chip select setup time	t _{CSS}	0		0		0		ns	
Chip select hold time	t _{CSH}	15		20		25		ns	
Write pulse width	t _{WP}	30		60		70		ns	
Write command hold time	t _{WCH}	55	10000	60	10000	70	10000	ns	
Write command lead time	t _{CWL}	40	10000	60	10000	70	10000	ns	
Input data setup time for \overline{WE}	t _{DSW}	30		35		40		ns	10
Input data setup time for \overline{CE}	t _{DSC}	30		35		40		ns	10

Continued on next page.

LC338128P, M, PL, ML-70/80/10

Continued from preceding page.

Parameter	Symbol	-70		-80		-100		Unit	Note
		min	max	min	max	min	max		
Input data hold time for \overline{WE}	t_{DHW}	0		0		0		ns	10
Input data hold time for \overline{CE}	t_{DHC}	0		0		0		ns	10
Address setup time for \overline{CE}	t_{ASC}	0		0		0		ns	11
Address hold time for \overline{CE}	t_{AHC}	15		20		25		ns	11
Refresh command hold time	t_{RHC}	15		15		15		ns	
Auto-refresh cycle time	t_{FC}	115		130		160		ns	
\overline{RFSH} delay time for \overline{CE}	t_{RFD}	35		40		50		ns	
\overline{RFSH} pulse width (auto-refresh)	t_{FAP}	30	8000	30	8000	30	8000	ns	12
\overline{RFSH} precharge time (auto-refresh)	t_{FP}	30		30		30		ns	12
\overline{RFSH} pulse width (self-refresh)	t_{FAS}	8000		8000		8000		ns	12
\overline{RFSH} precharge \overline{CE} delay time (self-refresh)	t_{FRS}	135		160		190		ns	12
Refresh time (512 cycles, A0 to A8)	t_{REF}		8		8		8	ms	
Rise or fall times	t_T	3	50	3	50	3	50	ns	

Note: 5. To accomplish internal initialization, \overline{CE} is fixed at V_{IH} for an interval of 1 ms when V_{CC} reaches the specified voltage after power is switched on. At least eight cycles must be executed following that period.

6. Measured at $t_T = 5$ ns.

7. When measuring input signal timing, V_{IH} (min) and V_{IL} (max) are reference levels.

8. Measured using an equivalent of 100 pF and two standard TTL loads.

9. t_{CHZ} , t_{OHZ} and t_{WHZ} are defined as the time until output enters the open circuit state and the output voltage level becomes immeasurable.

10. As with ordinary static RAM, write data is incorporated at the rise of \overline{WE} input or \overline{CE} input, whichever is earlier, and write data is therefore held during t_{DSW} , t_{DSC} , t_{DHW} , or t_{DHC} .

11. Because address input is incorporated at the fall of \overline{CE} , the address is maintained during t_{ASC} or t_{AHC} .

12. Auto-refresh and self-refresh are determined by \overline{RFSH} pulse width when $\overline{CE} = V_{IH}$, and are defined as auto-refresh when below t_{FAP} (max), or as self-refresh when above t_{FAS} (min). In order to activate \overline{CE} after the completion of each refresh, t_{FCE} must be assured for auto-refresh, or t_{FRS} must be assured for self-refresh.

Similarly, if self-refresh timing ($\overline{RFSH} = \text{Low}$) is used after power is switched on, t_{FRS} must be assured.

Timing Chart

Read Cycle

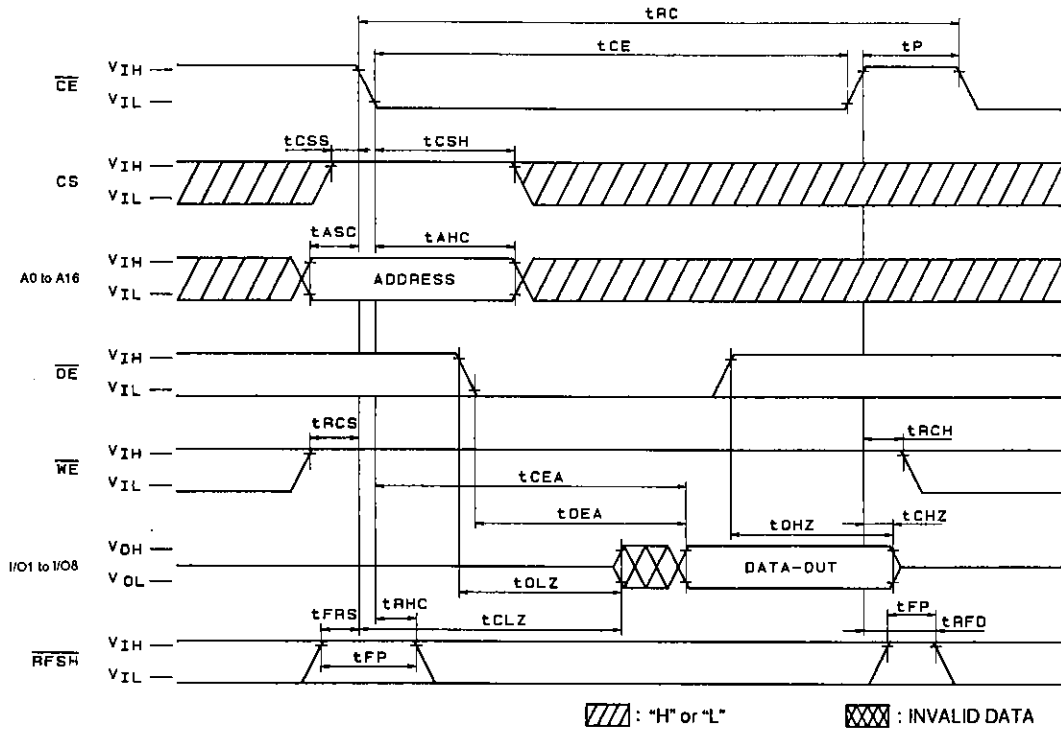

A01933

Write Cycle 1 (\overline{OE} Fix High)

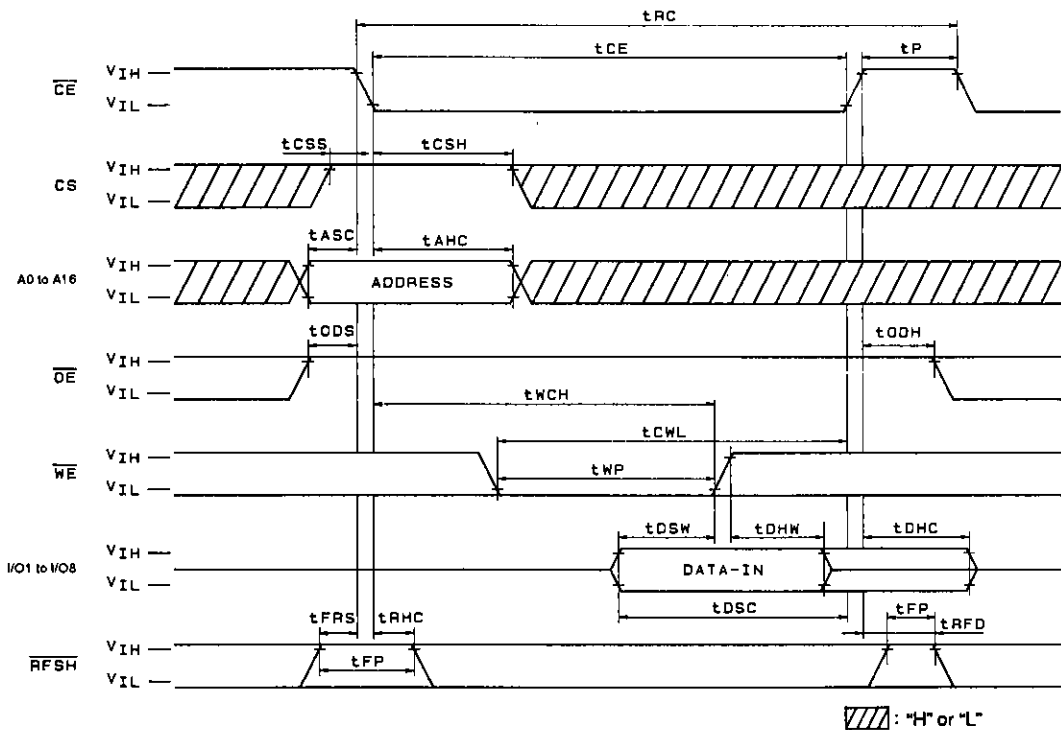

A01934

Write Cycle 2 (\overline{OE} Clock)

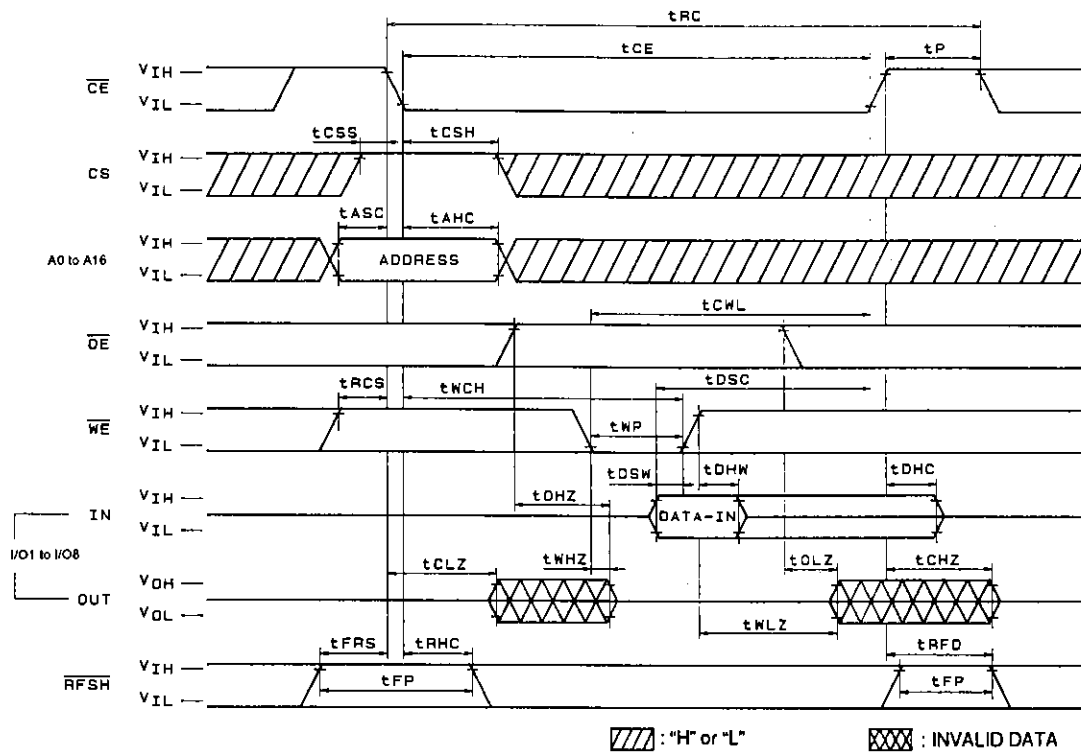

A01935

Write Cycle 3 (\overline{OE} Fix Low)

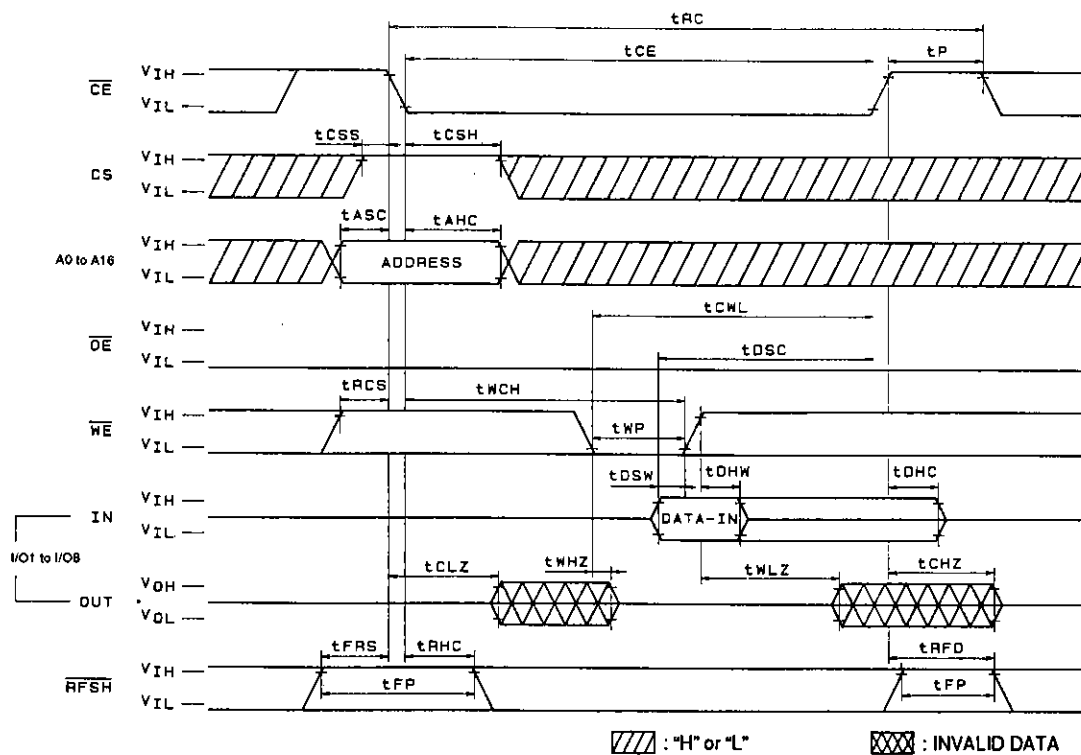

A01936

Read-Modify-Write Cycle

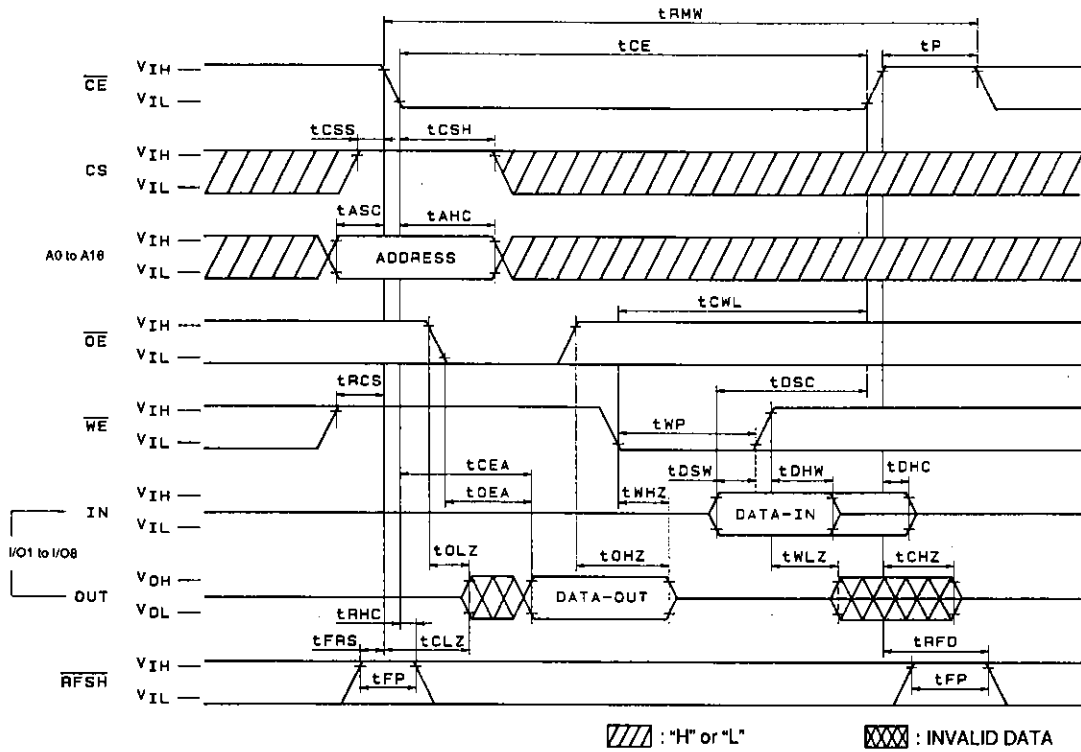

A01937

\overline{CE} -Only Refresh Cycle

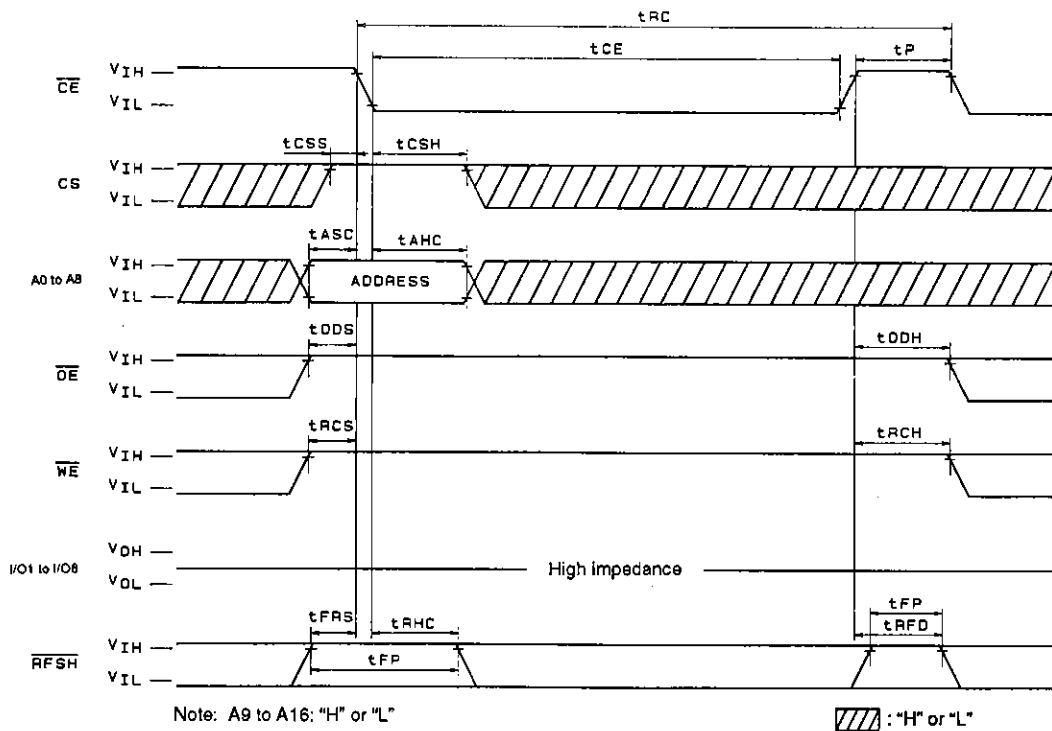

Note: $A9$ to $A16$: "H" or "L"

/// : "H" or "L"

A01938

Auto-Refresh Cycle

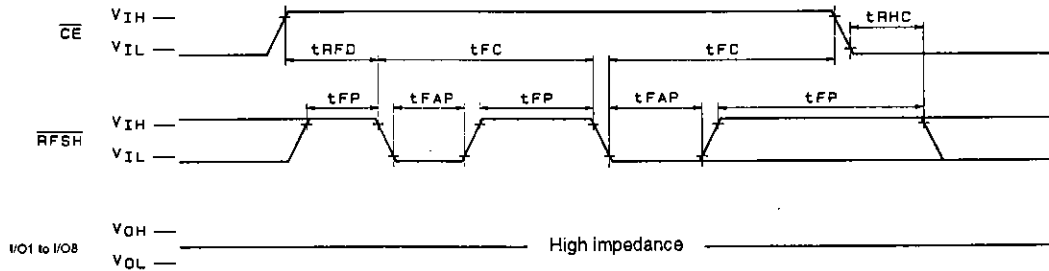

Note: CS, \overline{OE} , \overline{WE} , A0 to A16: "H" or "L"

A01939

Self-Refresh Cycle

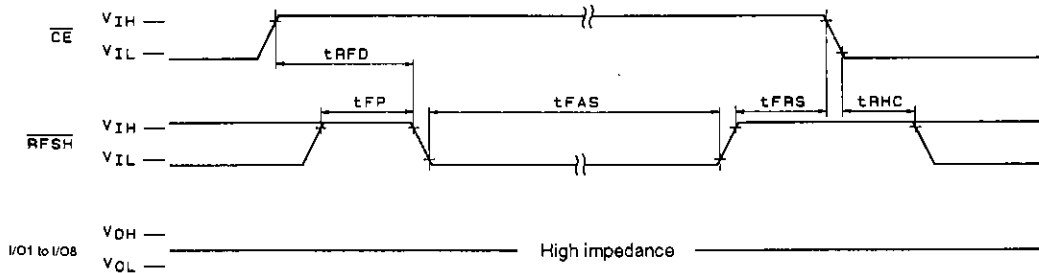

Note: CS, \overline{OE} , \overline{WE} , A0 to A16: "H" or "L"

A01940

CS Standby Mode

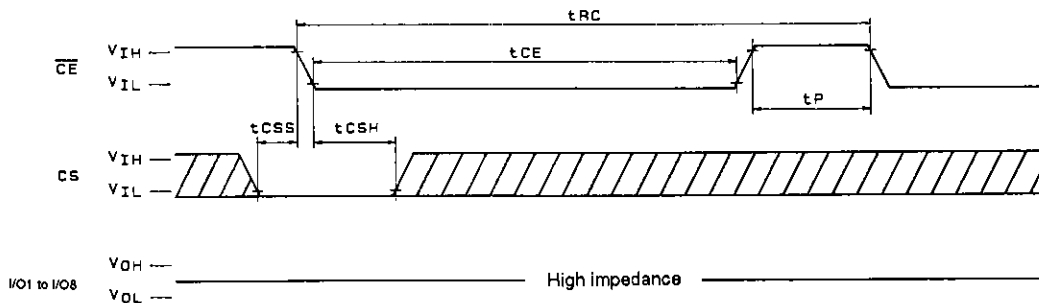

Note: \overline{OE} , \overline{WE} , A0 to A16: "H" or "L"

▨ : "H" or "L"

A01941

- No products described or contained herein are intended for use in surgical implants, life-support systems, aerospace equipment, nuclear power control systems, vehicles, disaster/crime-prevention equipment and the like, the failure of which may directly or indirectly cause injury, death or property loss.
- Anyone purchasing any products described or contained herein for an above-mentioned use shall:
 - ① Accept full responsibility and indemnify and defend SANYO ELECTRIC CO., LTD., its affiliates, subsidiaries and distributors and all their officers and employees, jointly and severally, against any and all claims and litigation and all damages, cost and expenses associated with such use:
 - ② Not impose any responsibility for any fault or negligence which may be cited in any such claim or litigation on SANYO ELECTRIC CO., LTD., its affiliates, subsidiaries and distributors or any of their officers and employees jointly or severally.
- Information (including circuit diagrams and circuit parameters) herein is for example only; it is not guaranteed for volume production. SANYO believes information herein is accurate and reliable, but no guarantees are made or implied regarding its use or any infringements of intellectual property rights or other rights of third parties.

This catalog provides information as of May, 1996. Specifications and information herein are subject to change without notice.