



LB1660N, 1661, 1664N, 1665

2-Phase Unipolar Brushless Motor Drivers

Applications

- 2-phase unipolar brushless motor (ex. DC brushless fan motor) drivers

Features and Functions

- Output current : 1.5 A
- On-chip output protect zener diodes : 60 V (LB1660N, 1664N)
- Output stage withstand voltage: 85 V (LB1661, 1665)
- On-chip hall input amplifier
- On-chip protector against lock
- With lock detect pin

Package Dimensions

unit : mm

3001B-DIP8

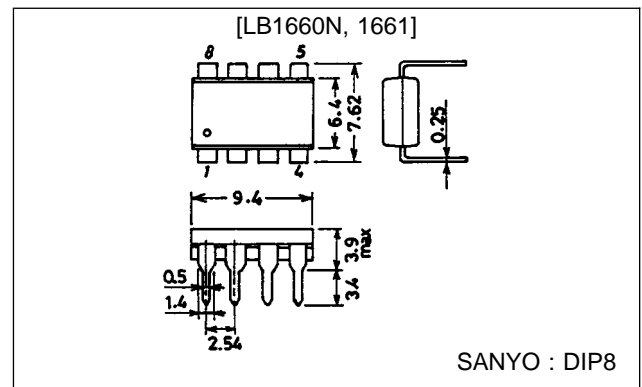

unit : mm

3054A-DIP16F

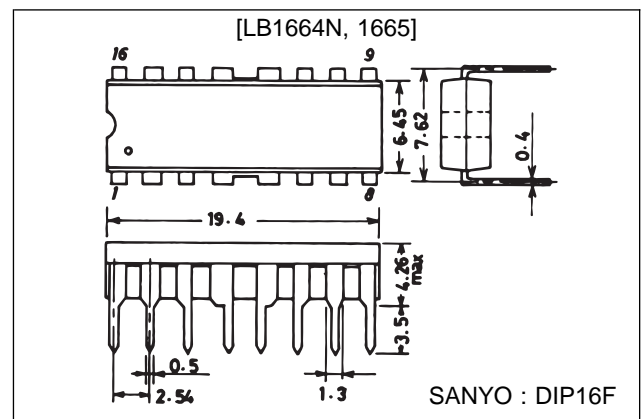

LB1660N, 1661, 1664N, 1665

Classification

The LB1660 series are classified by the package and whether the on-chip output stage zener diode is used or not, as follows.

Output stage zener diode	With ($V_Z = 59\text{ V}$)	Without ($V_{or} = 85\text{ V}$)
Package		
DIP8 ($P_d = 1.2\text{ W}$)	LB1660N	LB1661
DIP16F ($P_d = 2.0\text{ W}$)	LB1664N	LB1665

It is recommended to use the LB1661, 1665 in the following cases.

- ① A capacitor is connected across the output and GND and the back emf is more than $V_Z = 59\text{ V}$
- ② External zener diodes are connected to absorb the kickback voltage.

Pin Assignments

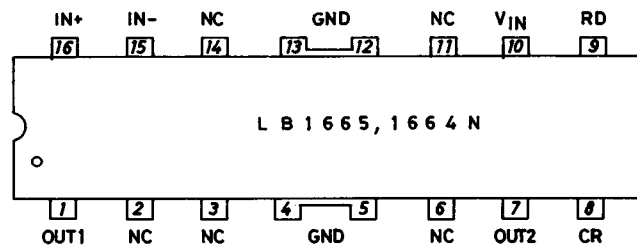
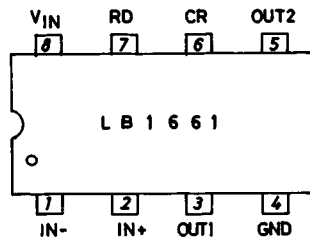
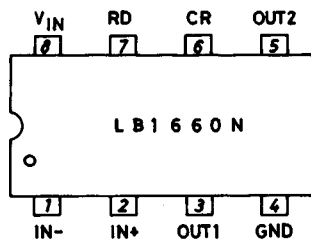

Top view

Truth Table

IN+	IN-	CR	OUT1	OUT2
H	L	L	H	L
L	H	L	L	H
H	L	H	H	H
L	H	H	H	H

LB1660N, 1661, 1664N, 1665

Equivalent Circuit Block Diagram and Sample Application Circuit

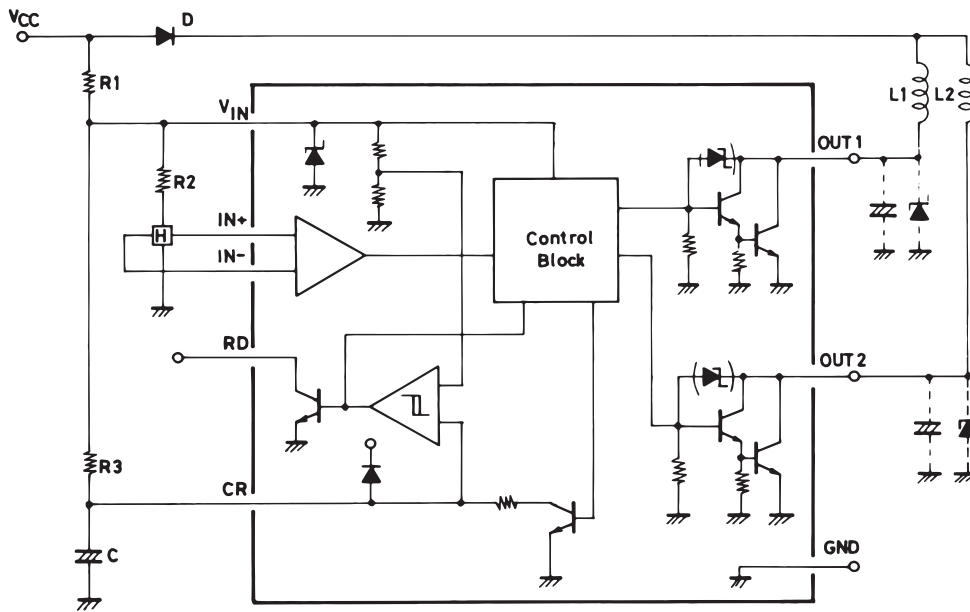

The LB1661, LB1665 have no output stage protect zener diode.

[LB1660N]

Absolute Maximum Ratings at $T_a = 25^\circ\text{C}$

Parameter	Symbol	Conditions	Ratings	Unit
Maximum input current	$I_{CC \text{ max}}$	$t \leq 20 \text{ ms}$	200	mA
Output supply voltage	$V_O \text{ max}$		Internal	V
Maximum output current	$I_O \text{ max}$		1.5	A
Output negative current	I_{OM}	$t \leq 20 \mu\text{s}$	-50	mA
RD flow-in current	I_{RD}		5	mA
RD supply voltage	V_{RD}		30	V
Allowable power dissipation	$P_d \text{ max}$		1.2	W
Operating temperature	T_{opr}		-30 to +80	$^\circ\text{C}$
Storage temperature	T_{stg}		-55 to +125	$^\circ\text{C}$

Allowable Operating Conditions at $T_a = 25^\circ\text{C}$

Parameter	Symbol	Conditions	Ratings	Unit
Input current range	I_{CC}		7.0 to 50.0	mA
Common-mode input voltage range	V_{ICM}		0 to $V_{IN}-1.5$	V

LB1660N, 1661, 1664N, 1665

Electrical Characteristics at Ta = 25°C

Parameter	Symbol	Conditions	min	typ	max	Unit
Output limit voltage	V _{OLM}	I _O = 1.0 A	56	59	63	V
Output saturation voltage	V _O (sat)1	I _O = 0.5 A		0.95	1.20	V
	V _O (sat)2	I _O = 1.0 A		1.15	1.50	V
	V _O (sat)3	I _O = 1.5 A		1.40	2.00	V
	V _{IN} input voltage	V _{IN}	I _{CC} = 7.0 mA	6.4	6.7	7.0
Amp input offset voltage	V _{off}		-7	0	+7	mV
Amp input bias current	I _{BA}		-250			nA
RD output saturation voltage	V _{RD} (sat)	I _{RD} = 5 mA			0.5	V
Comparator input bias current	I _{BC}				250	nA
Comparator input threshold voltage	V _{TH} 1		0.76	0.8V _{IN}	0.84	V
	V _{TH} 2		0.56	0.6V _{IN}	0.64	V

[LB1661]

Absolute Maximum Ratings at Ta = 25°C

Parameter	Symbol	Conditions	Ratings	Unit
Maximum input current	I _{CC} max	t ≤ 20 ms	200	mA
Output supply voltage	V _O max		-0.3 to +83	V
Maximum output current	I _O max		1.5	A
RD flow-in current	I _{RD}		5	mA
RD supply voltage	V _{RD}		20	V
Allowable power dissipation	P _d max		1.2	W
Operating temperature	T _{opr}		-30 to +80	°C
Storage temperature	T _{stg}		-55 to +125	°C

Allowable Operating Conditions at Ta = 25°C

Parameter	Symbol	Conditions	Ratings	Unit
Input current range	I _{CC}		7.0 to 50.0	mA
Common-mode input voltage range	V _{ICM}		0 to V _{IN} -1.5	V

Electrical Characteristics at Ta = 25°C

Parameter	Symbol	Conditions	min	typ	max	Unit
Output limit voltage 1	V _{OSUS}	I _O = 0.1 A, both V _{OUT} 1, 2	65			V
Output limit voltage 2	V _{OR}	I _O = 0 A, both V _{OUT} 1, 2	80			V
Output saturation voltage	V _O (sat)1	I _O = 0.5 A, both V _{OUT} 1, 2		0.95	1.20	V
	V _O (sat)2	I _O = 1.0 A, both V _{OUT} 1, 2		1.15	1.50	V
	V _O (sat)3	I _O = 1.5 A, both V _{OUT} 1, 2		1.40	2.00	V
	V _{IN} input voltage	V _{IN}	I _{CC} = 7.0 mA	6.4	6.7	7.0
Amp input offset voltage	V _{off}		-7	0	7	mV
Amp input bias current	I _{BA}		-250			nA
Comparator input bias current	I _{BC}				250	nA
Comparator input threshold voltage	V _{TH}			0.8V _{IN}		V

LB1660N, 1661, 1664N, 1665

[LB1664N]

Absolute Maximum Ratings at Ta = 25°C

Parameter	Symbol	Conditions	Ratings	Unit
Maximum input current	I _{CC} max	t ≤ 20 ms	200	mA
Output supply voltage	V _O max		Internal	V
Maximum output current	I _O max		1.5	A
Output negative current	I _{OM}	t ≤ 20 μs	-50	mA
RD flow-in current	I _{RD}		5	mA
RD supply voltage	V _{RD}		30	V
Allowable power dissipation	Pd max		2.0	W
Operating temperature	T _{opr}		-30 to +80	°C
Storage temperature	T _{stg}		-55 to +125	°C

Allowable Operating Conditions at Ta = 25°C

Parameter	Symbol	Conditions	Ratings	Unit
Input current range	I _{CC}		7.0 to 50.0	mA
Common-mode input voltage range	V _{ICM}		0 to V _{IN} -1.5	V

Electrical Characteristics at Ta = 25°C

Parameter	Symbol	Conditions	min	typ	max	Unit
Output limit voltage	V _{OLM}	I _O = 1.0 A	56	59	63	V
Output saturation voltage	V _O (sat)1	I _O = 0.5 A		0.95	1.20	V
	V _O (sat)2	I _O = 1.0 A		1.15	1.50	V
	V _O (sat)3	I _O = 1.5 A		1.40	2.00	V
	V _{IN} input voltage	V _{IN}	I _{CC} = 7.0 mA	6.4	6.7	7.0
Amp input offset voltage	V _{off}		-7	0	+7	mV
Amp input bias voltage	I _{BA}		-250			nA
RD output saturation voltage	V _{RD} (sat)	I _{RD} = 5 mA		0.2	0.5	V
Comparator input bias current	I _{BC}				250	nA
Comparator input threshold voltage	V _{TH1}		0.76	0.8V _{IN}	0.84	V
	V _{TH2}		0.56	0.6V _{IN}	0.64	V

[LB1665]

Absolute Maximum Ratings at Ta = 25°C

Parameter	Symbol	Conditions	Ratings	Unit
Maximum input current	I _{CC} max	t ≤ 20 ms	200	mA
Output supply voltage	V _O max		-0.3 to +85	V
Maximum output current	I _O max		1.5	A
RD flow-in current	I _{RD}		5	mA
RD supply voltage	V _{RD}		20	V
Allowable power dissipation	Pd max		2.0	W
Operating temperature	T _{opr}		-30 to +80	°C
Storage temperature	T _{stg}		-55 to +125	°C

Allowable Operating Conditions at Ta = 25°C

Parameter	Symbol	Conditions	Ratings	Unit
Input current range	I _{CC}		7.0 to 50.0	mA
Common-mode input voltage range	V _{ICM}		0 to V _{IN} -1.5	V

LB1660N, 1661, 1664N, 1665

Electrical Characteristics at Ta = 25°C

Parameter	Symbol	Conditions	min	typ	max	Unit
Output limit voltage 1	V _{Osus}	I _O = 0.1 A, both V _{OUT} 1, 2	65			V
Output limit voltage 2	V _{OR}	I _O = 0A, both V _{OUT} -1, 2	80			V
Output saturation voltage	V _O (sat) 1	I _O = 0.5 A, both V _{OUT} 1, 2		0.95	1.20	V
	V _O (sat) 2	I _O = 1.0 A, both V _{OUT} 1, 2		1.15	1.50	V
	V _O (sat) 3	I _O = 1.5 A, both V _{OUT} 1, 2		1.40	2.00	V
V _{IN} input voltage	V _{IN}	I _{CC} = 7.0 mA	6.4	6.7	7.0	V
Amp input offset voltage	V _{off}		-7	0	+7	mV
Amp input bias current	I _{BA}		-250			nA
Comparator input bias current	I _{BC}				250	nA
Comparator input threshold voltage	V _{TH}			0.8V _{IN}		V

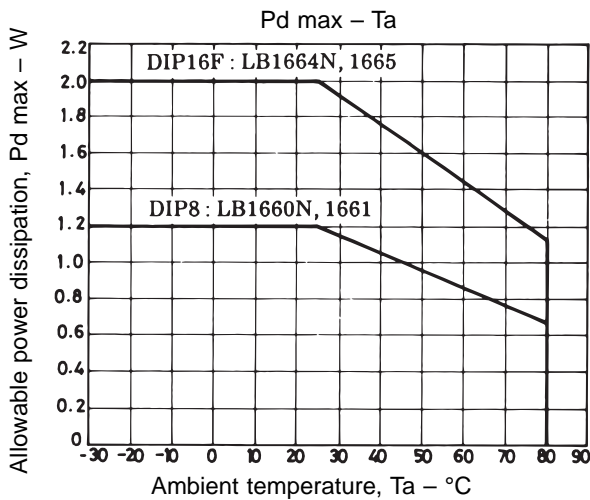

[Design Specifications]

(1) Supply voltage

The hall amp and control block of the LB1660 series are supplied with power from the on-chip parallel regulator. Set the DC resistance R1 across V_{CC} and V_{IN} so that I_{CC} flowing into the V_{IN} pin becomes 7 to 50 mA in the supply voltage range of a fan motor.

V_{IN} is 6.7 V typ at I_{CC} = 7 mA.

The current flowing into V_{IN} is calculated using the equation shown below.

$$I_{CC} = \frac{V_{CC} - V_{IN}}{R1} \dots\dots\dots ①$$

• Consideration given to surge voltage

The maximum allowable current at V_{IN} pin is 200 mA. Therefore, the design is made so that a surge voltage of positive value calculated using the following equation is allowable in applications where the IC is used.

$$V_{surge} = V_{IN} + R1 \times 200 \text{ mA} \dots\dots\dots ②$$

(2) Hall input offset voltage

The gain in transmission from the hall input pin to the output pin is 100 dB or greater. The offset voltage of the hall input amp is ±7 mV; therefore, the hall element output must be set with the offset voltage (±7 mV) considered.

(3) Output transistor

- Output Current I_O = 1.5 A max
- Output saturation voltage V_{Osat} = 2.0 V/1.5 A

When external capacitors are connected to the output stages, the capacitance should not exceed 10 μF. Since the LB1660N, 1664N have a protect zener diode across collector and base, the kickback voltage induced by the coil is cut at V_{OLM} = 59 V typ.

(4) Lock detect threshold voltage

The LB1660 series have the function to stop the output drive after the lapse of a given period of time when a motor is locked, and period of time can be set by C, R3.

The CR pin peripheral equivalent circuit is shown below. The LB1660 series generate the CR pin discharge pulse when the phase changes, (detection of rotation). When a motor is locked (very low rotational speed), the C connected to the CR pin stops discharging and the CR pin voltage rises. When the CR pin voltage exceeds the threshold voltage ($V_{IN} \times 0.8$), the output drive current becomes zero and the output transistor is turned off, and the RD pin output turns from "L" to "H". The RD pin output is of the open collector type.

CR Pin Peripheral Circuit

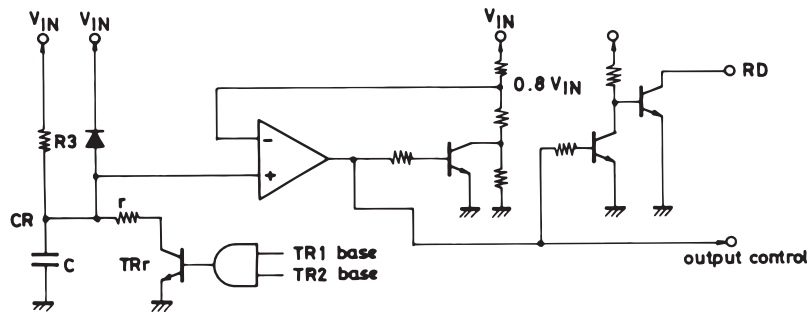
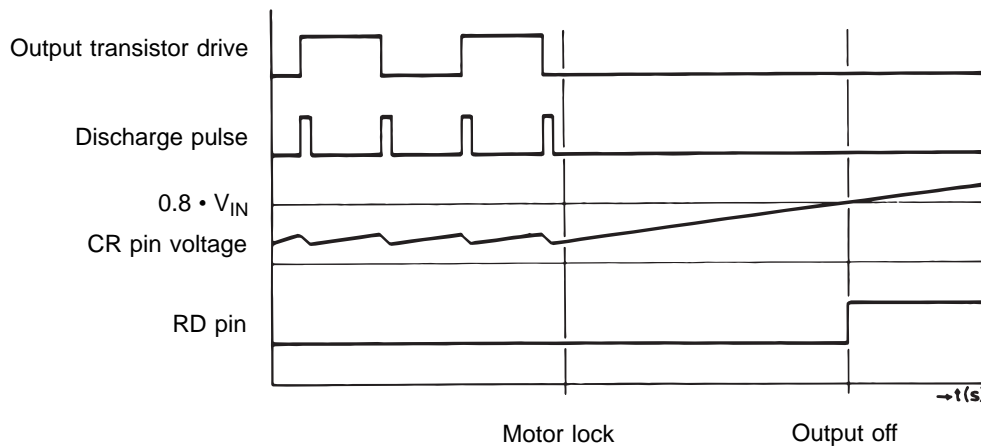

[Setting Method of Lock Detect Time]

(1) Generation of discharge pulse

Electric charges on C charged through R3 are discharged via route of $C \rightarrow r \rightarrow TRr$ with constant width pulses at each phase change. When a fan has a high rotational speed, a lot of discharge pulses are generated and the CR pin voltage ($=V_{CR}$) drops. By contrast, when a fan has a low rotational speed, V_{CR} rises and the protector is operated.

The discharge pulses are generated by two methods as shown below.

- ① Generated internally at the time of phase change. The power transistor base storage time is used for discharge pulses.
 $t = 15$ to $30 \mu\text{sec}$
- ② When the kickback voltage induced by L of a motor coil is absorbed by the zener diode across collector and base of the output transistor, this interval of time during which the transistor is turned on is used for discharge pulses.
Therefore, the LB1661,1665 or LB1660N, 1664N use external zener diodes and capacitors, discharge occurs with pulses of ① only and V_{CR} voltage gets higher than the circuit generating discharge pulses of ② even if the CR time constant is the same.

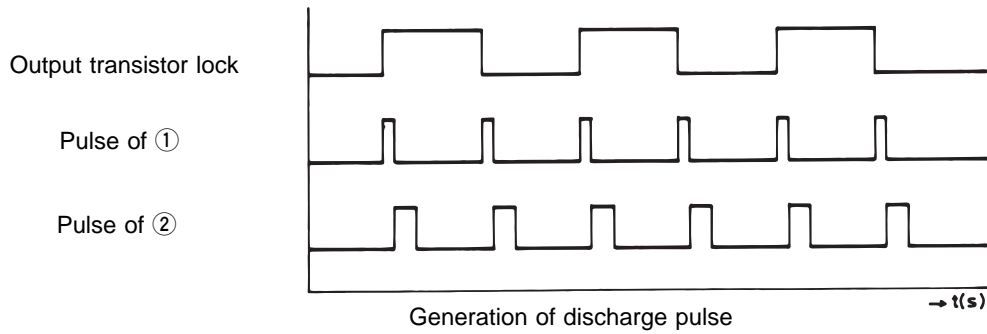

(2) CR time constant setting method

- ① Bias current of CR pin and effect of leakage of C. The value of the charge current at the threshold point is $V_{IN} \times 0.2/R3$. Therefore, this value and the leakage of C must be large enough for the bias current.
- ② The CR pin voltage must not exceed $0.6 \times V_{IN}$ (LB1660N, 1664N) or $0.8 \times V_{IN} - 0.3V$ (LB1661, 1665), until the normal rotational speed of a fan is reached and while a fan keeps the normal rotational speed; a malfunction may be caused by instantaneous drop of power supply.
- ③ It should be noted that the CR pin voltage is varied with the combination C and R, even if the CR time constant is the same.

The allowable CR setting value is given in the diagram.

(3) Restart after lock detection

The LB1660 series are so designed that when motor lock is detected and the output stage transistor is turned off the drive-off state is kept even after motor lock is released. The method of restart is shown below.

- ① Turn off the power supply and turn on again. Turn on after the V_{CR} has dropped enough.
- ② Set the CR pin voltage to be less than 1 V, and then turn off the power supply in order to cause the lock detect function to return to normal. (The CR pin can be also used to provide on-off control.)

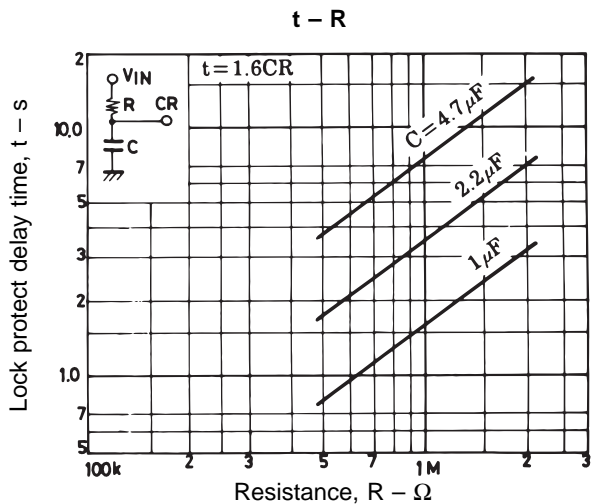
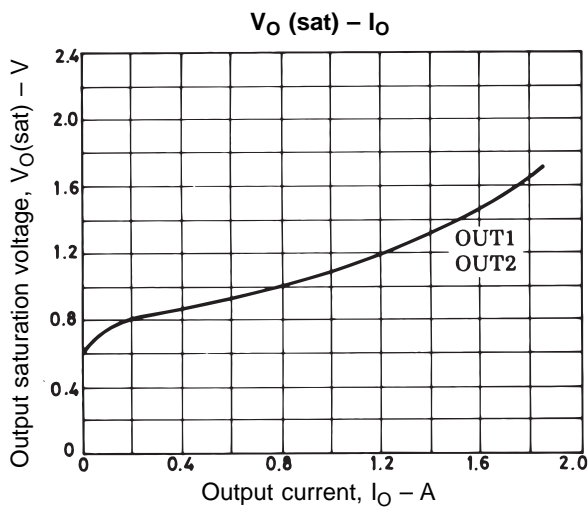
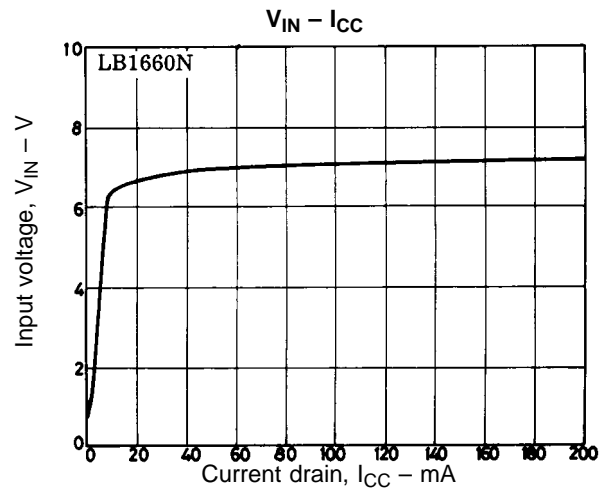

Timing Chart

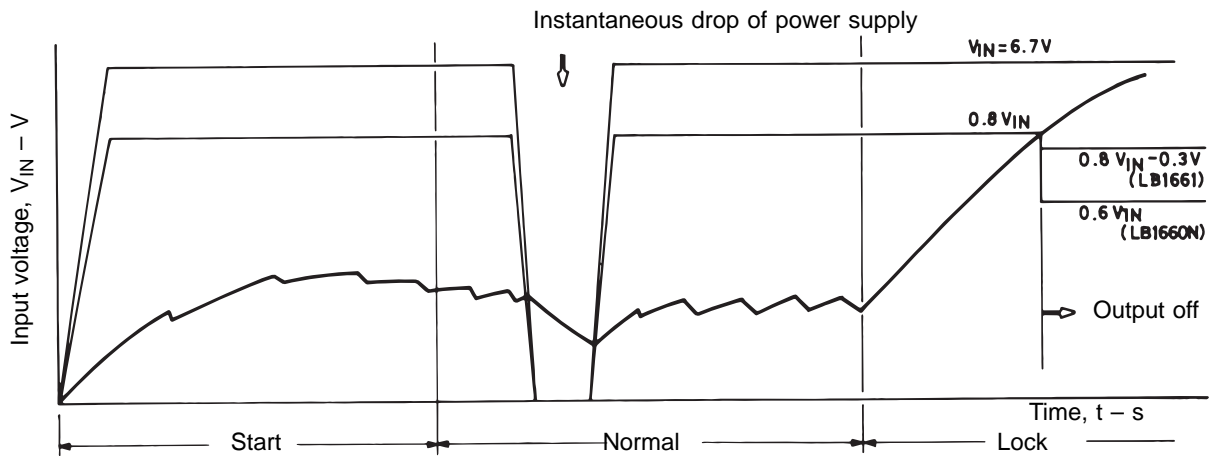

- No products described or contained herein are intended for use in surgical implants, life-support systems, aerospace equipment, nuclear power control systems, vehicles, disaster/crime-prevention equipment and the like, the failure of which may directly or indirectly cause injury, death or property loss.
- Anyone purchasing any products described or contained herein for an above-mentioned use shall:
 - ① Accept full responsibility and indemnify and defend SANYO ELECTRIC CO., LTD., its affiliates, subsidiaries and distributors and all their officers and employees, jointly and severally, against any and all claims and litigation and all damages, cost and expenses associated with such use:
 - ② Not impose any responsibility for any fault or negligence which may be cited in any such claim or litigation on SANYO ELECTRIC CO., LTD., its affiliates, subsidiaries and distributors or any of their officers and employees jointly or severally.
- Information (including circuit diagrams and circuit parameters) herein is for example only; it is not guaranteed for volume production. SANYO believes information herein is accurate and reliable, but no guarantees are made or implied regarding its use or any infringements of intellectual property rights or other rights of third parties.

This catalog provides information as of October, 1996. Specifications and information herein are subject to change without notice.