

**LB1648****Dual Bidirectional Motor Driver****Overview**

The LB1648 is a dual bidirectional motor driver. It is especially suited for reel motor in cassette deck.

**Features**

- 2-input logic can be used to exercise control of bidirectional driving, braking and open.
- Output voltage variable by use of external Zener diode.
- On-chip thermal protector.

**Package Dimensions**

unit:mm

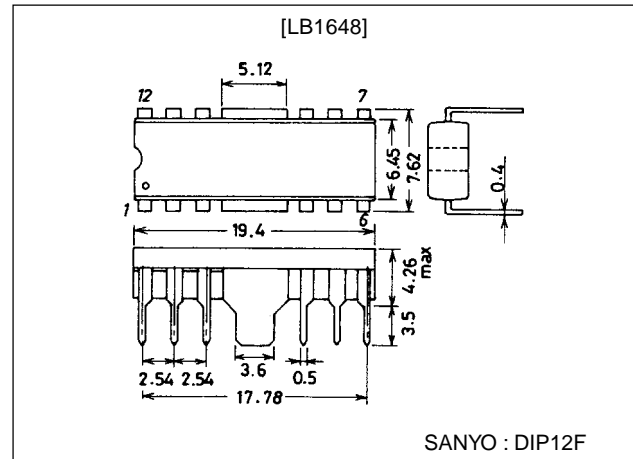
**3022A-DIP12F****Specifications****Absolute Maximum Ratings at Ta = 25°C**

Parameter	Symbol	Conditions	Ratings	Unit
Maximum supply voltage	$V_{CC \text{ max}}$		18	V
Input voltage	$V_{IN}$		18	V
Output current	$I_O$		$\pm 0.8$	A
Allowable power dissipation	$P_d \text{ max}$		1.9	W
Operating temperature	$T_{opr}$		-25 to +75	°C
Storage temperature	$T_{stg}$		-55 to +125	°C

**Allowable Operating Conditions at Ta = 25°C**

Parameter	Symbol	Conditions	Ratings	Unit
Supply voltage	$V_{CC}$		7 to +16	V

- Any and all SANYO products described or contained herein do not have specifications that can handle applications that require extremely high levels of reliability, such as life-support systems, aircraft's control systems, or other applications whose failure can be reasonably expected to result in serious physical and/or material damage. Consult with your SANYO representative nearest you before using any SANYO products described or contained herein in such applications.
- SANYO assumes no responsibility for equipment failures that result from using products at values that exceed, even momentarily, rated values (such as maximum ratings, operating condition ranges, or other parameters) listed in products specifications of any and all SANYO products described or contained herein.

**SANYO Electric Co., Ltd. Semiconductor Business Headquarters**

TOKYO OFFICE Tokyo Bldg., 1-10, 1 Chome, Ueno, Taito-ku, TOKYO, 110-8534 JAPAN

82098HA (KT)/7310TS/1220TA, TS No.3221-1/7

# LB1648

## Electrical Characteristics at $T_a = 25^\circ\text{C}$ , $V_{CC}=12\text{V}$ , per channel

Parameter	Symbol	Conditions	Ratings			Unit
			min	typ	max	
Current drain	$I_{CC1}$	Pin 1 forward, $R_L=\infty$ , $V_Z=4\text{V}$		15	22	mA
	$I_{CC2}$	Pin 7 forward, $R_L=\infty$ , $V_Z=4\text{V}$		14	20	mA
	$I_{CC3}$	Pin 7 open, $R_L=\infty$		1.5	3	mA
Output leakage current	$I_{OL}$	Braking mode, $R_L=\infty$ , per output pin		40	120	$\mu\text{A}$
Input threshold voltage	$V_{th}$	$R_L=\infty$	0.9	1.05	1.20	V
Output voltage	$V_O$	$V_Z=4\text{V}$ , $I_{OUT}=85\text{mA}$	3.75	4.0	4.25	V
Output transistor saturation voltage (upper)	$V_{sat1}$	$I_{OUT}=200\text{mA}$		1.9	2.3	V
		$I_{OUT}=400\text{mA}$		2.0	2.4	V
Output transistor saturation voltage (lower)	$V_{sat2}$	$I_{OUT}=200\text{mA}$		0.3	0.55	V
		$I_{OUT}=400\text{mA}$		0.5	0.7	V
$V_Z$ pin flow-out current	$I_Z$	$V_Z=4\text{V}$ , $I_{OUT}=0\text{mA}$	0.55	0.85	1.15	mA

## Equivalent Circuit Block Diagram

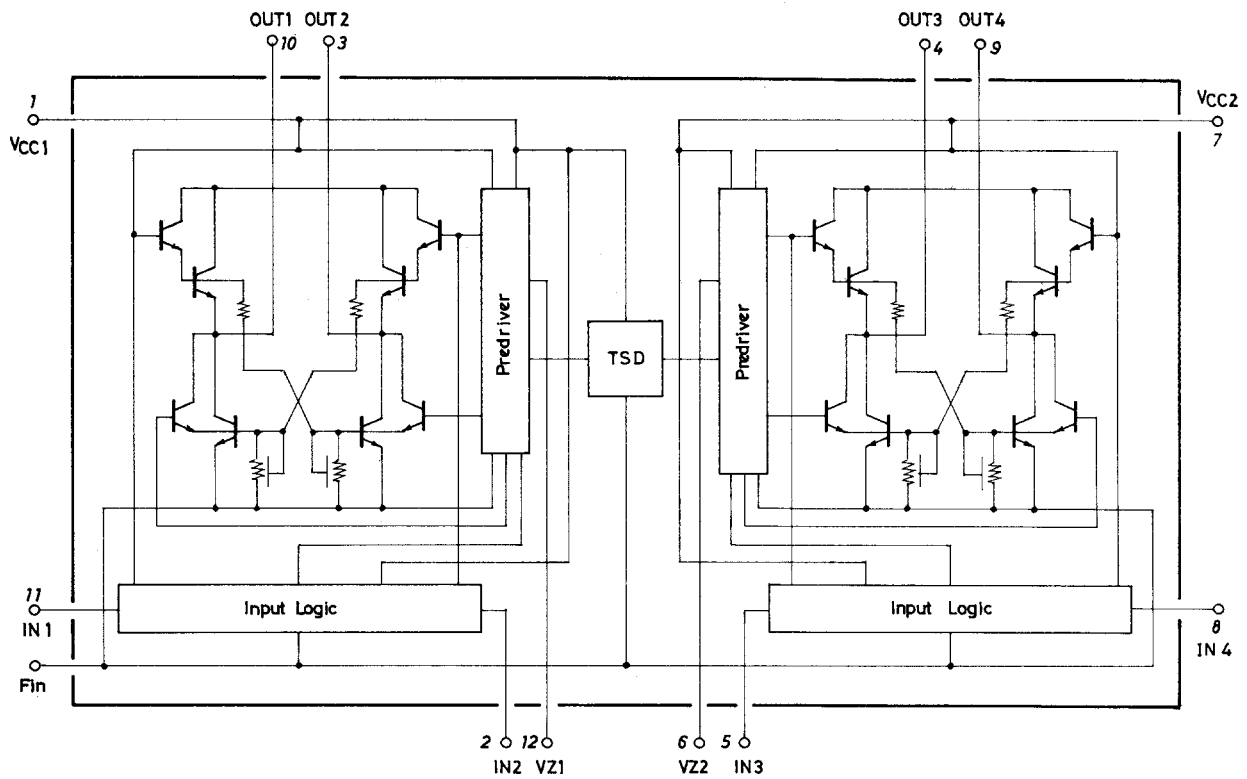

## Logic Section Truth Table

Mode	IN1	IN2	OUT1	OUT2	IN3	IN4	OUT3	OUT4
Open	0	0	Open	Open	0	0	Open	Open
Forward	1	0	H	L	1	0	H	L
Reverse	0	1	L	H	0	1	L	H
Brake	1	1	L	L	1	1	L	L

Note : A capacitor of  $0.01\mu\text{F}$  or greater must be connected across  $V_{CC1, 2}$  and GND

# LB1648

## Sample Application Circuit

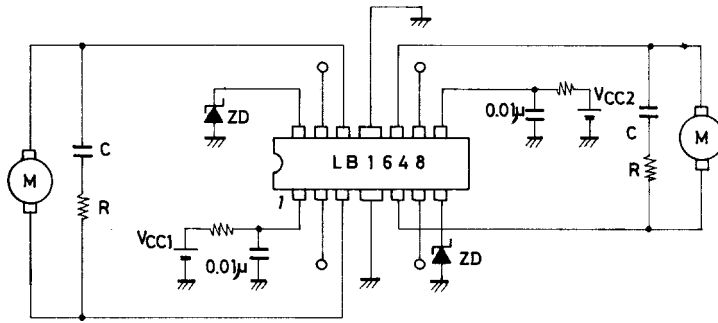

Unit (capacitance: F)

## Test Circuit (1channel)

- (1)  $I_{CC1}$  (pin 1)
- $I_{CC2}$  (pin 7)
- $I_{CC3}$  (pin 7)

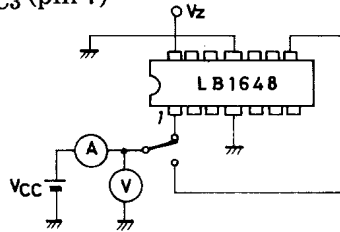

- (2)  $I_{OL}$

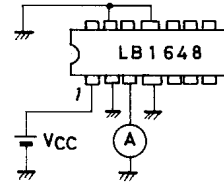

- (3)  $V_{th}$

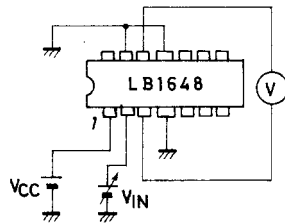

- (4)  $V_o$

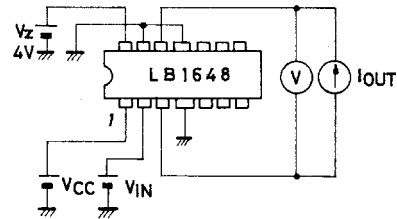

- (5)  $V_{sat1}$

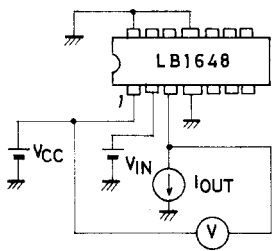

- (6)  $V_{sat2}$

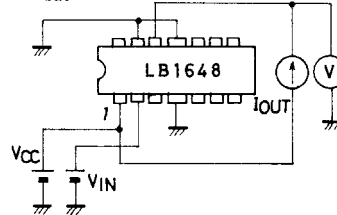

# LB1648

## Internal Circuits Input Circuit

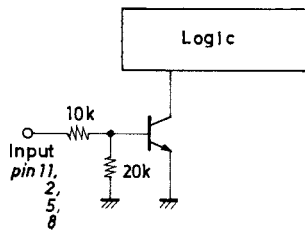

Resistance variations (including temperature characteristics)  
- 35 to +50%

Unit (resistance:  $\Omega$ )

## Output Circuit

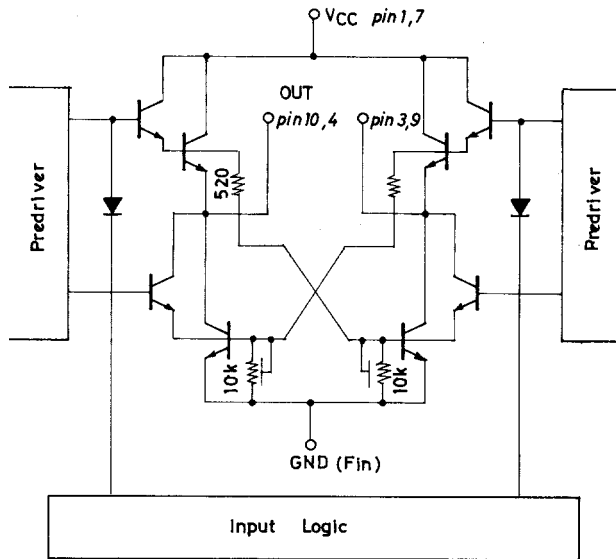

Unit (resistance:  $\Omega$ )

## Circuit of Pin Vz

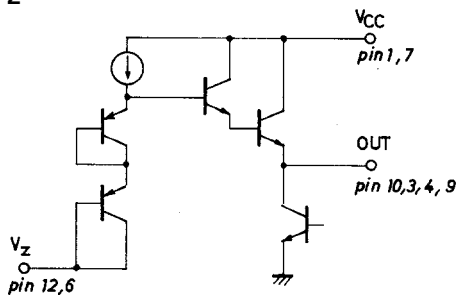

$V_{BE}$  of 2 output NPN transistors  
is canceled by  $V_{BE}$  of 2 PNP transistors.

$$V_o \approx V_Z$$

**Design Notes**

1 : Maximum voltage, maximum current

A voltage greater than the supply voltage, 7 to 16V, specified in the Allowable Operating Conditions must not be applied to pins 1 and 7. The maximum current is 0.8A (peak). The rush current at the time of start must not exceed the peak current.

2 : Output transistor protection

A resistor (or for fuse resistor) must be connected to the  $V_{CC}$  line to provide protection against output short, output pin-to-GND short.

3 : Wiring

The bypass capacitors connected across pins 1, 7 and GND must not have an impedance common to other lines, The GND line must be separated from other circuits.

4 : Provision against oscillation

In applications where motors with brush are used, a capacitor may be connectd across both terminals to prevent the spark-caused noise. This capacitor is connected across the output pins of the LB1648, which may cause oscillation to occur. In this case, the capacitor value must be made as small as possible or a resistor must be connected in series.

5 : External Zener diode

The current flowing out of the  $V_Z$  pin varies with the load and its maximum value is approximately 1.2mA.

If you use a Zener diode of soft clip type and need an accuracy in voltage, a current required for the Zener diode must be supplied externally.

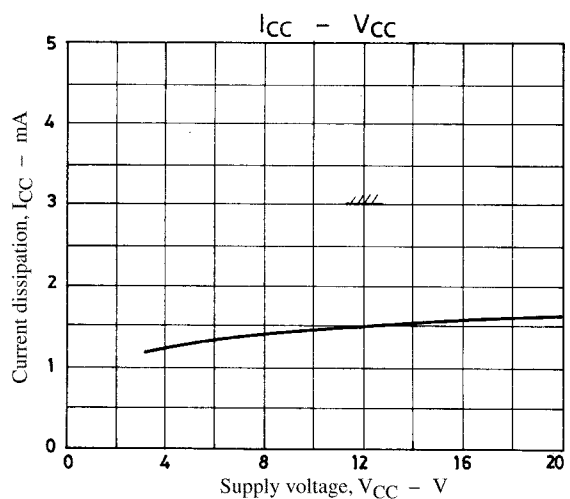
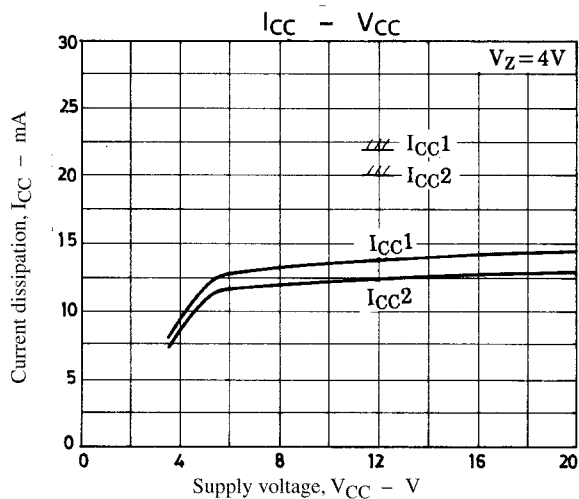
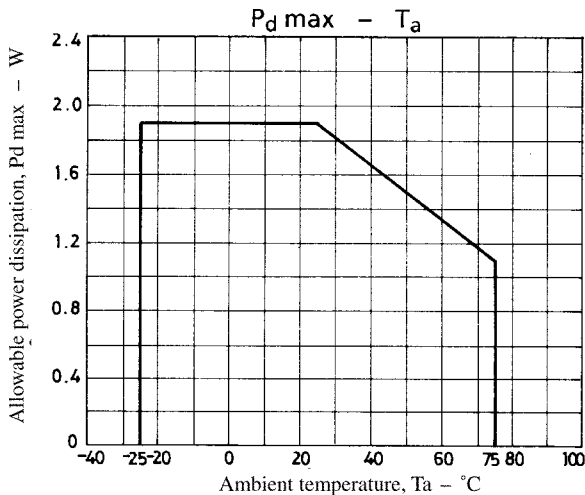
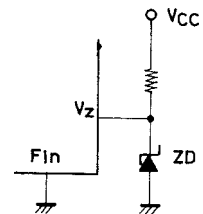
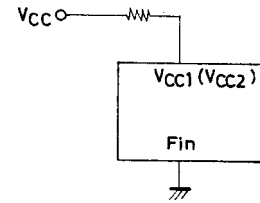

# LB1648

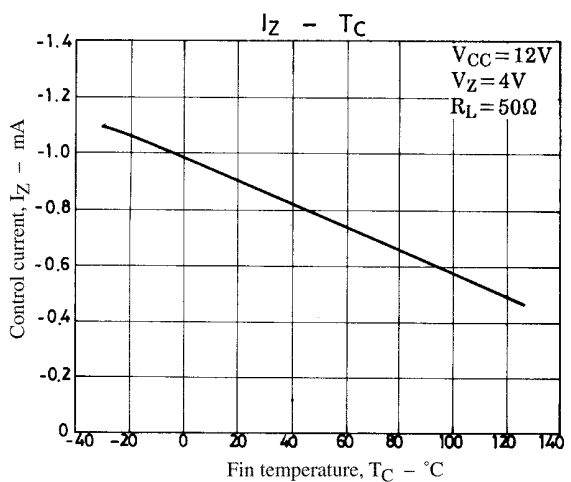
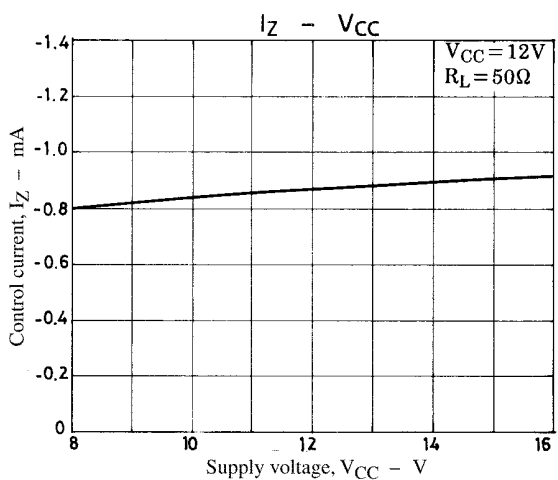
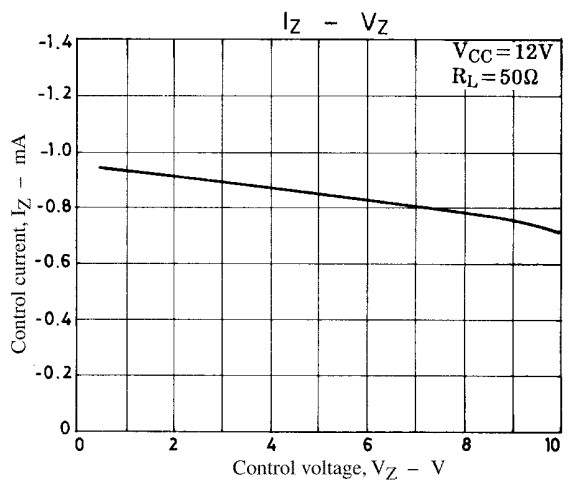
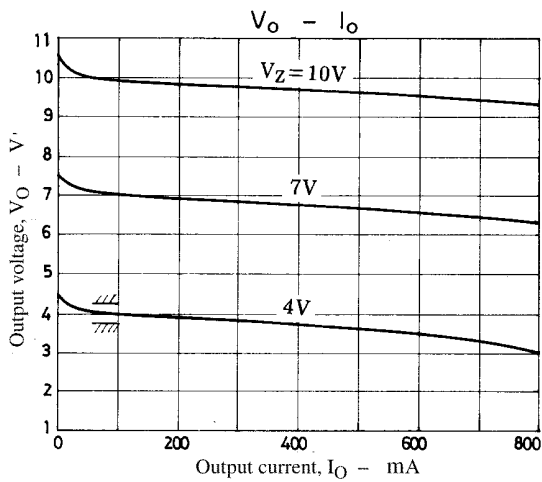
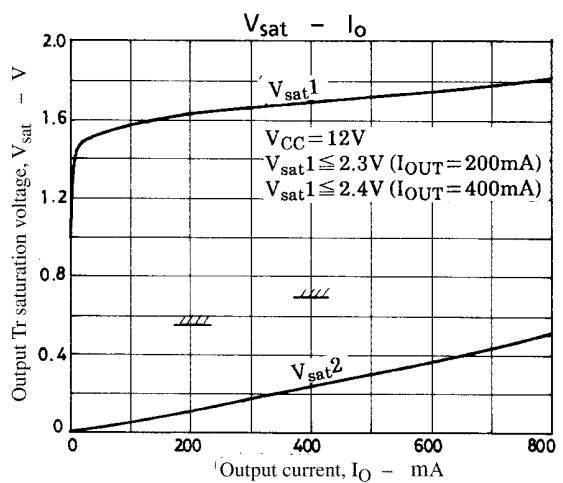
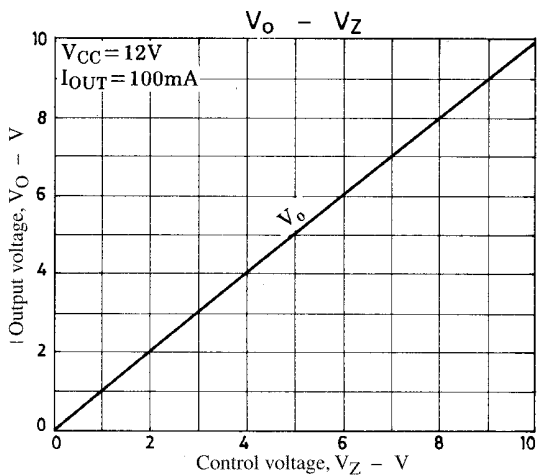
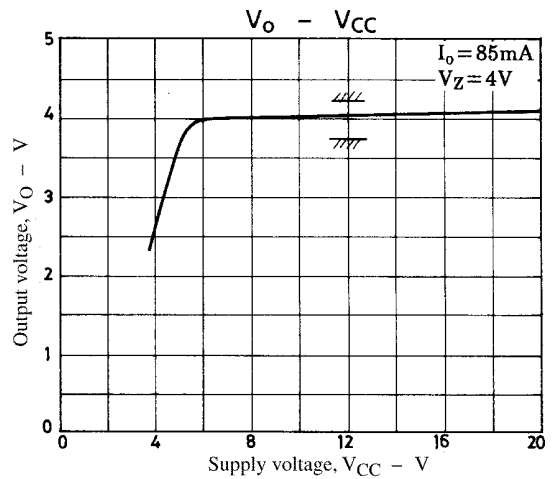
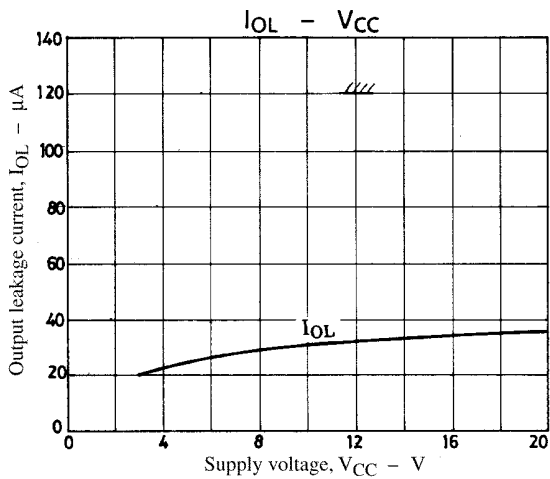

- Specifications of any and all SANYO products described or contained herein stipulate the performance, characteristics, and functions of the described products in the independent state, and are not guarantees of the performance, characteristics, and functions of the described products as mounted in the customer's products or equipment. To verify symptoms and states that cannot be evaluated in an independent device, the customer should always evaluate and test devices mounted in the customer's products or equipment.
- SANYO Electric Co., Ltd. strives to supply high-quality high-reliability products. However, any and all semiconductor products fail with some probability. It is possible that these probabilistic failures could give rise to accidents or events that could endanger human lives, that could give rise to smoke or fire, or that could cause damage to other property. When designing equipment, adopt safety measures so that these kinds of accidents or events cannot occur. Such measures include but are not limited to protective circuits and error prevention circuits for safe design, redundant design, and structural design.
- In the event that any and all SANYO products described or contained herein fall under strategic products (including services) controlled under the Foreign Exchange and Foreign Trade Control Law of Japan, such products must not be exported without obtaining export license from the Ministry of International Trade and Industry in accordance with the above law.
- No part of this publication may be reproduced or transmitted in any form or by any means, electronic or mechanical, including photocopying and recording, or any information storage or retrieval system, or otherwise, without the prior written permission of SANYO Electric Co., Ltd.
- Any and all information described or contained herein are subject to change without notice due to product/technology improvement, etc. When designing equipment, refer to the "Delivery Specification" for the SANYO product that you intend to use.
- Information (including circuit diagrams and circuit parameters) herein is for example only ; it is not guaranteed for volume production. SANYO believes information herein is accurate and reliable, but no guarantees are made or implied regarding its use or any infringements of intellectual property rights or other rights of third parties.

This catalog provides information as of August, 1998. Specifications and information herein are subject to change without notice.