

SANYO

NO.266E

LB1287,1288

Darlington Transistor Array

These ICs have circuit configuration of 5-unit Darlington transistor array consisting of NPN transistors and are capable of causing small input current to provide large current drive. They can be advantageously incorporated in equipment because the specially designed 14-pin DIP makes such equipment more compact.

Features

- . Large maximum drive current. 400mA
- . Large allowable power dissipation. 1.15W
- . Wide range of operating supply voltage. LB1287 5 to 30V, LB1288 5 to 20V
- . Wide range of operating temperature. -20 to +80°C
- . Large current-amplification factor. 2000 or more

Applications

- . Various types of driver (relay, solenoid, motor, etc.).
- . Display segment or digit driver (LED, lamp).
- . Interface to MOS or bipolar logic IC.
- . Power amplification of pulse (fan-out extension, etc.).

Absolute Maximum Ratings at $T_a=25^\circ\text{C}$

				unit
Collector-Base Voltage	V_{CB0}	[LB1287]	30	V
		[LB1288]	20	V
Collector-Emitter Voltage	V_{CE0^*}	[LB1287]	-0.7 to +30	V
		[LB1288]	-0.7 to +20	V
Allowable Power Dissipation	P_{Dmax}		1.15	W
Input Voltage	V_{in}	Per unit	-0.7 to +45	V
Collector Current	I_C	Per unit	500	mA
Junction Temperature	T_j		125	°C
Operating Temperature	T_{opr}		-20 to +80	°C
Storage Temperature	T_{stg}		-40 to +125	°C

* : The substrate is connected to emitter.

Equivalent Circuit

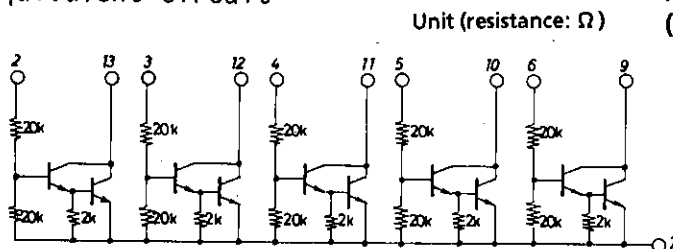

Note 1. Pins 1, 8, 14 : NC
 Note 2. The substrate is connected to pin 7.

Package Dimensions 3004A-D14TKIC
 (unit : mm)

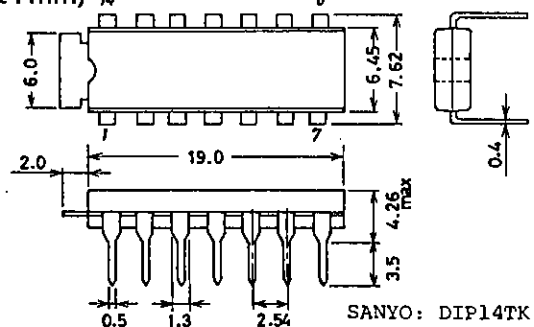

SANYO Electric Co., Ltd. Semiconductor Business Headquarters
 TOKYO OFFICE Tokyo Bldg., 1-10, 1 Chome, Ueno, Taito-ku, TOKYO, 110 JAPAN

Allowable Operating Conditions at $T_a=25^\circ\text{C}$

Parameter	Symbol	Value	unit
Supply Voltage	V_{CC}	[LB1287] [LB1288]	5 to 30 5 to 20 V
Collector Current	$I_{COP}(1)$	Turning ON 5 units simultaneously, $T_a=80^\circ\text{C}$, 20% duty	280 mA
	$I_{COP}(2)$	Turning ON 5 units simultaneously, $T_a=80^\circ\text{C}$ 50% duty	150 mA
	$I_{COP}(3)$	Turning ON 5 units simultaneously, $T_a=80^\circ\text{C}$, DC	100 mA

Electrical Characteristics at $T_a=25^\circ\text{C}$

Parameter	Symbol	Test Condition	Test circuit	min	typ	max	unit
Collector-Base Voltage	V_{CBO}	$I_C=50\mu\text{A}$	[LB1287] [LB1288]	A	30		V
Collector-Emitter Voltage	V_{CEO}	$I_C=100\mu\text{A}$	[LB1287] [LB1288]	B	30		V
DC Current Gain	h_{FE}	$V_{CE}=5\text{V}, I_C=200\text{mA}$	C	2000			
Collector-Emitter Saturation Voltage	$V_{CE(sat)}$	$V_{in}=12\text{V}, I_C=400\text{mA}$ $V_{in}=9.5\text{V}, I_C=300\text{mA}$ $V_{in}=7.0\text{V}, I_C=200\text{mA}$	D			2.3 1.8 1.4	V
Input Current	I_{in}	$V_{in}=17\text{V}$	E		0.8		mA

Test Circuit

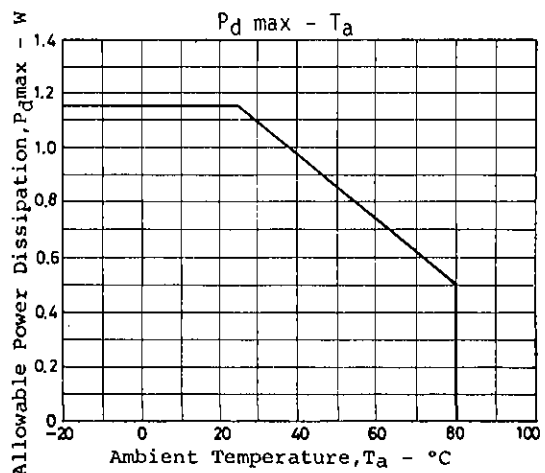
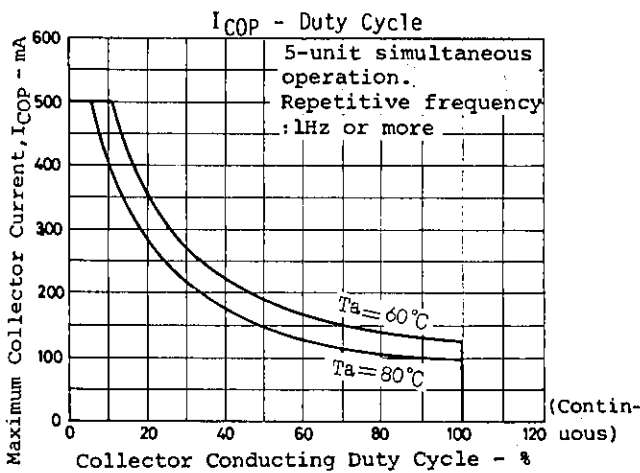
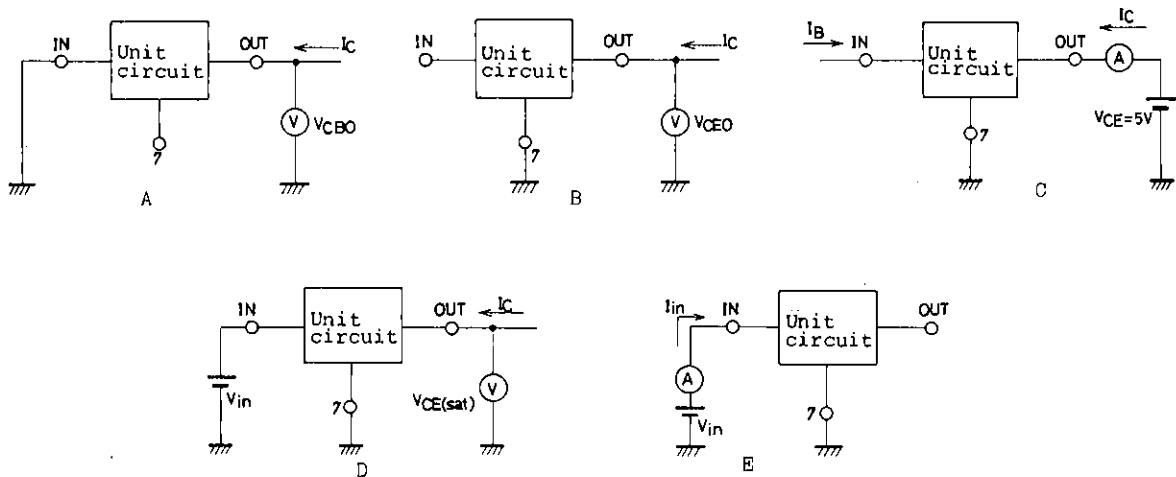

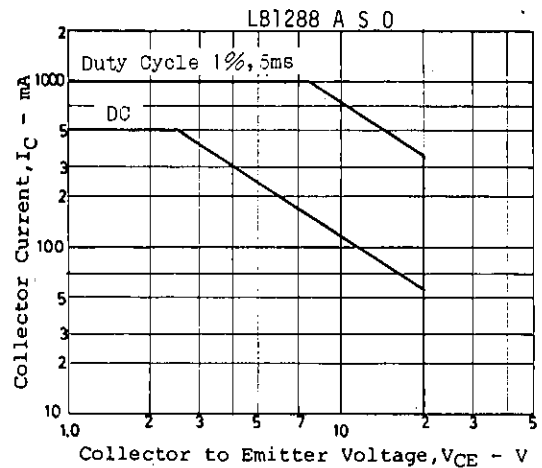
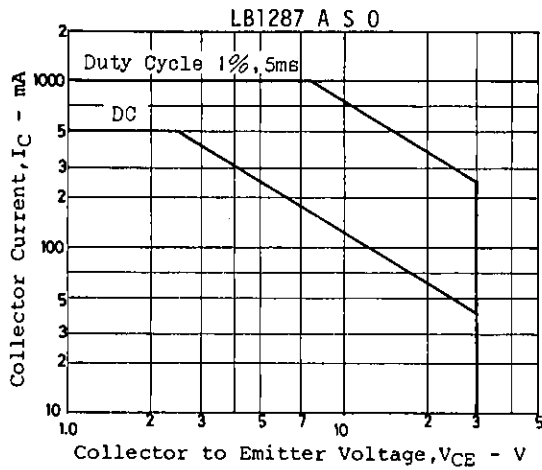

■ No products described or contained herein are intended for use in surgical implants, life-support systems, aerospace equipment, nuclear power control systems, vehicles, disaster/crime-prevention equipment and the like, the failure of which may directly or indirectly cause injury, death or property loss.

■ Anyone purchasing any products described or contained herein for an above-mentioned use shall:

- ① Accept full responsibility and indemnify and defend SANYO ELECTRIC CO., LTD., its affiliates, subsidiaries and distributors and all their officers and employees, jointly and severally, against any and all claims and litigation and all damages, cost and expenses associated with such use;
- ② Not impose any responsibility for any fault or negligence which may be cited in any such claim or litigation on SANYO ELECTRIC CO., LTD., its affiliates, subsidiaries and distributors or any of their officers and employees jointly or severally.

■ Information (including circuit diagrams and circuit parameters) herein is for example only; it is not guaranteed for volume production. SANYO believes information herein is accurate and reliable, but no guarantees are made or implied regarding its use or any infringements of intellectual property rights or other rights of third parties.