

SANYO

No.2713A

Audio Controller for TV Use

Overview

The LA7953 Audio Controller is a single-chip, linear IC featuring a built-in expansion circuit. The device also features a 4-input 1-output audio switch, an acoustic mute, a LINE-OUT output, and audio control functions for volume, balance, bass and treble on-chip.

Excellent audio reproduction can be obtained using the right channel expansion circuit.

The LA7953 operates on a single 12V power supply and is available in 30-pin plastic DIPs.

Functions

- One-chip audio controller and audio switch facilitate design
- Audio controller for volume, balance, bass and treble
- 4-input/1-output audio switch
- On-chip expansion circuit ensures excellent sound reproduction
- LINE-OUT output
- Acoustic mute

Specifications

Maximum Ratings at $T_a = 25^\circ\text{C}$

Parameter	Symbol	Conditions	Ratings	Unit
Maximum supply voltage	$V_{CC \text{ max}}$		14	V
Input applied voltage 1	$V_{1,3,5,7,9,11,13,15 \text{ max}}$	$V_{CC} = 14\text{V}$	12	V
Input applied voltage 2	$V_{2,14,16,30 \text{ max}}$	$V_{CC} = 14\text{V}$	14	V
Input applied voltage 3	$V_4 \text{ max}, V_6 \text{ max}$	$V_{CC} = 14\text{V}$	14	V
Mute input applied voltage	$V_8 \text{ max}$	$V_{CC} = 14\text{V}$	14	V
Expansion input applied voltage	$V_{12 \text{ max}}$	$V_{CC} = 14\text{V}$	14	V
LINE-OUT output current	$I_{17,29 \text{ max}}$		5	mA
Maximum output current	$I_{23,25 \text{ max}}$		5	mA
Expansion output current	$I_{19 \text{ max}}$		5	mA
Tone control input applied voltage	$V_{20 \text{ max}}, V_{28 \text{ max}}$	$V_{CC} = 14\text{V}$	14	V
Bass filter applied voltage	$V_{22 \text{ max}}, V_{26 \text{ max}}$	$V_{CC} = 14\text{V}$	14	V
Treble filter applied voltage	$V_{21 \text{ max}}, V_{27 \text{ max}}$	$V_{CC} = 14\text{V}$	14	V
Expansion filter applied voltage	$V_{18 \text{ max}}$	$V_{CC} = 14\text{V}$	12	V
Allowable power dissipation	$P_d \text{ max}$	$T_a \leq 65^\circ\text{C}$	1100	mW
Operating temperature	T_{opr}		-20 to +65	$^\circ\text{C}$
Storage temperature	T_{stg}		-55 to +150	$^\circ\text{C}$

Package Dimensions

unit: mm
3061-DIP30S

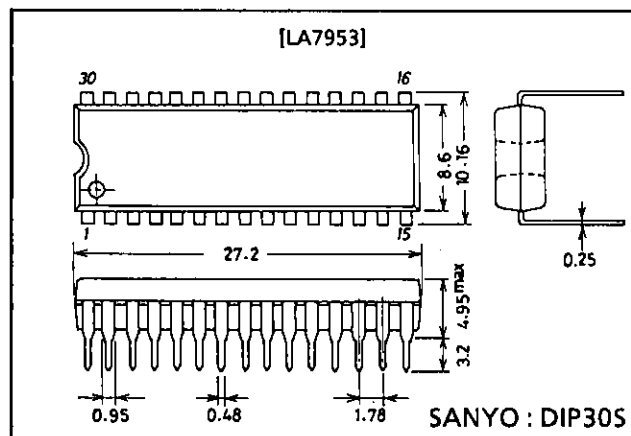

Operating Conditions at $T_a = 25^\circ\text{C}$

Parameter	Symbol	Conditions	Ratings	Unit
Recommended supply voltage	V_{CC}		12	V
Operating voltage range	$V_{CC\text{ OP}}$		10.5 to 13.2	V

Operating Characteristics at $T_a = 25^\circ\text{C}$, $V_{CC} = 12\text{V}$

Parameter	Symbol	Conditions	Test Circuit	min	typ	max	Unit
[Audio SW]							
Input bias voltage	$V_{1,3,5,7}$ $V_{9,11,13,15}$		1	4.4	5.3	6.2	V
LINE-OUT output bias voltage	$V_{17,29}$	S4,S5 = H	1	2.1	3.0	3.9	V
LINE-OUT output DC offset voltage	V_{OS}	Differential voltage when LINE-OUT output is switched.	1	-100	0	+100	mV
Control threshold voltage	V_{4H}, V_{6H}		2	3.0			V
Control threshold voltage	V_{4L}, V_{6L}		2			1.5	V
LINE-OUT voltage gain	G_{LV}	$V_{IN} = 500\text{mVrms}$, $f = 1\text{kHz}$	2	-1	0	+1	dB
LINE-OUT distortion ratio	THD_L	$V_{IN} = 500\text{mVrms}$, $f = 100\text{Hz}, 1\text{kHz}$, L.P.F. = 80kHz	2		0.05	0.2	%
LINE-OUT noise	V_{NL}	$R_g = 600\Omega$, 15kHz band	2		10	30	μVrms
Mute input threshold voltage	V_{8TH}		2	3.0			V
Mute input threshold voltage	V_{8TL}					1.5	V
Input impedance	$Z_{1,3,5,7,9,11,13,15}$		1	47	68	89	$k\Omega$
LINE-OUT output impedance	$Z_{17,29}$		1		50	150	Ω
[Audio Control]							
Quiescent current drain (Including audio switch)	I_{CC}		1	35	45	65	mA
Output bias voltage	V_{23}, V_{25}	$V_{30} = 12\text{V}, V_2 = V_{14} = V_{16} = 6\text{V}$	1	4	5.5	7	V
Left&Right channel output DC offset	$V_{23\text{ to }25}$	$V_{30} = 12\text{V}, V_2 = V_{14} = V_{16} = 6\text{V}$	1	-2	0.2	+2	V
Output voltage	V_O	$V_{IN} = 500\text{mVrms}$, $f = 1\text{kHz}$, $V_{30} = 12\text{V}, V_2 = V_{14} = V_{16} = 6\text{V}$	2	390	450	630	mVrms
Channel balance	G_{Ba}	$V_{IN} = 500\text{mVrms}$, $f = 1\text{kHz}$, $V_{30} = 12\text{V}, V_2 = V_{14} = V_{16} = 6\text{V}$	2	-1	0.4	+1	dB
Dynamic range	THD_D	$V_{IN} = 0.8\text{mVrms}$, $f = 40\text{Hz}$, 15kHz, L.P.F = 80kHz, $V_{30} = 12\text{V}, V_2 = V_{14} = V_{16} = 6\text{V}$	2		0.25	2	%
Left&Right channel attenuation	A_{TT}	$V_{OUT} = 500\text{mVrms}$ (0dB), $f = 1\text{kHz}$, $V_{30} = 0\text{V}, V_2 = V_{14} = V_{16} = 6\text{V}$	2	65	72		dB
Bass control, boost	GB_{BOOST}	$V_{OUT} = 500\text{mVrms}$ (1k), $f = 40\text{Hz}$, $V_{30} = V_{14} = 12\text{V}, V_2 = V_{16} = 6\text{V}$	2	7	9	12	dB
Bass control, cut	GB_{CUT}	$V_{OUT} = 500\text{mVrms}$ (1k), $f = 40\text{Hz}$, $V_{30} = 12\text{V}, V_{14} = 0\text{V}, V_2 = V_{16} = 6\text{V}$	2	-1.3	-9	-6.5	dB
Treble control, boost	GB_{BOOST}	$V_{OUT} = 500\text{mVrms}$ (1k), $f = 15\text{kHz}$, $V_{30} = V_{11} = 12\text{V}, V_2 = V_{14} = 6\text{V}$	2	6.5	9	13	dB
Treble control, cut	GT_{CUT}	$V_{OUT} = 500\text{mVrms}$ (1k), $f = 15\text{kHz}$, $V_{30} = 12\text{V}, V_{14} = 0\text{V}, V_2 = V_{16} = 6\text{V}$	2	-18	-9	-6.5	dB

Continued on next page.

Continued from preceding page.

Parameter	Symbol	Conditions	Test Circuit	min	typ	max	Unit
Balance control	ATT _{BR}	V _{OUT} = 500mVrms (0dB), f = 1kHz, V ₃₀ = 12V, V ₂ = 0V, V ₁₄ = V ₁₆ = 6V	2		-55	-40	dB
Balance control	ATT _{BL}	V _{OUT} = 500mVrms (0dB), f = 1kHz, V ₃₀ = V ₂ = 12V, V ₁₄ = V ₁₆ = 6V	2		-55	-40	dB
Crosstalk	CT	V _{OUT} = 500mVrms (0dB), f = 1kHz, V ₃₀ = 12V, V ₂ = V ₁₄ = V ₁₆ = 6V	2	65	80		dB
Noise	V _N	15kHz band, V ₃₀ = 12V, V ₂ = V ₁₄ = V ₁₆ = 6V	2		80	240	μVrms
Total harmonic distortion	THD	V _{IN} = 500mVrms, f = 1kHz, L.P.F. = 80kHz, V ₃₀ = 12V, V ₂ = V ₁₄ = V ₁₆ = 6V	2		0.2	0.5	%
Expansion characteristics	P _{EXP}	V _{IN} = 500mVrms, f = 1kHz, C = 0.047μ, V ₃₀ = 12V, V ₂ = V ₁₄ = V ₁₆ = 6V	2	125	145	165	deg
Expansion characteristics	G _{EXP}	V _{IN} = 500mVrms, f = 1kHz, C = 0.047μ, V ₃₀ = 12V, V ₂ = V ₁₄ = V ₁₆ = 6V	2	-1	0	+1	dB
Expansion control threshold voltage	V _{EXPH}		2	3.0			V
Expansion control threshold voltage	V _{EXPL}		2			1.5	V
Left&Right channel output impedance	Z _{LR}		1		150	300	Ω

Audio Switch Truth Table

S4 (Pin 4)	S5 (Pin 6)	L1 (Pin 1)	L2 (Pin 3)	L3 (Pin 5)	L4 (Pin 7)	R1 (Pin 9)	R2 (Pin 11)	R3 (Pin 13)	R4 (Pin 15)
H	H	ON	OFF	OFF	OFF	ON	OFF	OFF	OFF
L	H	OFF	ON	OFF	OFF	OFF	ON	OFF	OFF
H	L	OFF	OFF	ON	OFF	OFF	OFF	ON	OFF
L	L	OFF	OFF	OFF	ON	OFF	OFF	OFF	ON

Continued from preceding page.

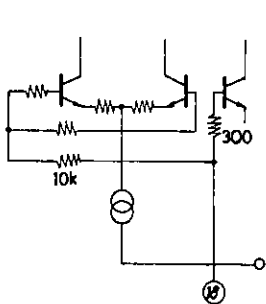

Expander Filter

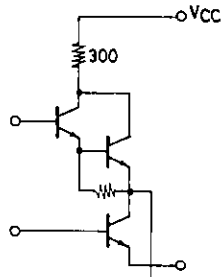

Expander Output

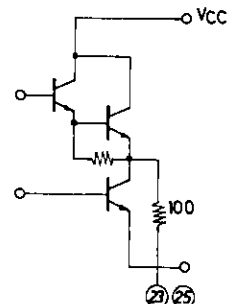

R, L Output

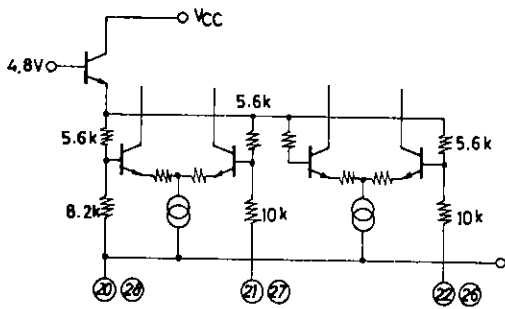

Treble, Bass Filter

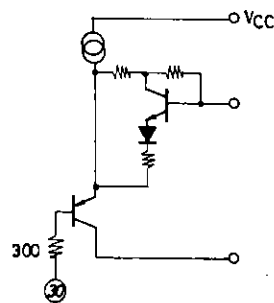

Volume Contr.

Unit (resistance : Ω)

Test Circuit (1)

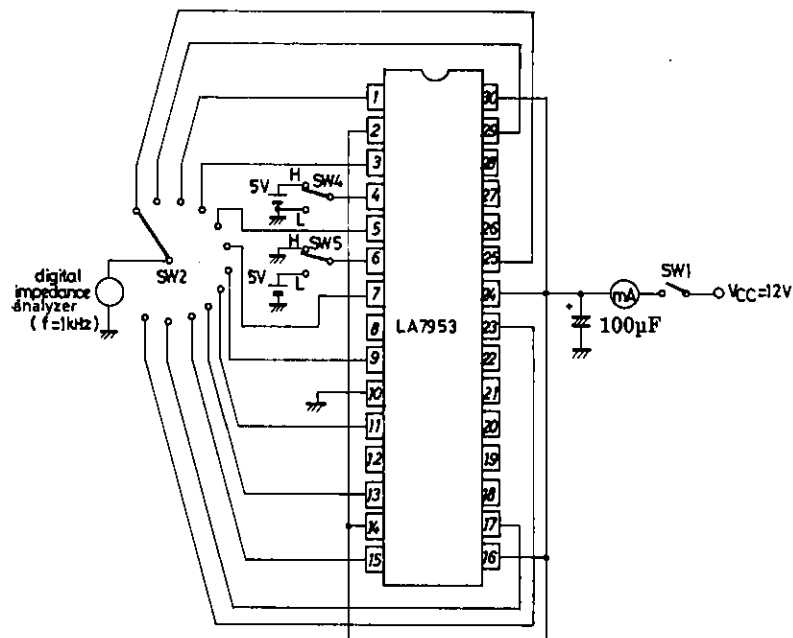

Test Circuit (2)

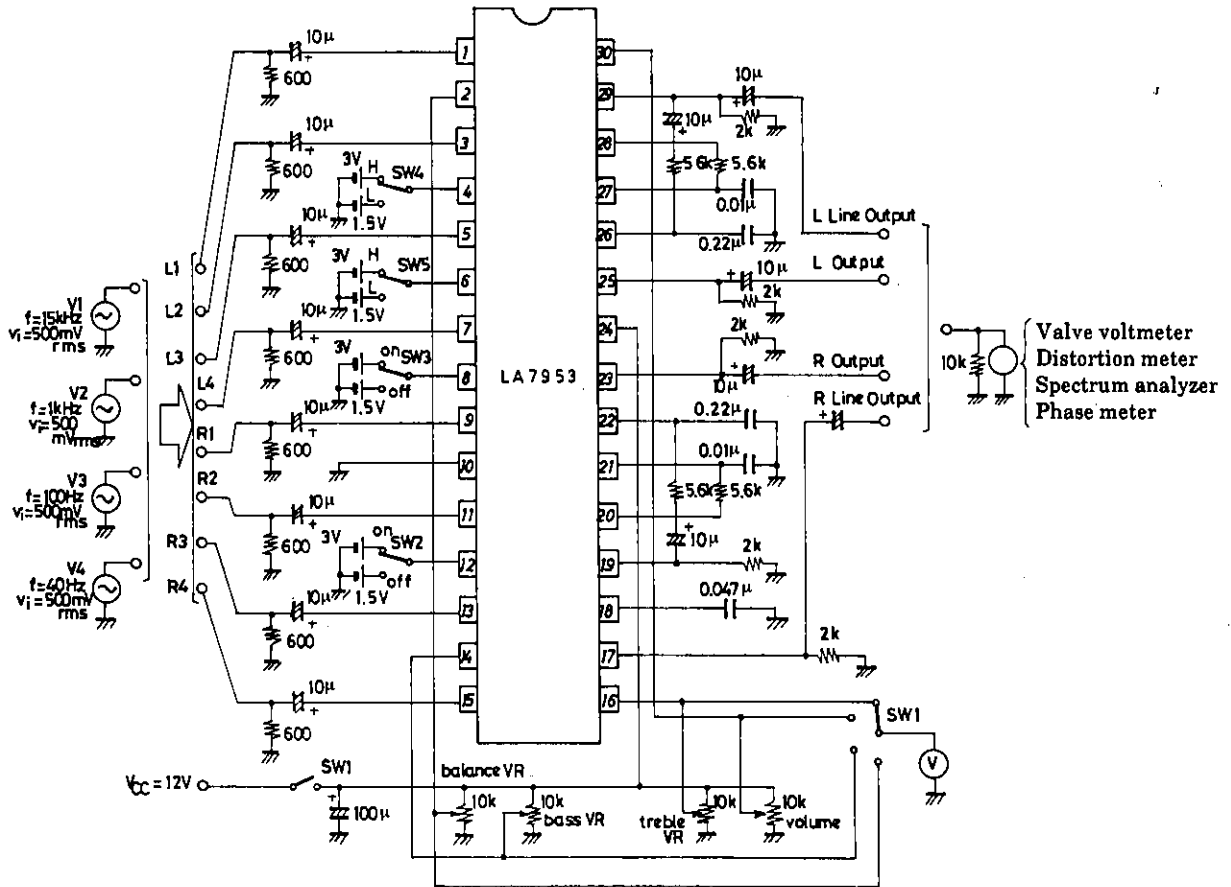

Unit (resistance : Ω, capacitance : F)

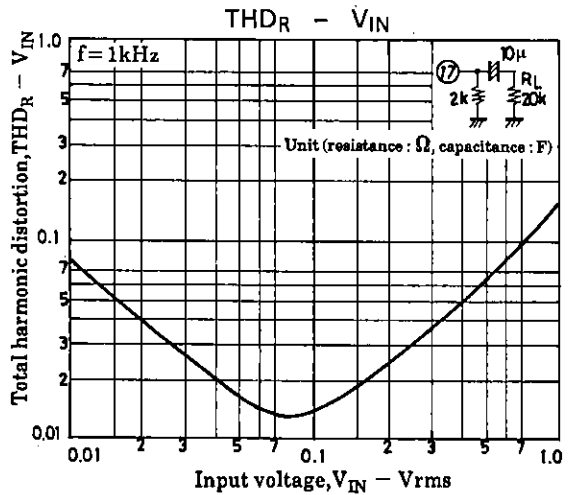
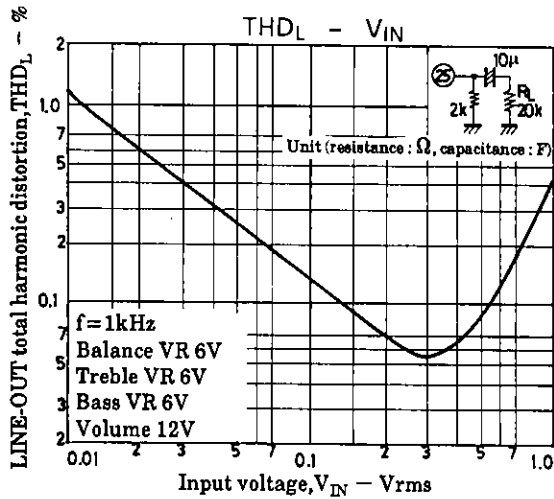

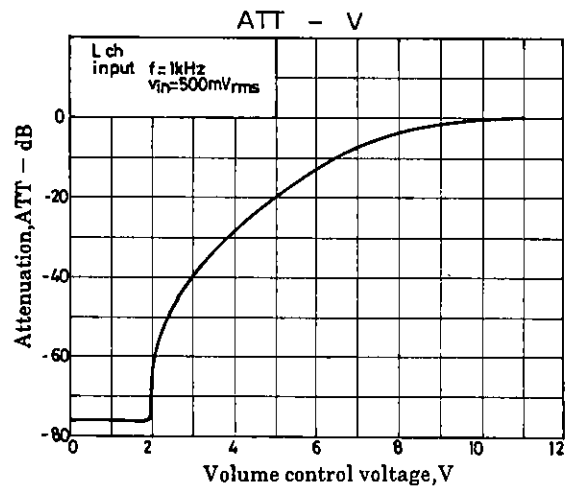
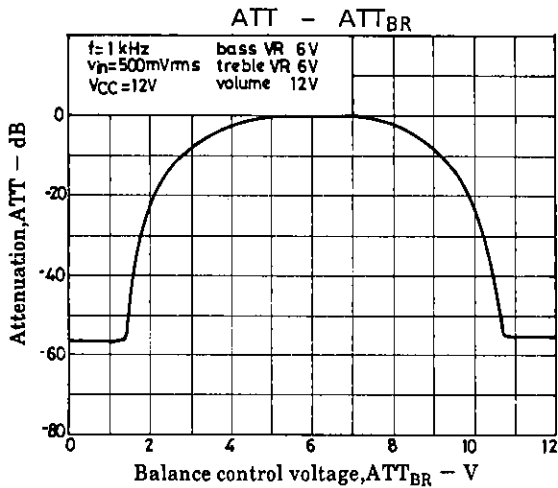
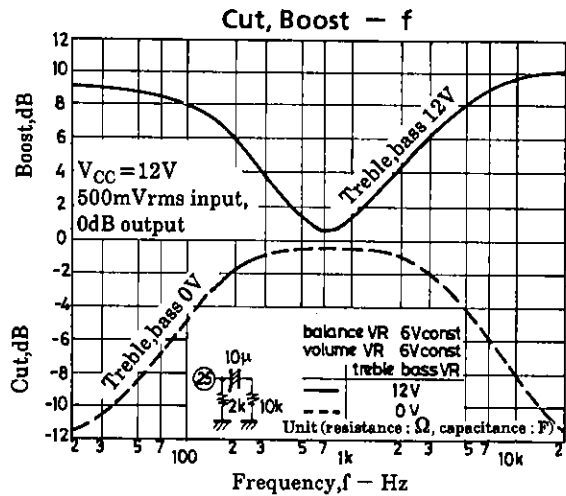
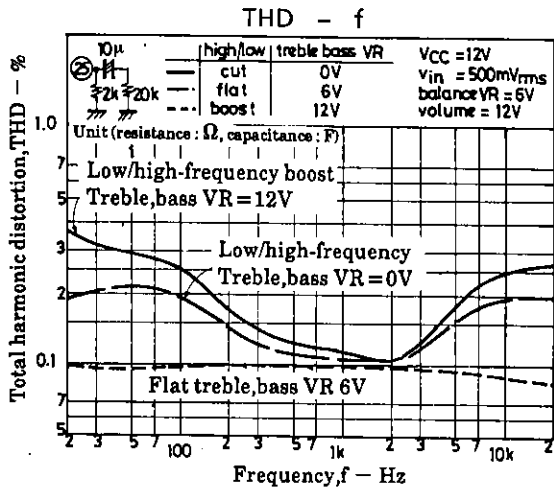

■ No products described or contained herein are intended for use in surgical implants, life-support systems, aerospace equipment, nuclear power control systems, vehicles, disaster/crime-prevention equipment and the like, the failure of which may directly or indirectly cause injury, death or property loss.

■ Anyone purchasing any products described or contained herein for an above-mentioned use shall:

- ① Accept full responsibility and indemnify and defend SANYO ELECTRIC CO., LTD., its affiliates, subsidiaries and distributors and all their officers and employees, jointly and severally, against any and all claims and litigation and all damages, cost and expenses associated with such use;
- ② Not impose any responsibility for any fault or negligence which may be cited in any such claim or litigation on SANYO ELECTRIC CO., LTD., its affiliates, subsidiaries and distributors or any of their officers and employees jointly or severally.

■ Information (including circuit diagrams and circuit parameters) herein is for example only; it is not guaranteed for volume production. SANYO believes information herein is accurate and reliable, but no guarantees are made or implied regarding its use or any infringements of intellectual property rights or other rights of third parties.

This catalog provides information as of October, 1995. Specifications and information herein are subject to change without notice.