

**LA76070****NTSC Color Television IC****Overview**

The LA76070 is an NTSC color television IC. In addition to providing IIC bus control based rationalization of IC control and the adjustment manufacturing process associated with the TV tube itself, it also includes all functions actually required in mass-produced television sets. As such, it is an extremely practical bus control IC.

* The LA7840/41 or LA7845N/46N is recommended as the vertical output IC for use with this product.

Functions

- I²C bus control, VIF, SIF, Y, C, and deflection integrated on a single chip.

Package Dimensions

unit: mm

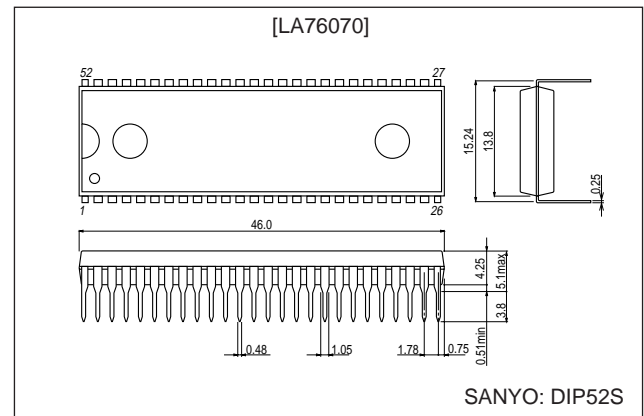
3128-DIP52S**Specifications****Maximum Ratings at Ta = 25°C**

| Parameter | Symbol | Conditions | Rating | Unit |
|------------------------------|---------|------------|-------------|------|
| Maximum power supply voltage | V4 max | | 9.6 | V |
| | V26 max | | 9.6 | V |
| Maximum power supply current | I21 max | | 25 | mA |
| Allowable power dissipation | Pd max | Ta ≤ 65°C* | 1.3 | W |
| Operating temperature | Topr | | -10 to +65 | °C |
| Storage temperature | Tstg | | -55 to +150 | °C |

Note: *Provided on a printed circuit board: 83.2 × 86.0 × 1.6 mm, material: Bakelite

Operating Conditions at Ta = 25°C

| Parameter | Symbol | Conditions | Rating | Units |
|--------------------------------------|--------|------------|------------|-------|
| Recommended power supply voltage | V4 | | 7.6 | V |
| | V26 | | 7.6 | V |
| Recommended power supply current | I21 | | 19 | mA |
| Operating power supply voltage range | V4 op | | 7.3 to 7.9 | V |
| | V26 op | | 7.3 to 7.9 | V |
| Operating power supply current range | I21 op | | 16 to 25 | mA |

■ Any and all SANYO products described or contained herein do not have specifications that can handle applications that require extremely high levels of reliability, such as life-support systems, aircraft's control systems, or other applications whose failure can be reasonably expected to result in serious physical and/or material damage. Consult with your SANYO representative nearest you before using any SANYO products described or contained herein in such applications.

■ SANYO assumes no responsibility for equipment failures that result from using products at values that exceed, even momentarily, rated values (such as maximum ratings, operating condition ranges, or other parameters) listed in products specifications of any and all SANYO products described or contained herein.

SANYO Electric Co.,Ltd. Semiconductor Company

TOKYO OFFICE Tokyo Bldg., 1-10, 1 Chome, Ueno, Taito-ku, TOKYO, 110-8534 JAPAN

LA76070

Electrical Characteristics at $T_a = 25^\circ\text{C}$, $V_{CC} = V_4 = V_{26} = 7.6\text{ V}$, $I_{CC} = I_{21} = 19\text{ mA}$

| Parameter | Symbol | Conditions | Ratings | | | Unit |
|--------------------------------------------------------|------------------------|---------------------------------------|---------|------|-------|----------|
| | | | min | typ | max | |
| [Circuit Voltages and Currents] | | | | | | |
| Horizontal power supply voltage | HV_{CC} | | 7.2 | 7.6 | 8.0 | V |
| IF power supply current (V4) | I4 ($IF_{I_{CC}}$) | IF AGC: 5 V | 38 | 46 | 54 | mA |
| Video, chroma, and vertical power supply current (V26) | I26 ($YCV_{I_{CC}}$) | | 79.5 | 93.5 | 107.5 | mA |
| [VIF Block] | | | | | | |
| AFT output voltage with no signal | $VAFT_n$ | With no input signal | 2.8 | 3.8 | 4.8 | Vdc |
| Video output voltage with no signal | VO_n | With no input signal | 4.7 | 4.9 | 5.1 | Vdc |
| APC pull-in range (U) | fPU | After APC and PLL DAC adjustment | 1.0 | | | MHz |
| APC pull-in range (L) | fPL | After APC and PLL DAC adjustment | 1.0 | | | MHz |
| Maximum RF AGC voltage | VR_{FH} | CW = 91 dB μ , DAC = 0 | 7.7 | 8.2 | 9.0 | Vdc |
| Minimum RF AGC voltage | VR_{FL} | CW = 91 dB μ , DAC = 63 | 0 | 0.2 | 0.4 | Vdc |
| RF AGC Delay Pt (@DAC = 0) | RF_{AGC0} | DAC = 0 | 96 | | | dB μ |
| RF AGC Delay Pt (@DAC = 63) | RF_{AGC63} | DAC = 63 | | | 86 | dB μ |
| Maximum AFT output voltage | $VAFT_H$ | CW = 93 dB μ , variable frequency | 6.2 | 6.5 | 7.6 | Vdc |
| Minimum AFT output voltage | $VAFT_L$ | CW = 93 dB μ , variable frequency | 0.5 | 0.9 | 1.2 | Vdc |
| AFT detection sensitivity | $VAFT_S$ | CW = 93 dB μ , variable frequency | 33 | 25 | 17 | mV/kHz |
| Video output amplitude | VO | 93 dB μ , 87.5% Video MOD | 1.8 | 2.0 | 2.2 | Vp-p |
| Synchronization signal tip level | VO_{tip} | 93 dB μ , 87.5% Video MOD | 2.4 | 2.6 | 2.8 | Vdc |
| Input sensitivity | V_i | Output at -3 dB | | 43 | 46 | dB μ |
| Video-to-sync ratio (@100 dB μ) | V/S | 100 dB μ , 87.5% Video MOD | 2.4 | 2.5 | 3.0 | |
| Differential gain | DG | 93 dB μ , 87.5% Video MOD | | 2 | 10 | % |
| Differential phase | DP | 93 dB μ , 87.5% Video MOD | | 2 | 10 | deg |
| Video signal-to-noise ratio | S/N | CW = 93 dB μ | 55 | 58 | | dB |
| 920 kHz beat level | I920 | V3.58 MHz/V920 kHz | | | -50 | dB |
| [Video and Switching Block] | | | | | | |
| External video gain | AUXG | Stair step, 1 V p-p | 5.5 | 6.0 | 6.5 | dB |
| External video sync signal tip voltage | AUXS | Stair step, 1 V p-p | -0.2 | 0.0 | +0.2 | Vdc |
| External video crosstalk | AUXC | 4.2 MHz, 1Vp-p | 60 | | | dB |
| Internal video output level | INTO | 93 dB μ , 87.5% Video MOD | -0.1 | 0.0 | +0.1 | Vp-p |
| [SIF Block] | | | | | | |
| FM detector output voltage | SOADJ | | 464 | 474 | 484 | mVrms |
| FM limiting sensitivity | SLS | Output at -3 dB | | | 50 | dB μ |
| FM detector output bandwidth | SF | Output at -3 dB | 50 | | 100 k | Hz |
| FM detector output total harmonic distortion | STHD | FM = ± 25 kHz | | | 0.5 | % |
| AM rejection ratio | SAMR | AM = 30 % | 40 | | | dB |
| SIF signal-to-noise ratio | SSN | | 60 | | | dB |
| [Audio Block] | | | | | | |
| Maximum gain | AGMAX | 1 kHz | -2.5 | 0.0 | +2.5 | dB |
| Adjustment range | ARANGE | | 60 | 67 | | dB |
| Frequency characteristics | AF | 20 kHz | -3.0 | | +3.0 | dB |
| Muting | AMUTE | 20 kHz | 75 | | | dB |
| Total harmonic distortion | ATHD | 1 kHz, 400 m Vrms, Vo1: MAX | | | 0.5 | dB |
| Signal-to-noise ratio | ASN | DIN.Audio | 65 | 75 | | dB |
| [Chroma Block] | | | | | | |
| ACC amplitude characteristics 1 | ACCM1 | Input: +6 dB/0 dB, 0 dB = 40 IRE | 0.8 | 1.0 | 1.2 | times |
| ACC amplitude characteristics 2 | ACCM2 | Input: -14 dB/0 dB | 0.7 | 1.0 | 1.1 | times |
| B-Y/Y amplitude ratio | CLRBY | | 100 | 125 | 140 | % |
| Color control characteristics 1 | CLRMN | Color MAX/NOM | 1.6 | 1.8 | 2.1 | times |
| Color control characteristics 2 | CLRMM | Color MAX/MIN | 33 | 40 | 50 | dB |

Continued on next page.

LA76070

Continued from preceding page.

| Parameter | Symbol | Conditions | Ratings | | | Unit |
|---------------------------------------------------------|----------|-----------------------------|---------|------|------|---------|
| | | | min | typ | max | |
| Color control sensitivity | CLRSE | | 1 | 2 | 4 | %/bit |
| Tint center | TINCEN | TINT NOM | -15 | | -3 | deg |
| Tint control maximum | TINMAX | TINT MAX | 30 | 45 | 60 | deg |
| Tint control minimum | TINMIN | TINT MIN | -60 | -45 | -30 | deg |
| Tint control sensitivity | TINSE | | 0.7 | | 2.0 | deg/bit |
| Demodulator output ratio R-Y/B-Y | RB | | 0.75 | 0.85 | 0.95 | |
| Demodulator output ratio G-Y/B-Y | GB | | 0.28 | 0.33 | 0.38 | |
| Demodulator angle B-Y/R-Y | ANGBR | | 92 | 99 | 107 | deg |
| Demodulator angle G-Y/B-Y | ANGGB | | 227 | 237 | 247 | deg |
| Killer operating point | KILL | 0 dB = 40 IRE | -42 | -37 | -30 | dB |
| Chrominance VCO free-running frequency | CVCOF | Deviation from 3.579545 MHz | -350 | | +350 | Hz |
| Chrominance pull-in range (+) | PULIN+ | | 350 | | | Hz |
| Chrominance pull-in range (-) | PULIN- | | | | -350 | Hz |
| Auto-flesh characteristic 73° | AF 073 | | 5 | 10 | 20 | deg |
| Auto-flesh characteristic 118° | AF 118 | | -7 | 0 | +7 | deg |
| Auto-flesh characteristic 163° | AF 163 | | -20 | -10 | -5 | deg |
| [Video Block] | | | | | | |
| Overall video gain (Contrast set to maximum) | CONT63 | | 10 | 12 | 14 | dB |
| Contrast adjustment characteristic (Normal/maximum) | CONT32 | | -7.5 | -6.0 | -4.5 | dB |
| Contrast adjustment characteristic (Minimum/maximum) | CONT0 | | -17 | -14 | -11 | dB |
| Video frequency characteristic Trap & D = 0 | Yf0 | | -6.0 | -3.5 | 0.0 | dB |
| Chrominance trap level Trap & D = 1 | Ctrap | | | -20 | | dB |
| DC propagation | ClampG | | 95 | 100 | 105 | % |
| Y delay, f0 = 1 | YDLY | | | 430 | | ns |
| Maximum black stretching gain | BKSTmax | | 6 | 13 | 20 | IRE |
| Sharpness adjustment range | (normal) | Sharp16 | 4 | 6 | 8 | dB |
| | (max) | Sharp31 | 9.0 | 11.5 | 14.0 | dB |
| | (min) | Sharp0 | -6.0 | -3.5 | -1.0 | dB |
| Horizontal/vertical blanking output level | RGBBLK | | 1.4 | 1.6 | 1.8 | V |
| [OSD Block] | | | | | | |
| OSD fast switch threshold | FSTH | | 0.9 | 1.2 | 1.7 | V |
| Red RGB output level | ROSDH | | 220 | 250 | 280 | IRE |
| Green RGB output level | GOSDH | | 220 | 250 | 280 | IRE |
| Blue RGB output level | BOSDH | | 220 | 250 | 280 | IRE |
| Analog OSD R output level gain matching | RRGB | | 1.5 | 1.9 | 2.3 | Ratio |
| Linearity | LRRGB | | 45 | 50 | 60 | % |
| Analog OSD G output level gain matching | GRGB | | 1.5 | 1.9 | 2.3 | Ratio |
| Linearity | LGRGB | | 45 | 50 | 60 | % |
| Analog OSD B output level gain matching | BRGB | | 1.5 | 1.9 | 2.3 | Ratio |
| Linearity | LBRGB | | 45 | 50 | 60 | % |
| [RGB Output (cutoff and drive) Block] | | | | | | |
| Brightness control (normal) | BRT64 | | 2.1 | 2.65 | 3.2 | V |
| High brightness (maximum) | BRT127 | | 15 | 20 | 25 | IRE |
| Low brightness (minimum) | BRT0 | | -25 | -20 | -15 | IRE |

Continued on next page.

LA76070

Continued from preceding page.

| Parameter | | Symbol | Conditions | Ratings | | | Unit |
|----------------------------------------------------|--------------------|---------------|------------|-----------|---------|-------|---------|
| | | | | min | typ | max | |
| Cutoff control (Bias control) | (minimum) | Vbias0 | | 2.1 | 2.65 | 3.2 | V |
| | (maximum) | Vbias127 | | 2.45 | 3.0 | 3.55 | V |
| | Resolution | Vbiasns | | | 4 | | mV/Bit |
| Drive adjustment | Maximum output | RBout127 | | | 2.9 | | Vp-p |
| | | Gout127 | | | 2.4 | | Vp-p |
| | Output attenuation | RBout0 | | 7 | 9 | 11 | dB |
| [Deflection Block] | | | | | | | |
| Sync separator sensitivity | Ssync | | | 3 | 8 | 13 | IRE |
| Horizontal free-running frequency deviation | Δf_H | | | 15600 | 15734 | 15850 | Hz |
| Horizontal pull-in range | fH PULL | | | ± 400 | | | Hz |
| Horizontal output pulse saturation voltage | V Hsat | | | 0 | 0.06 | 0.4 | V |
| Horizontal output pulse phase | HPHCEN | | | 9.5 | 10.5 | 11.5 | μ s |
| Horizontal position adjustment range | HPHrange | 4 bits | | | ± 2 | | μ s |
| Horizontal position adjustment maximum variability | HPHstep | | | | | 530 | ns |
| X-ray protection circuit operating voltage | VXRAY | | | 0.54 | 0.64 | 0.74 | V |
| [Vertical screen Size Adjustment] | | | | | | | |
| Vertical ramp output amplitude @32 | Vsize32 | VSIZE: 100000 | | 0.47 | 0.82 | 1.17 | Vp-p |
| Vertical ramp output amplitude @0 | Vsize0 | VSIZE: 000000 | | 0.13 | 0.48 | 0.83 | Vp-p |
| Vertical ramp output amplitude @63 | Vsize63 | VSIZE: 111111 | | 0.80 | 1.15 | 1.50 | Vp-p |
| [Vertical screen Position Adjustment] | | | | | | | |
| Vertical ramp DC voltage @32 | Vdc32 | VDC: 100000 | | 3.6 | 3.8 | 4.0 | Vdc |
| Vertical ramp DC voltage @0 | Vdc0 | VDC: 000000 | | 3.2 | 3.4 | 3.6 | Vdc |
| Vertical ramp DC voltage @63 | Vdc63 | VDC: 111111 | | 4.0 | 4.2 | 4.4 | Vdc |

LA76070

LA76070 BUS: Initial Conditions

| Initial test conditions | |
|-------------------------|--------|
| Register | |
| T Enable | 0 HEX |
| Video Mute | 1 HEX |
| Sync Kill | 0 HEX |
| AFC Gain | 0 HEX |
| Horizontal Phase | 4 HEX |
| IF AGC SW | 0 HEX |
| AFT Defeat | 0 HEX |
| RF AGC Delay | 20 HEX |

| Initial test conditions (continued) | |
|-------------------------------------|--------|
| Register | |
| Video SW | 0 HEX |
| PLL Tuning | 40 HEX |
| Audio Mute | 1 HEX |
| APC Det Adjust | 20 HEX |
| V CD Mode | 0 HEX |
| Vertical DC | 20 HEX |
| Vertical Kill | 0 HEX |
| Col Kill | 0 HEX |
| Vertical Size | 20 HEX |
| Red Bias | 00 HEX |
| Green Bias | 00 HEX |
| Blue Bias | 00 HEX |
| Blanking Defeat | 0 HEX |
| Red Drive | 7F HEX |
| Blue Drive | 7F HEX |
| Color Difference Mode Enable | 0 HEX |
| Brightness Control | 40 HEX |
| Contrast Test Enable | 0 HEX |
| Contrast Control | 40 HEX |
| Trap & Delay Enable SW | 0 HEX |
| Auto Flesh | 0 HEX |
| Black Stretch Defeat | 0 HEX |
| Sharpness Control | 10 HEX |
| Tint Test Enable | 0 HEX |
| Tint Control | 40 HEX |
| Color Test Enable | 0 HEX |
| Color Control | 40 HEX |
| Vertical Test | 0 HEX |
| Video Level | 4 HEX |
| FM Level | 10 HEX |
| BNI Enable | 0 HEX |
| Audio SW | 0 HEX |
| Volume Control | 00 HEX |

LA76070

LA76070 BUS: Control Register Descriptions

| Control register descriptions | | |
|-------------------------------|------|--------------------------------------------|
| Register name | Bits | General descriptions |
| T Enable | 1 | Disable the Test SW & enable Video Mute SW |
| Video Mute | 1 | Disable video outputs |
| Sync Kill | 1 | Force free-run mode |
| AFC Gain | 1 | Select horizontal first loop gain |
| Horizontal Phase | 3 | Align sync to flyback phase |
| IF AGC SW | 1 | Disable IF and RF AGC |
| AFT Defeat | 1 | Disable AFT output |
| RF AGC Delay | 6 | Align RF AGC threshold |
| Video SW | 1 | Select Video Signal (INT/EXT) |
| PLL Tuning | 7 | Align IF VCO frequency |
| Audio Mute | 1 | Disable audio outputs |
| APC Det Adjust | 6 | Align AFT crossover |
| V Count Down Mode | 1 | Select vertical countdown mode |
| Vertical DC | 6 | Align vertical DC bias |
| Vertical Kill | 1 | Disable vertical output |
| Color Kill | 1 | Enable Color Killer |
| Vertical Size | 6 | Align vertical amplitude |
| Red Bias | 7 | Align Red OUT DC level |
| Green Bias | 7 | Align Green OUT DC level |
| Blue Bias | 7 | Align Blue OUT DC level |
| Blanking Defeat | 1 | Disable RGB output blanking |
| Red Drive | 6 | Align Red OUT AC level |
| Drive Test | 1 | Enable drive DAC test mode |
| Blue Drive | 6 | Align Blue OUT AC level |
| Color Difference Mode Enable | 1 | Enable color difference mode |
| Brightness Control | 7 | Customer brightness control |
| Contrast Test | 1 | Enable Contrast DAC test mode |
| Contrast Control | 7 | Customer Contrast control |
| Trap & Delay-SW | 1 | Select luma filter mode |
| Auto Flesh Enable | 1 | Enable autoflesh function |
| Black Stretch Defeat | 1 | Disable black stretch |
| Sharpness Control | 5 | Customer sharpness control |
| Tint Test | 1 | Enable tint DAC test mode |
| Tint Control | 7 | Customer tint control |
| Color Test | 1 | Enable color DAC test mode |
| Color Control | 7 | Customer color control |
| Vertical Test | 3 | Select vertical DAC test modes |
| Video Level | 3 | Align IF video level |
| FM Level | 5 | Align WBA output level |
| BNI Enable | 1 | Enable black noise inverter |
| Audio SW | 1 | Select Audio Signal (INT/EXT) |
| Volume Control | 6 | Customer volume control |

LA76070

LA76070 BUS: Control Register Truth Table

| Control register truth table | | |
|------------------------------|-------------|---------------|
| Register name | 0 HEX | 1 HEX |
| T Enable | Test Enable | Test Disable |
| Audio Mute | Active | Mute |
| Video Mute | Active | Mute |
| Sync Kill | Sync active | Sync Killed |
| AFC Gain | Slow | Fast |
| IF AGC SW | AGC active | AGC Defeat |
| AFT Defeat | AFT active | AFT Defeat |
| BNI Enable | BNI active | BNI Defeat |
| Count Down Mode | Standard | Non-Stand |
| Vertical Kill | Vrt active | Vrt Killed |
| F0 Select | 3.58 trap | 8.00 APF |
| Auto Flesh Enable | AF Off | AF On |
| Overload Enable | Ovld Off | Ovld On |
| Tint DAC Test | Normal | Test Mode |
| Color DAC Test | Normal | Test Mode |
| Contrast DAC Test | Normal | Test Mode |
| Drive DAC Test | Normal | Test Mode |
| Black Stretch Defeat | Blk Str On | Blk Str Off |
| Blanking Defeat | Blanking | No Blank |
| Color Diff Mode Enable | RGB Mode | C Diff Mode |
| Vertical Test | Normal | Ver Size Test |

LA76070

LA76070 Bit Map ('96.08.01)

IC address: BAH (101111010)

| Sub address D0....D7 | MSB | DATA | | | | | | LSB |
|-------------------------|----------------------|-----------------------------|-------------------------------|------------------------|---------------|------------------|---------------|----------------|
| | DA0 | DA1 | DA2 | DA3 | DA4 | DA5 | DA6 | DA7 |
| \$00 (tr0) | * | * | * | * | T_Enable 0 | * | Vid_Mute 1 | Sync_Kill 0 |
| \$01 (tr1) | * | * | * | * | AFC Gain 0 | H_Phase 1 0 0 | | |
| \$02 (tr2) | IFAGC SW 0 | AFT DEF 0 | RF_AGC_Delay 1 0 0 0 0 0 | | | | | |
| \$03 (tr3) | VIDEO SW 0 | PLL TUNING 1 0 0 0 0 0 0 | | | | | | |
| \$04 (tr4) | * | Aud_Mute 1 | APC DET ADJUST 1 0 0 0 0 0 | | | | | |
| \$05 (tr5) | V CD MODE 0 | * | Ver_dc 1 0 0 0 0 0 | | | | | |
| \$06 (tr6) | Ver_kill 0 | Col_kill 0 | Ver_Size 1 0 0 0 0 0 | | | | | |
| \$07 (tr7) | * | R_Bias 0 0 0 0 0 0 0 | | | | | | |
| \$08 (tr8) | * | G_Bias 0 0 0 0 0 0 0 | | | | | | |
| \$09 (tr9) | * | B_Bias 0 0 0 0 0 0 0 | | | | | | |
| \$0A (tr10) | BLK_DEF 0 | R_Drive 1 1 1 1 1 1 1 | | | | | | |
| \$0B (tr11) | Drv_Test 0 | B_Drive 1 1 1 1 1 1 1 | | | | | | |
| \$0C (tr12) | C_Diff 0 | Bright 1 0 0 0 0 0 0 | | | | | | |
| \$0D (tr13) | Cot_Test 0 | Contrast 1 0 0 0 0 0 0 | | | | | | |
| \$0E (tr14) | Trap & D_SW 0 | A Fresh 0 | Black ST 0 | Sharpness 1 0 0 0 0 | | | | |
| \$0F (tr15) | Tint_Test 0 | Tint 1 0 0 0 0 0 0 | | | | | | |
| \$10 (tr16) | Col_Test 0 | Color 1 0 0 0 0 0 0 | | | | | | |
| \$11 (tr17) | * | * | * | * | * | V_test 0 0 0 | | |
| \$12 (tr18) | VIDEO LEVEL 1 0 0 | | | FM LEVEL 1 0 0 0 0 | | | | |
| \$13 (tr19) | N/I SW 0 | AUDIO SW 0 | VOLUME 0 0 0 0 0 0 | | | | | |





LA76070

Measurement Conditions at $T_a = 25^\circ\text{C}$, $V_{CC} = V_4 = V_{26} = 7.6\text{ V}$, $I_{CC} = I_{21} = 19\text{ mA}$

| Parameter | Symbol | Measurement point | Input signal | Measurement method | Bus conditions |
|----------------------------------------------|----------------------------|-------------------|--------------|-------------------------------------------------------------------------------------------------------------------------|--------------------|
| [Circuit Voltages and Currents] | | | | | |
| Horizontal power supply voltage | HV_{CC} | 21 | | Apply a 19mA current to pin 21 and measure the pin 21 voltage at that time | Initial conditions |
| IF power supply current (pin 4) | I_4 (IF_{CC}) | 4 | No signal | Apply a voltage of 7.6 V to pin 4 and measure (in mA) the DC current that flows into the IC. (Apply 5 V to the IF AGC.) | Initial conditions |
| Video/vertical power supply current (pin 26) | I_{26} (DEF_{CC}) | 26 | | Apply a voltage of 7.6 V to pin 26 and measure (in mA) the DC current that flows into the IC | Initial conditions |

VIF Block Input Signals and Measurement Conditions

1. All input signals are applied to PIF IN (pin 10) as shown in the measurement circuit diagrams.
2. The input signal voltage values are all the value of VIF IN (pin 10) as shown in the measurement circuit diagrams.
3. The table below lists the input signals and their levels.

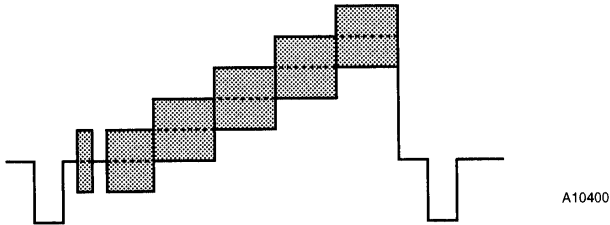
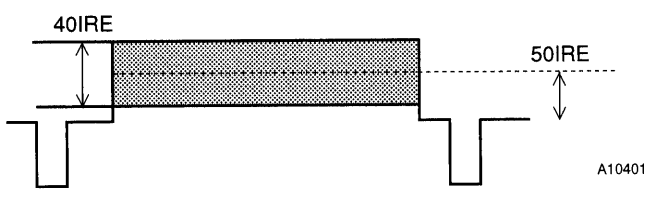
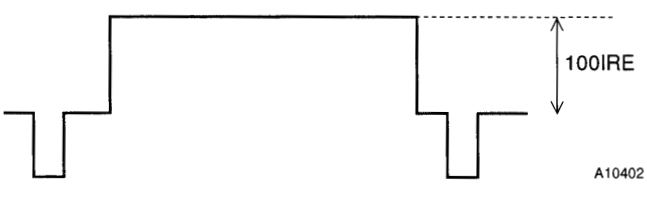
| Input signal | Waveform | Condition |
|--------------|----------------------------------------------------------------------------------------------|-----------------------------------------------------------------------------------------------------|
| SG1 |  CW A10396 | 45.75 MHz |
| SG2 |  CW A10397 | 42.17 MHz |
| SG3 |  CW A10398 | 41.25 MHz |
| SG4 |  CW A10399 | Variable frequency |
| SG5 |  A10400 | 45.75 MHz 87.5 % video modulation 10-step staircase waveform (Subcarrier: 3.58 MHz) |
| SG6 |  A10401 | 45.75 MHz 87.5 % video modulation Sweep signal (APL: 50 IRE Sweep signal level: 40 IRE) |
| SG7 |  A10402 | 45.75 MHz 87.5 % video modulation Flat field signal |

4. Perform the following D/A converter adjustments in the order listed before testing.

| Item | Measurement point | Input signal | Adjustment |
|----------------|-------------------|---------------------------|-------------------------------------------------------------------------------------------|
| APC DAC | (13) | No signal, IF.AGC.DEF = 1 | Set up the DAC value so that the pin 13 DC voltage is as close to 3.8 V as possible |
| PLL DAC | (13) | SG1, 93 dB μ | Set up the DAC value so that the pin 13 DC voltage is as close to 3.8 V as possible |
| Video possible | (45) | SG7, 93 dB μ | Set up the DAC value so that the pin 45 output level is as close to 2.0 V p-p as possible |



LA76070

| Parameter | Symbol | Measurement point | Input signal | Measurement procedure | Bus conditions |
|---------------------------------------|------------------|-------------------|----------------------|--------------------------------------------------------------------------------------------------------------------------------------------------------------------------------------------------------------------------------------------------------------------------------------------------------------------------------------------------------------------------------------------------------------------------------------------------------------------------|---------------------------------------------------------|
| [VIF Block] | | | | | |
| AFT output voltage with no signal | VAFTn | 13 | No signal | Measure the pin 13 DC voltage when IF.AGC. DEF is "1" | After performing the adjustments described in section 4 |
| Video output voltage with no signal | VOn | 45 | No signal | Measure the pin 45 DC voltage when IF.AGC. DEF is "1" | After performing the adjustments described in section 4 |
| APC pull-in range (U), (L) | fPU, fPL | 45 | SG4 93 dB μ | Connect an oscilloscope to pin 45 and modify the SG4 signal to be a frequency above 45.75 MHz so that the PLL circuit becomes unlocked. (Beating will occur in this state.) Gradually lower the SG4 frequency and measure the frequency at which the PLL circuit locks. Similarly, modify the frequency to a value below 45.75 MHz so that the PLL circuit becomes unlocked. Gradually raise the SG4 frequency and measure the frequency at which the PLL circuit locks. | After performing the adjustments described in section 4 |
| Maximum RF AGC voltage | V _{RFH} | 6 | SG1 91 dB μ | Set the RF AGC DAC to 0 and measure the pin 6 DC voltage | After performing the adjustments described in section 4 |
| Minimum RF AGC voltage | V _{RFL} | 6 | SG1 91 dB μ | Set the RF AGC DAC to 63 and measure the pin 6 DC voltage | After performing the adjustments described in section 4 |
| RF AGC Delay Pt (@DAC = 0) | RFAGC0 | 6 | SG1 | Set the RF AGC DAC to 0 and determine the input level such that the pin 6 DC voltage becomes 3.8 V \pm 0.5 V | After performing the adjustments described in section 4 |
| RF AGC Delay Pt (@DAC = 63) | RFAGC63 | 6 | SG1 | Set the RF AGC DAC to 63 and determine the input level such that the pin 4 DC voltage becomes 3.8 V \pm 0.5 V | After performing the adjustments described in section 4 |
| Maximum AFT output voltage | VAFTH | 13 | SG4 93 dB μ | Set the SG4 signal frequency to 44.75 MHz and input that signal. Measure the pin 13 DC voltage at that time. | After performing the adjustments described in section 4 |
| Minimum AFT output voltage | VAFTL | 13 | SG4 93 dB μ z | Set the SG4 signal frequency to 46.75 MHz and input that signal. Measure the pin 13 DC voltage at that time. | After performing the adjustments described in section 4 |
| AFT detection sensitivity | VAFTS | 13 | SG4 93 dB μ z | Modify the SG4 frequency to determine the frequency deviation (Δf) such that the pin 13 DC voltage changes from 2.5 V to 5.0 V. VAFTS = 2500/ Δf [mV/kHz] | After performing the adjustments described in section 4 |
| Video output amplitude | VO | 45 | SG7 93 dB μ | Observe pin 45 with an oscilloscope and measure the p-p value of the waveform | After performing the adjustments described in section 4 |
| Synchronization signal tip level | VOtip | 45 | SG1 93 dB μ | Measure the pin 45 DC voltage | After performing the adjustments described in section 4 |
| Input sensitivity | Vi | 45 | SG7 | Observe pin 45 with an oscilloscope and measure the peak-to-peak value of the waveform. Next, gradually lower the input level to determine the input level such that the output becomes -3 dB below the video signal amplitude VO. | After performing the adjustments described in section 4 |
| Video-to-sync ratio (@ 100 dB μ) | V/S | 45 | SG7 100 dB μ | Observe pin 45 with an oscilloscope and determine the value of the Vy/Vs ratio by measuring the peak-to-peak value of the sync waveform (Vs) and the peak-to-peak value of the luminance signal (Vy). | After performing the adjustments described in section 4 |
| Differential gain | DG | 45 | SG5 93 dB μ | Measure pin 45 with a vectorscope | After performing the adjustments described in section 4 |
| Differential phase | DP | 45 | SG5 93 dB μ | Measure pin 45 with a vectorscope | After performing the adjustments described in section 4 |
| Video signal-to-noise ratio | S/N | 45 | SG1 93 dB μ | Pass the noise voltage that occurs on pin 45 through a 10 kHz to 4 MHz bandpass filter, measure that voltage (Vsn) with an rms voltmeter. Use that value to calculate 20 \times log (1.43/Vsn). | After performing the adjustments described in section 4 |
| 920 kHz beat level | 1920 | 45 | SG1 SG2 SG3 | Input SG1 at 93 dB μ and measure the pin 12 DC voltage (V12). Mix three signals: SG1 at 87 dB μ , SG2 at 82 dB μ , and SG3 at 63 dB μ , and input that signal to VIF IN. Now, apply the V12 voltage to pin 12 using an external power supply. Measure the difference between the 3.58 MHz component and the 920 kHz component with a spectrum analyzer. | After performing the adjustments described in section 4 |

LA76070

Video Switch Block - Input Signals and Measurement Conditions

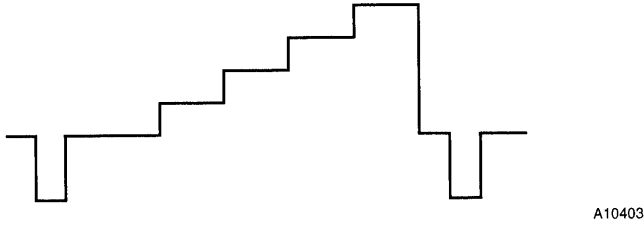
1. Unless otherwise indicated, these measurements are to be performed with no signal applied to PIF IN (pin 10) and with the D/A converter IF.ACG.SW set to "1".
2. The table below lists the input signals and their labels.

| Input signal | Waveform | Condition |
|--------------|------------------------------------------------------------------------------------|---------------------------------------|
| SG8 |  | 10-step staircase waveform 1 V p-p |
| SG9 |  | 4.2 MHz 1 Vp-p |

| Parameter | Symbol | Measurement point | Input signal | Measurement procedure | Bus conditions |
|----------------------------------------|--------|-------------------|----------------------------------------|---------------------------------------------------------------------------------------------------------------------------------------------------------------------------------------------------------------------------------------------|-------------------------------------------------------------------------------------------------|
| [VIF Block] | | | | | |
| External video gain | AUXG | 42 | Pin 1 SG8 | Observe pin 42 with an oscilloscope, measure the peak-to-peak value of the waveform, and perform the following calculation. $AUXG = 20 \times \log (Vp-p) [dB]$ | VIDEO.SW = "1" |
| External video sync signal tip voltage | AUXS | 42 | Pin 1 SG8 | Observe pin 42 with an oscilloscope and measure the synchronizing signal tip voltage in the waveform. Determine the voltage difference between this measured value and synchronizing signal tip level (VOTip) measured in the VIF block. | VIDEO.SW = "1" |
| External video crosstalk | AUXC | 42 | Pin 1 SG8 | Measure the 4.2 MHz component in the pin 42 signal with a spectrum analyzer. Convert this measurement to a V peak-to-peak value and perform the following calculation. $AUXC = 20 \times \log (1.4/Vp-p) [dB]$ | VIDEO.SW = "0" |
| Internal video output level | INTO | 42 | Pin 10 SG7 (VIF block) 93 dBμ | Observe pin 45 with an oscilloscope and measure the peak-to-peak value of the waveform. Determine the difference between this measured value and the video output amplitude (VO) measured in the VIF block. | After performing the adjustments described in section 4 IF. AGC. SW = "0" VIDEO. SW = "0" |

LA76070

SIF Block (FM Block) - Input Signals and Measurement Conditions

Unless otherwise indicated, set up the following conditions for each of the following measurements.

1. Bus control condition: IF.AGC.DEF = 1
2. SW: IF1 = off
3. Apply the input signal to pin 49 and use a 4.5 MHz carrier signal.

| Parameter | Symbol | Measurement point | Input signal | Measurement procedure | Bus conditions |
|----------------------------------------------|--------|-------------------|---------------------------------------------------|-----------------------------------------------------------------------------------------------------------------------------------------------------------------------------------------------------|---------------------------|
| FM detector output voltage | SOADJ | 7 | 90 dB μ , fm = 1 kHz, FM = \pm 25 kHz | Adjust the DAC (FM.LEVEL) so that the pin 7 FM detector output 1kHz component is as close to 474 mV rms as possible, and measure the output at that time in mV rms. Record this measurement as SV1. | |
| FM limiting sensitivity | SLS | 7 | fm = 1 kHz, FM = \pm 25 kHz | Determine the input level (in dB μ) such that the pin 7 FM detector output 1kHz component is -3 dB down from the SV1 value | FM.LEVEL = adjusted value |
| FM detector output bandwidth | SF | 7 | 90 dB μ , FM = \pm 25 kHz | Determine the modulation frequency bandwidth (Hz) that is -3 dB or higher relative to the pin 7 FM detector output SV1 value | FM.LEVEL = adjusted value |
| FM detector output total harmonic distortion | STHD | 7 | 90 dB μ , fm = 1 kHz, FM = \pm 25 kHz | Determine the total harmonic distortion in the pin 7 FM detector output 1kHz component | FM.LEVEL = adjusted value |
| AM rejection ratio | SAMR | 7 | 90 dB μ , fm = 1 kHz, AM = 30% | Measure the pin 7 FM detector output 1kHz component (in mV rms). Record this measured value as SV2 and perform the following calculation. SAMR = $20 \times \log (SV1/SV2)$ [dB] | FM.LEVEL = adjusted value |
| SIF signal-to-noise ratio | SSN | 7 | 90 dB μ , CW | Set SW1:IF1 to the "ON" Measure the pin 7 noise level (in mV rms). Record this measured value as SV3 and perform the following calculation. SSN = $20 \times \log (SV1/SV3)$ [dB] | FM.LEVEL = adjusted value |

Audio Block - Input Signals and Test Conditions

| Parameter | Symbol | Measurement point | Input signal | Measurement procedure | Bus conditions |
|---------------------------|--------|-------------------|-------------------------|--------------------------------------------------------------------------------------------------------------------------------------------------|---------------------------------------|
| Maximum gain | AGMAX | 51 | 1 kHz, CW 400m Vrms | Measure the output pin 1kHz component (V1: mV rms) and perform the following calculation. AGMAX = $20 \times \log (V1/400)$ [dB] | VOLUME = "111111" AUDIO.MUTE = "0" |
| Variability range | ARANGE | 51 | 1 kHz, CW 400m Vrms | Measure the output pin 1kHz component (V2: mV rms) and perform the following calculation. AGMAX = $20 \times \log (V1/V2)$ [dB] | VOLUME = "000001" AUDIO.MUTE = "0" |
| Frequency characteristics | AF | 51 | 20 kHz, CW 400m Vrms | Measure the output pin 20kHz component (V3: mV rms) and perform the following calculation. AF = $20 \times \log (V3/V1)$ [dB] | VOLUME = "111111" AUDIO.MUTE = "0" |
| Muting | AMUTE | 51 | 20 kHz, CW 400m Vrms | Measure the output pin 20kHz component (V4: mV rms) and perform the following calculation. AMUTE = $20 \times \log (V3/V4)$ [dB] | VOLUME = "000000" AUDIO.MUTE = "0" |
| Total harmonic distortion | ATHD | 51 | 1 kHz, CW 400m Vrms | Determine the total harmonic distortion in output pin 1kHz component | VOLUME = "111111" AUDIO.MUTE = "0" |
| Signal-to-noise ratio | ASN | 51 | No signal | Measure the noise level (DIN.AUDIO) on the output pin (V5: mV rms) and perform the following calculation. ASN = $20 \times \log (V1/V5)$ [dB] | VOLUME = "111111" AUDIO.MUTE = "0" |

Chrominance Block - Input Signals and Measurement Conditions

Unless otherwise indicated, set up the following conditions for each of the following measurements.

1. VIF and SIF blocks: No signal
2. Deflection block: Input a horizontal and vertical composite synchronizing signal, and assure that the deflection block is locked to the synchronizing signal. (Refer to the "Deflection Block - Input Signals and Measurement Conditions" section.)
3. Bus control conditions: All conditions set to the initial conditions unless otherwise specified.
4. Y input: No signal
5. C input: The C1IN input (pin 40) must be used.
6. The following describes the method for calculating the demodulation angle.

$$\text{B-Y axis angle} = \tan^{-1} (B(0)/B(270) + 270^\circ)$$

$$\text{R-Y axis angle} = \tan^{-1} (R(180)/R(90) + 90^\circ)$$

$$\text{G-Y axis angle} = \tan^{-1} (G(270)/G(180) + 180^\circ)$$

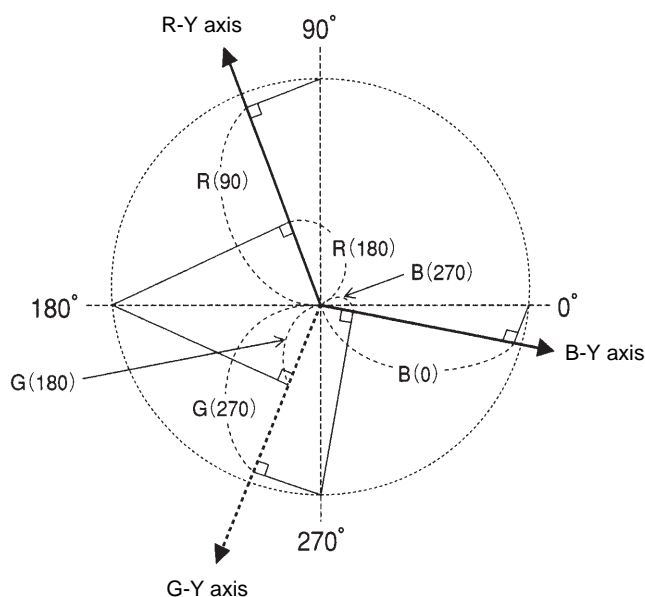

A10405

7. The following describes the method for calculating the AF angle.
BR ... The ratio between the B-Y and R-Y demodulator outputs.
 θ ANGBR: The B-Y/R-Y demodulation angle

$$\text{AFXXX} = \tan^{-1} \left[\frac{\text{R-Y/B-Y} \times \text{BR} - \text{Cos} \theta}{\text{Sin} \theta} \right]$$

8. Attach a TV crystal externally to pin 15.

Chrominance Input Signals

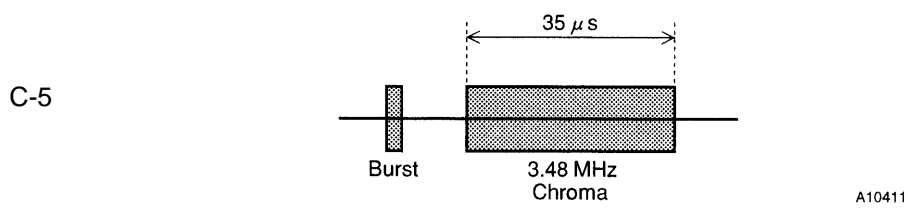
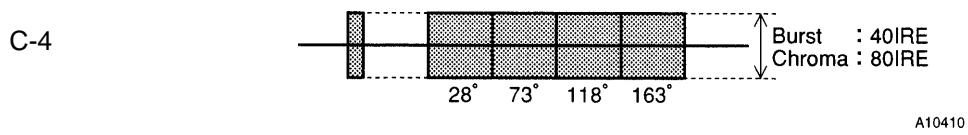
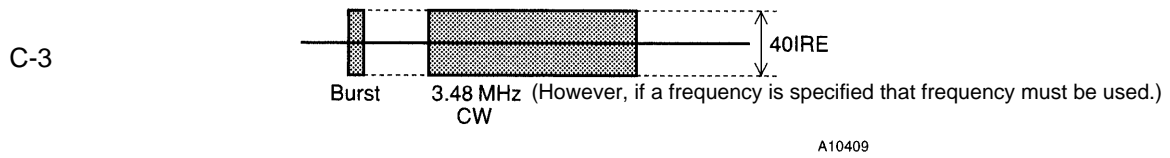
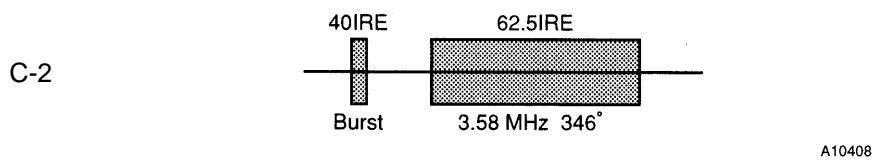
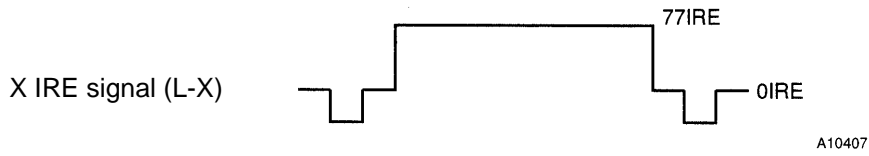
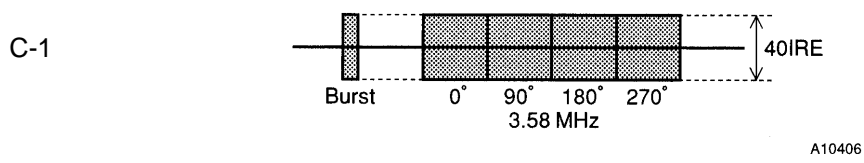

LA76070

| Parameter | Symbol | Measurement point | Input signal | Measurement procedure | Bus and other conditions |
|--------------------------------------|--------|-------------------|-------------------------------|------------------------------------------------------------------------------------------------------------------------------------------------------------------------------------------------------------------------|-----------------------------------------------------------|
| [Chroma Block] | | | | | |
| ACC amplitude characteristic 1 | ACCM1 | Bout 30 | C-1 0 dB +6 dB | Measure the output amplitudes when the chrominance signal input is 0 dB and when that input is +6 dB and calculate the ratio. $ACCM1 = 20 \times \log (+6 \text{ dBdata}/0\text{dBdata})$ | |
| ACC amplitude characteristic 2 | ACCM2 | Bout 30 | C-1 -14 dB | Measure the output amplitude when the chrominance signal input is -14 dB and calculate the ratio. $ACCM2 = 20 \times \log (-14 \text{ dBdata}/0\text{dBdata})$ | |
| B-Y/Y amplitude ratio | CLRBY | 30 | YIN: L77 C-1: No signal | Measure the Y output level (Record this measurement as V1) | |
| | | | C-2 | Next, input a signal to CIN, and (with YIN a sync-only signal) measure the output level. (Record this measurement as V2) Calculate CLRBY from the following formula. $CLRBY = 100 \times (V2/V1) + 15\%$ | |
| Color control characteristic 1 | CLRMN | 30 | C-3 | Measure V1: the output amplitude when the color control is maximum, and V2: the output amplitude when the color control is nominal. Calculate CLRMN as $V1/V2$. | TR24: Saturation 01111111 Saturation 01000000 |
| Color control characteristic 2 | CLRMN | 30 | C-3 | Measure V3: the output amplitude when the color control is minimum. Calculate CLRMN as $CLRMN = 20 \times \log (V1/V3)$. | TR28: Saturation 00000000 |
| Color control sensitivity | CLRSE | 30 | C-3 | Measure V4: the output amplitude when the color control is 90, and V5: the output amplitude when the color control is 38. Calculate CLRSE from the following formula. $CLRSE = 100 \times (V4 - V5)/(V2 \times 52)$ | TR24: Saturation 01011010 Saturation 00100110 |
| Tint center | TINCEN | 30 | C-1 | Measure all sections of the output waveform and calculate the B-Y axis angle | TR23: Tint 00111111 |
| Tint control maximum | TINMAX | 30 | C-1 | Measure all sections of the output waveform, calculate the B-Y axis angle, and calculate TINMAX from the following formula. $TINMAX = \langle \text{the B-Y axis angle} \rangle - TINCEN$ | TR23: Tint 01111111 |
| Tint control minimum | TINMIN | 30 | C-1 | Measure all sections of the output waveform, calculate the B-Y axis angle, and calculate TINMIN from the following formula. $TINMIN = \langle \text{the B-Y axis angle} \rangle - TINCEN$ | TR23: Tint 00000000 |
| Tint control sensitivity | TINSE | 30 | C-1 | Measure A1: the angle when the tint control is 85, and A2: the angle when the tint control is 42, and calculate TINSE from the following formula. $TINSE = (A1 - A2) / 43$ | TR23: Tint 01010101 00101010 |
| Demodulation output ratio R-Y/B-Y | RB | 30 28 | C-3 | Measure Vb: the B _{OUT} output amplitude, and Vr: the R _{OUT} output amplitude. Determine $RB = Vr/Vb$. | TR24: Saturation 01000000 |
| Demodulation output ratio G-Y/B-Y | GB | 29 | C-3 | Measure Vg: the G _{OUT} output amplitude and determine $GB = Vg/Vb$ | TR24: Saturation 01000000 |

Continued on next page.

LA76070

Continued from preceding page.

| Parameter | Symbol | Measurement point | Input signal | Measurement procedure | Bus and other conditions |
|----------------------------------------|---------|-------------------|------------------|---------------------------------------------------------------------------------------------------------------------------------------------------------------------------------------------------------------------------------------------------------------------------------------------------|------------------------------------------------------------------|
| Demodulation angle B-Y/R-Y | ANGBR | 30 28 | C-1 | Measure the B_{OUT} and R_{OUT} output levels, calculate the angles of the B-Y and R-Y axes, and determine ANGBR as <the R-Y angle> – <the B-Y angle>. | |
| Demodulation angle B-Y/G-Y | ANGBG | 29 | C-1 | Measure the G_{OUT} output level, calculate the angle of the G-Y axis, and determine ANGBG as <the G-Y angle> – <the B-Y angle> | |
| Killer operating point | KILL | 30 | C-3 | Gradually lower the input signal level, and measure the input signal level at the point the output level falls under 150 mV p-p | |
| Chrominance VCO free-running frequency | CVCOF | 15 | CIN No signal | Measure the oscillator frequency f , and determine CVCOF from the following formula. $CVCOF = f - 3579545$ (Hz) | |
| Chrominance pull-in range (+) | PULIN + | 30 | C-1 | Gradually lower the input signal subcarrier frequency starting from 3.57545 MHz + 2000 Hz, and measure the frequency when the output waveform locks | |
| Chrominance pull-in range (-) | PULIN - | 30 | C-1 | Gradually raise the input signal subcarrier frequency starting from 3.57545 MHz – 2000 Hz, and measure the frequency when the output waveform locks | |
| Auto flesh characteristic 73° | AF073 | 30 28 | C-4 | With Auto Flesh = 0, measure the level that corresponds to 73° for the B_{OUT} and R_{OUT} output waveforms, and calculate the angle AF073A. With Auto Flesh = 1, determine the angle AF073B in the same way. Calculate AF073 from the following formula. $AF073 = AF073B - AF073A$ | TR22: Auto flesh: 0***** TR22: Auto flesh: 1***** |
| Auto flesh characteristic 118° | AF118 | 30 28 | C-4 | With Auto Flesh = 0, measure the level that corresponds to 118° for the B_{OUT} and R_{OUT} output waveforms, and calculate the angle AF118A. With Auto Flesh = 1, determine the angle AF118B in the same way. Calculate AF118 from the following formula. $AF118 = AF118B - AF118A$ | TR22: Auto flesh: 0***** TR22: Auto flesh: 1***** |
| Auto flesh characteristic 163° | AF163 | 30 28 | C-4 | With Auto Flesh = 0, measure the level that corresponds to 163° for the B_{OUT} and R_{OUT} output waveforms, and calculate the angle AF163A. With Auto Flesh = 1, determine the angle AF163B in the same way. Calculate AF163 from the following formula. $AF163 = AF163B - AF163A$ | TR22: Auto flesh: 0***** TR22: Auto flesh: 1***** |

Video Block - Input Signals and Measurement Conditions

- C IN input signal * chrominance burst signal: 40 IRE
- Y IN input signal 100 IRE: 714 mV
- *0 IRE signal (L-0): Standard NTSC synchronizing signal

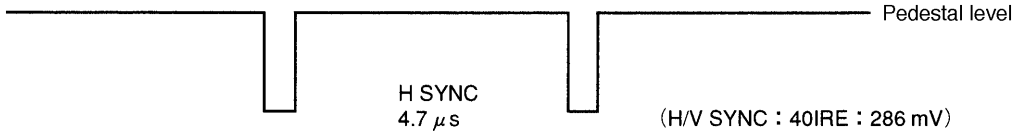

A10412

XIRE signal (L-X)

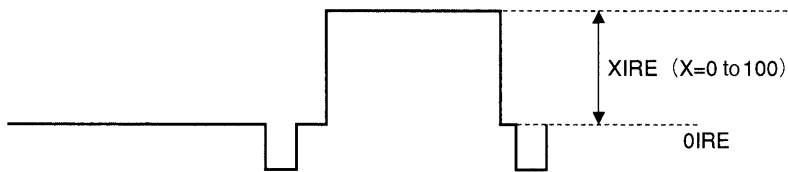

A10413

CW signal (L-CW)

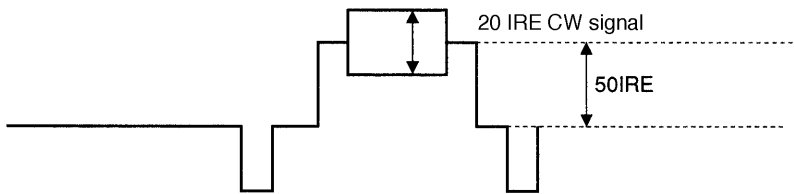

A10414

Black stretch 0 IRE signal (L-BK)

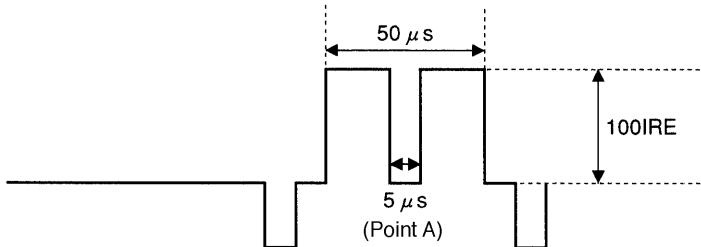

A10415

- R/G/B input signal
- RGB input signal 1 (O-1)

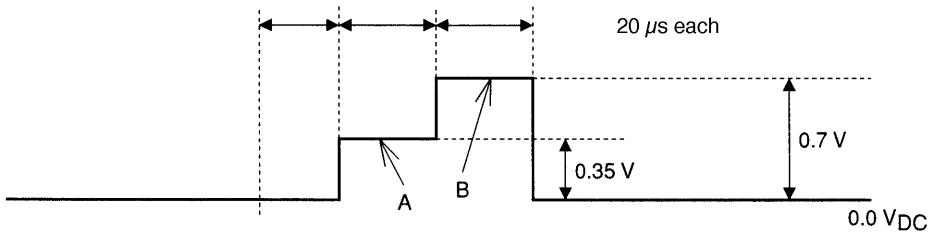

A10416

RGB input signal 2 (O-2)

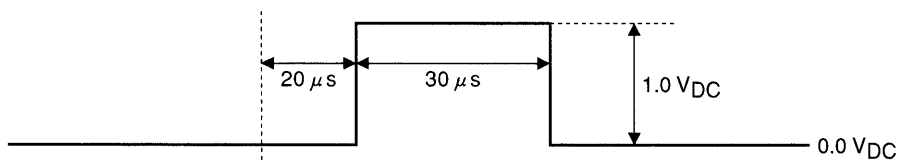

A10417

LA76070

| Parameter | Symbol | Measurement point | Input signal | Measurement procedure | Bus conditions and input signals |
|-------------------------------------------------------|--------------------|-------------------|-----------------------------------------------------------------------------------------------------------------------------------|-----------------------------------------------------------------------------------------------------------------------------------------------------------------------------------|------------------------------------------------------|
| [Video Block] | | | | | |
| Overall video gain (contrast: maximum) | CONT127 | 30 | L-50 | Measure the output signal 50 IRE amplitude (CNTHB V p-p) and calculate CONT127 as $20 \times \log(\text{CNTHB}/0.357)$. | Contrast max 1111111 |
| Contrast adjustment characteristics (normal/maximum) | CONT63 | 30 | L-50 | Measure the output signal 50 IRE amplitude (CNTCB V p-p) and calculate CONT63 as $20 \times \log(\text{CNTCB}/\text{CNTHB})$. | Contrast center 0111111 |
| Contrast adjustment characteristics (minimum/maximum) | CONT0 | 30 | L-50 | Measure the output signal 50 IRE amplitude (CNTLB V p-p) and calculate CONT0 as $20 \times \log(\text{CNTLB}/\text{CNTHB})$. | Contrast min 0000000 |
| Video frequency characteristics | | 30 | | | |
| DC propagation | ClampG | 30 | L-0 | Measure the output signal 0 IRE DC level (BRTPL V) | Brightness min 0000000 Contrast max 1111111 |
| | | | L-100 | Measure the output signal 0 IRE DC level (DRVPH V) and the 100 IRE amplitude (DRVH V p-p), and calculate ClampG as $100 \times (1 + (\text{DRVPH} - \text{BRTPL})/\text{DRVH})$. | Brightness min 0000000 Contrast max 1111111 |
| Y delay | YDLY | 30 | | | |
| Maximum black stretching gain | BKSTmax | 30 | L-BK | Measure the output signal 0 IRE DC level at point A when the black stretch function is defeated (off). Record this value as BKST1 (V). | BKST defeat on (1) |
| | | | L-BK | Measure the output signal 0 IRE DC level at point A when the black stretch is enabled (on). Record this value as BKST2 (V). | BKST defeat off (0) |
| | | | Calculate BKSTmax from the following formula. $\text{BKSTmax} = 2 \times 50 \times (\text{BKST1} - \text{BKST2})/\text{CNTHB}$ | | |
| Sharpness (peaking) | | 30 | L-CW | | |
| | | | L-CW | | |
| | | | L-CW | | |
| Horizontal/vertical blanking output level | RGB _{BLK} | 30 | L-100 | Measure the output signal blanking period DC level. Record that value as RGB _{BLK} V. | |

LA76070

| Parameter | Symbol | Measurement point | Input signal | Measurement procedure | Bus conditions and input signals |
|---------------------------|-------------------|-------------------|--------------|----------------------------------------------------------------------------------------------------------------------------------------------------------------------------------------------------------------------|------------------------------------|
| [OSD Block] | | | | | |
| OSD fast switch threshold | FS _{TH} | 30 | L-0 O-2 | Apply a voltage to pin 36 and determine the pin 36 voltage when the output signal switches to the OSD signal | Pin 35: Apply O-2 |
| Red RGB output level | R _{OSDH} | 28 | L-50 | Measure the output signal 50 IRE amplitude (CNTCR V p-p) | |
| | | | L-0 O-2 | Measure the OSD output amplitude (OSDHR V p-p) | Pin 36: 2.0 V Pin 33: Apply O-2 |
| | | | | Calculate R _{OSDH} as 50 × (OSDHR/CNTCR) | |
| Green RGB output level | G _{OSDH} | 29 | L-50 | Measure the output signal 50 IRE amplitude (CNTCG V p-p) | |
| | | | L-0 O-2 | Measure the OSD output amplitude (OSDHG V p-p) | Pin 36: 2.0 V Pin 34: Apply O-2 |
| | | | | Calculate G _{OSDH} as 50 × (OSDHG/CNTCG) | |
| Blue RGB output level | B _{OSDH} | 30 | L-50 | Measure the output signal 50 IRE amplitude (CNTCB V p-p) | |
| | | | L-0 O-2 | Measure the OSD output amplitude (OSDHB V p-p) | Pin 36: 2.0 V Pin 35: Apply O-2 |
| | | | | Calculate B _{OSDH} as 50 × (OSDHB/CNTCB) | |
| Analog OSD R output level | | 28 | L-0 O-1 | Measure the amplitude of points A (the 0.35 V section in the input signal O-1) and B (the 0.7 V section in the input signal O-1) in the output signal and record those values as RGBLR and RGBHR V p-p, respectively | Pin 36: 2.0 V Pin 33: Apply O-1 |
| Gain matching | R _{RGB} | | | Calculate R _{RGB} as RGBLR/CNTCR | |
| Linearity | LR _{RGB} | | | Calculate LR _{RGB} as 100 × (RGBLR/RGBHR) | |
| Analog OSD G output level | | 29 | L-0 O-1 | Measure the amplitude of points A (the 0.35 V section in the input signal O-1) and B (the 0.7 V section in the input signal O-1) in the output signal and record those values as RGBLG and RGBHG V p-p, respectively | Pin 36: 2.0 V Pin 34: Apply O-1 |
| Gain matching | G _{RGB} | | | Calculate G _{RGB} as RGBLG/CNTCG | |
| Linearity | LG _{RGB} | | | Calculate LG _{RGB} as 100 × (RGBLG/RGBHG) | |
| Analog OSD B output level | | 30 | L-0 O-1 | Measure the amplitude of points A (the 0.35 V section in the input signal O-1) and B (the 0.7 V section in the input signal O-1) in the output signal and record those values as RGBLB and RGBHB V p-p, respectively | Pin 36: 2.0 V Pin 35: Apply O-1 |
| Gain matching | B _{RGB} | | | Calculate B _{RGB} as RGBLB/CNTCB | |
| Linearity | LB _{RGB} | | | Calculate LB _{RGB} as 100 × (RGBLB/RGBHB) | |

| Parameter | Symbol | Measurement point | Input signal | Measurement procedure | Bus conditions and input signals |
|----------------------------------------------|--------|-------------------|--------------|-----------------------------------------------------------------------------------------------------------------------------------------------------------------------|----------------------------------|
| [RGB Output Block] (Cutoff and Drive Blocks) | | | | | |
| Brightness control (normal) | BRT63 | 28 | L-0 | Measure the output signal 0 IRE DC levels for the R output (28), G output (29), and B output (30). Record these values as BRTPCR, BRTPCG, and BRTPCB V, respectively. | Contrast max 1111111 |
| | | 29 | | | |
| | | 30 | | | |
| (max) | BRT127 | 30 | | Measure the output signal 0 IRE DC levels for the B output (30). Record this value as BRTPHB. | Brightness max 1111111 |
| | | | | Calculate BRT127 as 50 × (BRTPHB – BRTPCB)/CNTHB | |
| (min) | BRT0 | | | Measure the output signal 0 IRE DC levels for the B output (30). Record this value as BRTPLB. | Brightness min 0000000 |
| | | | | Calculate BRT0 as 50 × (BRTPLB – BRTPCB)/CNTHB | |

LA76070

| Parameter | Symbol | Measurement point | Input signal | Measurement procedure | Bus and other conditions |
|----------------------------------------------|-----------|-------------------|--------------|-----------------------------------------------------------------------------------------------------------------------------------------------------------------------------------------------|-----------------------------------------------------------------------------------------------------------------------------------------------------------------------------------------------|
| [RGB Output Block] (Cutoff and Drive Blocks) | | | | | |
| (minimum) | Vbias0 | 28 | L-50 | Measure the output signal 0 IRE DC levels for the R output (pin 28), G output (pin 29), and B output (pin 30). Record these values as Vbias0*(V). Here, * is R, G, and B, respectively. | Contrast max 1111111 |
| (maximum) | Vbias127 | | | Measure the output signal 0 IRE DC levels for the R output (pin 28), G output (pin 29), and B output (pin 30). Record these values as Vbias128*(V). Here, * is R, G, and B, respectively. | R bias max 1111111 G bias max 1111111 B bias max 1111111 Contrast max 1111111 |
| Bias (cutoff) control | | | | | |
| Bias (cutoff) control resolution | Vbiasns | 29 | | Measure the output signal 0 IRE DC levels for the R output (pin 28), G output (pin 29), and B output (pin 30). Record these values as BAS80*. Here, * is R, G, and B, respectively. | R bias: 1010000 G bias: 1010000 B bias: 1010000 Contrast max 1111111 |
| | | 30 | | Measure the output signal 0 IRE DC levels for the R output (pin 28), G output (pin 29), and B output (pin 30). Record these values as BAS48*(V). Here, * is R, G, and B, respectively. | R bias: 0110000 G bias: 0110000 B bias: 0110000 Contrast max 1111111 |
| Vbiasns* = (BAS80* - BAS48*)/32 | | | | | |
| Drive adjustment: Maximum output | RGBout127 | 28 | L-100 | Measure the output signal 100 IRE amplitudes for the R output (pin 28), G output (pin 29), and B output (pin 30). Record these values as DRVH* (V p-p). Here, * is R, G, and B, respectively. | Contrast max 1111111 Brightness min 0000000 |
| Output attenuation | RGBout0 | | | 29 | Measure the output signal 100 IRE amplitudes for the R output (pin 28), G output (pin 29), and B output (pin 30). Record these values as DRVL* (V p-p). Here, * is R, G, and B, respectively. |
| | | 30 | | | |
| RGBout0* = 20 × log (DRVH*/DRVL*) | | | | | |

Deflection Block - Input Signals and Measurement Conditions

Unless otherwise indicated, set up the following conditions for each of the following measurements.

1. VIF and SIF blocks: No signal
2. C input: No signal
3. SYNC input: Horizontal and vertical composite synchronizing signal (40 IRE and other conditions, such as timing, must conform to the FCC broadcast standards.)

Caution: The burst and chrominance signals must not be below the pedestal level.

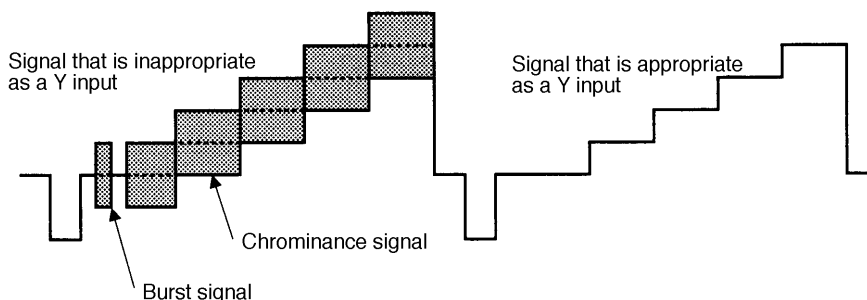

A10418

4. Bus control conditions: All conditions set to the initial conditions unless otherwise specified.
5. The delay between the rise of the horizontal output (the pin 23 output) and the rise of the F.B.P IN (the pin 24 input) must be 9 μ s.
6. Unless otherwise specified, pin 25 (the X-ray protection circuit input) must be connected to ground.

Caution:

Perform the following operation if horizontal pulse output has stopped.

1. The bus data T_ENABLE bit must be temporarily set to 0 and then set to 1.
(If the X-ray protection circuit operates, an IC internal latch circuit will be set. To reset that latch circuit, the T_ENABLE bit must be temporarily set to 0, even if there is no horizontal output signal being output.)

Notes on Video Muting

If horizontal pulse output has stopped, perform the operation described in item 1. above and then set the video mute bit set to 0.

(This is because the video mute bit is forcibly set to the mute setting when the T_ENABLE bit is set to 0 or when the X-ray protection circuit operates. This also applies when power is first applied.)

| Parameter | Symbol | Measurement point | Input signal | Measurement procedure | Bus conditions |
|---------------------------------------------|-------------|-------------------|-------------------------------------------------------|---------------------------------------------------------------------------------------------------------------------------------------------------------------------------------------------------------------------------|----------------|
| [Deflection Block] | | | | | |
| Sync separator circuit sensitivity | Ssync | 37 | SYNC IN: horizontal and vertical synchronizing signal | Gradually lower the level of the synchronizing signal input to Y IN (pin 37) and measure the level of the synchronizing signal at the point synchronization is lost | |
| Horizontal free-running frequency deviation | ΔfH | 23 | SYNC IN: No signal | Connect a frequency counter to the pin 23 output (Hout) and measure the horizontal free-running frequency. Calculate the deviation from the following formula. $\Delta fH = \text{<measured value>} - 15.734 \text{ kHz}$ | |
| Horizontal pull-in range | fH PULL | 37 | SYNC IN: horizontal and vertical synchronizing signal | Monitor the horizontal synchronizing signal input to Y IN (pin 37) and the pin 23 output (Hout), and measure the pull-in range by modifying the horizontal synchronizing signal frequency | |
| Horizontal pulse output saturation voltage | V Hsat | 23 | SYNC IN: horizontal and vertical synchronizing signal | Measure the voltage during the low-level period in the pin 23 horizontal output pulse | |

LA76070

| Parameter | Symbol | Measurement point | Input signal | Measurement procedure | Bus conditions |
|--------------------------------------------------|-------------------|-------------------|----------------------------------------------------------|--------------------------------------------------------------------------------------------------------------------------------------------------------------------------------------------------------------------------------------------------------------------------------------------------------|----------------------------------------|
| Horizontal output pulse phase | HPHCEN | 23 37 | SYNC IN: horizontal and vertical synchronizing signal | <p>Measure the delay between the rise of the pin 23 horizontal output pulse and the fall of the Y IN horizontal synchronizing signal</p> <p>A10419</p> | |
| Horizontal position adjustment range | HPHrange | 23 37 | SYNC IN: horizontal and vertical synchronizing signal | <p>Measure the delay between the rise of the pin 23 horizontal output pulse and the fall of the Y IN horizontal synchronizing signal when HPHASE is set to 0 and when it is set to 7, and calculate the difference between those measurements and HPHCEN</p> <p>A10420</p> | Hphase: 000 Hphase: 111 |
| Horizontal position adjustment maximum deviation | HPHstep | 23 37 | SYNC IN: horizontal and vertical synchronizing signal | <p>Measure the delay between the rise of the pin 23 horizontal output pulse and the fall of the SYNC IN horizontal synchronizing signal as HPHASE is set to each value from 0 to 7, and calculate the amount of the change at each step. Find the step size with the largest change.</p> <p>A10421</p> | Hphase: 000 to Hphase: 111 |
| X-ray protection circuit operating voltage | V _{XRAY} | 23 25 | SYNC IN: horizontal and vertical synchronizing signal | <p>Connect a DC voltage source to pin 25 and gradually increase the voltage starting at 0 V. Measure the pin 25 DC voltage at the point that the pin 23 horizontal pulse output stops.</p> | |

LA76070

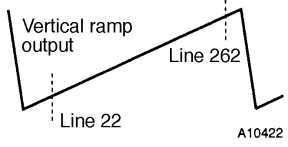
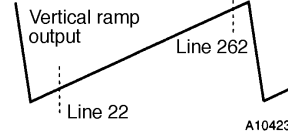
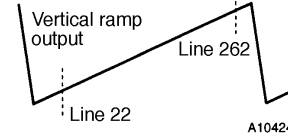
| Parameter | Symbol | Measurement point | Input signal | Measurement procedure | Bus conditions |
|------------------------------------|---------|-------------------|----------------------------------------------------------------------|---------------------------------------------------------------------------------------------------------------------------------------------------------------------------------------------------------------------------------------------------------------------------|-------------------|
| [Vertical screen Size Adjustment] | | | | | |
| Vertical ramp output amplitude @32 | Vsize32 | 17 | SYNC IN: horizontal and vertical synchronizing signal | Monitor the pin 17 vertical ramp output and measure the voltages at the line 22 and line 262. Calculate Vsize32 from the following formula. $Vsize32 = Vline262 - Vline22$  | |
| Vertical ramp output amplitude @0 | Vsize0 | 17 | SYNC IN: horizontal and vertical synchronizing signal | Monitor the pin 17 vertical ramp output and measure the voltages at the line 22 and line 262. Calculate Vsize32 from the following formula. $Vsize0 = Vline262 - Vline22$  | VSIZE: 0000000 |
| Vertical ramp output amplitude @63 | Vsize63 | 17 | SYNC IN: horizontal and vertical synchronizing signal | Monitor the pin 17 vertical ramp output and measure the voltages at the line 22 and line 262. Calculate Vsize32 from the following formula. $Vsize63 = Vline262 - Vline22$  | VSIZE: 1111111 |

LA76070

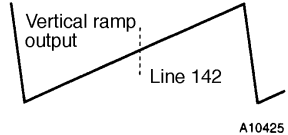
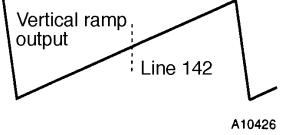
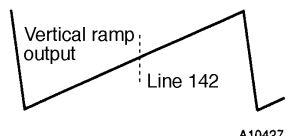
| Parameter | Symbol | Measurement point | Input signal | Measurement procedure | Bus conditions |
|---------------------------------------|--------|-------------------|----------------------------------------------------------------------|----------------------------------------------------------------------------------------------------------------------------------------------------------------------------|----------------|
| [Vertical screen Position Adjustment] | | | | | |
| Vertical ramp DC voltage @32 | Vdc32 | 17 | SYNC IN: horizontal and vertical synchronizing signal | Monitor the pin 17 vertical ramp output and measure the voltage at line 142  | |
| Vertical ramp DC voltage @0 | Vdc0 | 17 | SYNC IN: horizontal and vertical synchronizing signal | Monitor the pin 17 vertical ramp output and measure the voltage at line 142  | VDC: 0000000 |
| Vertical ramp DC voltage @63 | Vdc63 | 17 | SYNC IN: horizontal and vertical synchronizing signal | Monitor the pin 17 vertical ramp output and measure the voltage at line 142  | VDC: 1111111 |

LA76070

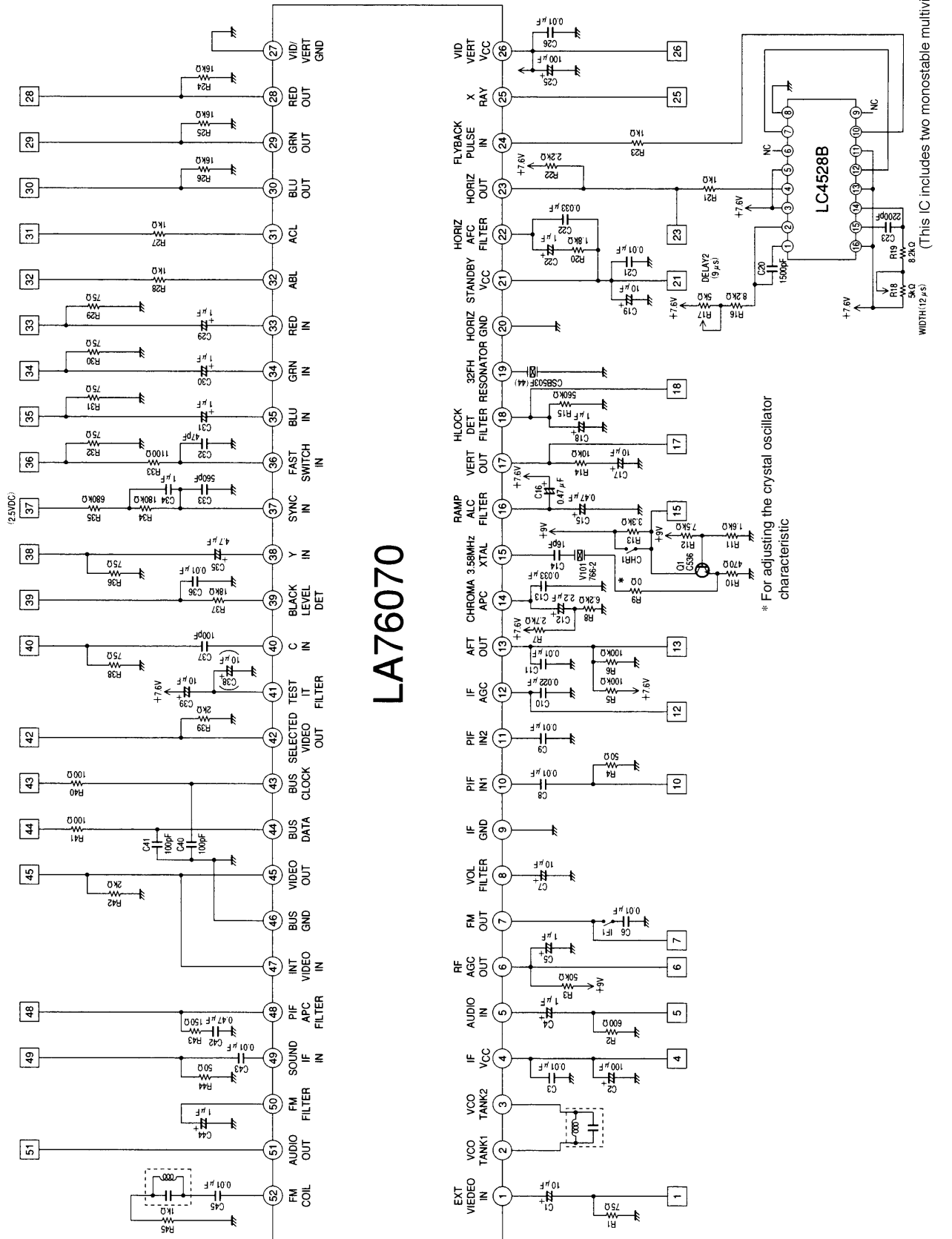

- Specifications of any and all SANYO products described or contained herein stipulate the performance, characteristics, and functions of the described products in the independent state, and are not guarantees of the performance, characteristics, and functions of the described products as mounted in the customer's products or equipment. To verify symptoms and states that cannot be evaluated in an independent device, the customer should always evaluate and test devices mounted in the customer's products or equipment.
- SANYO Electric Co., Ltd. strives to supply high-quality high-reliability products. However, any and all semiconductor products fail with some probability. It is possible that these probabilistic failures could give rise to accidents or events that could endanger human lives, that could give rise to smoke or fire, or that could cause damage to other property. When designing equipment, adopt safety measures so that these kinds of accidents or events cannot occur. Such measures include but are not limited to protective circuits and error prevention circuits for safe design, redundant design, and structural design.
- In the event that any or all SANYO products (including technical data, services) described or contained herein are controlled under any of applicable local export control laws and regulations, such products must not be exported without obtaining the export license from the authorities concerned in accordance with the above law.
- No part of this publication may be reproduced or transmitted in any form or by any means, electronic or mechanical, including photocopying and recording, or any information storage or retrieval system, or otherwise, without the prior written permission of SANYO Electric Co., Ltd.
- Any and all information described or contained herein are subject to change without notice due to product/technology improvement, etc. When designing equipment, refer to the "Delivery Specification" for the SANYO product that you intend to use.
- Information (including circuit diagrams and circuit parameters) herein is for example only; it is not guaranteed for volume production. SANYO believes information herein is accurate and reliable, but no guarantees are made or implied regarding its use or any infringements of intellectual property rights or other rights of third parties.

This catalog provides information as of July, 1999. Specifications and information herein are subject to change without notice.