

SANYO	No.3849B	LA7470M,7470V
	Video camera 2-channel microphone AMPs	

The LA7470M and the LA7470V are ICs with on-chipped microphone amplification peripherals for stereo video camera applications. They show excellent characteristics in space design.

Features

- Low-noise (Input $0.75\mu\text{Vrms}$, JIS-A filter, $R_g = 1\text{k}\Omega$)
- 2 inputs (internal/external microphones)
- On-chip HPF (with a through switch) for internal MIC wind noise elimination
- On-chip external power supply (with a current limiter)
- Capacitors = less than $1.0\mu\text{F}$ (excluding ripple filters)
- Stereo/monoral detect output pin for external MICs

Functions

- 2-channel microphone AMPs
- Internal MIC power supply (2 channels)
- Internal/external MIC select switch
- External power supply (with a current limiter)
- HPF (with a through switch)
- External MIC stereo/monoral detector
- Ripple filter

Maximum Ratings at $T_a = 25^\circ\text{C}$

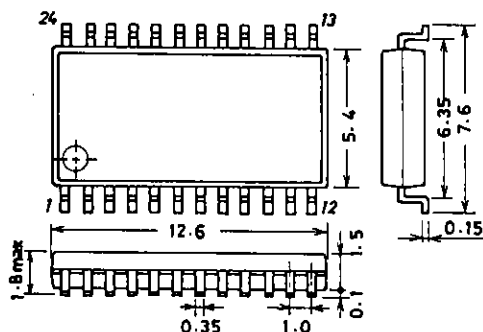
Maximum Supply Voltage	$V_{CC\text{ max}}$		7.0	V	unit
Allowable Power Dissipation	$P_d\text{ max}$	$T_a = 65^\circ\text{C}$	300	mW	
Operating Temperature	T_{op}		-10 to +65	$^\circ\text{C}$	
Storage Temperature	T_{stg}		-55 to +150	$^\circ\text{C}$	

Operating Conditions at $T_a = 25^\circ\text{C}$

Recommended Supply Voltage	V_{CC}		5.0	V	unit
Operating Voltage Range	$V_{CC\text{ op}}$		4.5 to 5.5	V	

Package Dimensions 3112

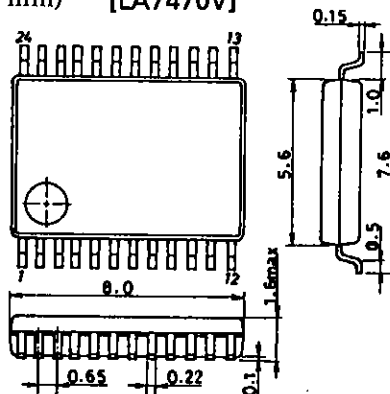
(unit : mm) [LA7470M]



SANYO : MFP24S

Package Dimensions 3175A

(unit : mm) [LA7470V]

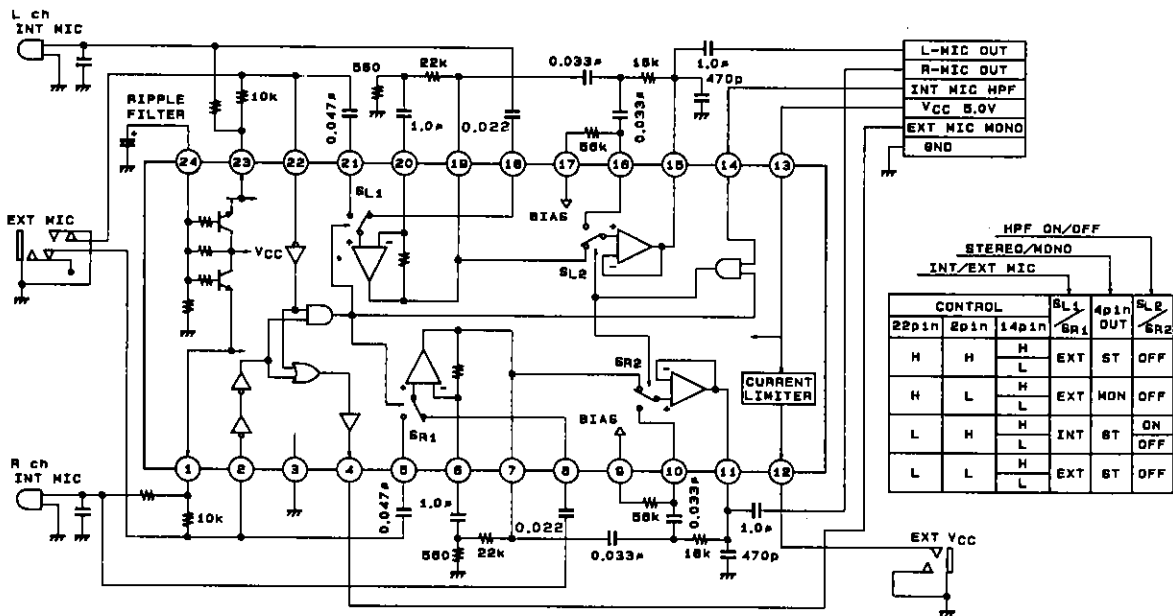


SANYO : SSOP24

LA7470M,7470V

Operating Characteristics at $T_a = 25^\circ\text{C}$, $V_{CC} = 5.0\text{V}$, $f = 1.0\text{kHz}$, $R_L = 10\text{k}\Omega$			min	typ	max	unit
Current Dissipation	I_{CC}	INT MIC HPF-ON	4.0	5.5	7.0	mA
Voltage Gain	VG	INT/EXT MIC IN, HPF-ON/OFF, L/Rch	29.8	30.3	30.8	dB
Total Harmonic Distortion	THD	INT/EXT MIC IN, L/Rch HPF-ON/OFF, $V_o = 300\text{mV}_{\text{rms}}$		0.05	0.2	%
Maximum Output	V_{OM}	INT/EXT MIC IN, L/Rch HPF-ON/OFF, THD = 1.0%	1.0	1.4		V_{rms}
Output Noise Voltage 1	V_{NO1}	INT MIC IN, $R_g = 1.0\text{k}\Omega$ HPF-ON/OFF, JIS-A Filter		30	42	μV_{rms}
Output Noise Voltage 2	V_{NO2}	EXT MIC IN, $R_g = 1.0\text{k}\Omega$ JIS-A Filter		25	40	μV_{rms}
Input Switch Cross Talk	SW_{CR}	INT MIC IN \rightarrow EXT MIC IN ($R_g = 1\text{k}\Omega$) $f = 10\text{kHz}$, L/Rch		76	70	dB
Inter-channel Cross Talk	CH_{CR}	INT/EXT MIC, HPF-ON/OFF Lch \rightarrow Rch, Rch \rightarrow Lch, $f = 10\text{kHz}$		76	70	dB
Internal MIC Power Supply Output Voltage	V_{INM}	pin1/pin23 DC, $30\text{k}\Omega$ load	2.7	2.85	3.0	V
External Power Supply Output Voltage	V_{EXM}	Pin12 Output Current = 25mA, Pin12 DC	4.0	4.5		V
External Power Supply Limiter Current	I_{LIM}	Pin12 Grounded, Pin12 Output Current			30	mA
Input Select Control Voltage	CTL_{IN}	H level, pin2/pin22 DC L level, pin2/pin22 DC	1.3	V_{CC}	0.7	V
HPF Switching Control Voltage	CTL_{HP}	H level, pin14 DC L level, pin14 DC	1.6	V_{CC}	1.0	V
Input Impedance	Z_{IN}	INT/EXT MIC IN, L/Rch	70	85	100	$\text{k}\Omega$
Output Impedance	Z_O	HPF-ON/OFF, L/Rch		100		Ω
AMP Open Gain	VG_o		60	65		dB

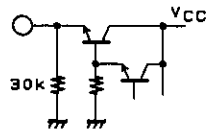
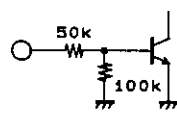
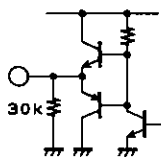
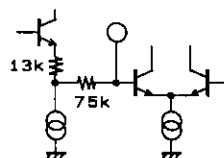
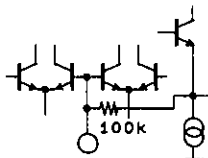
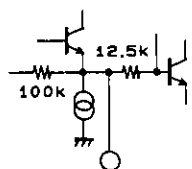
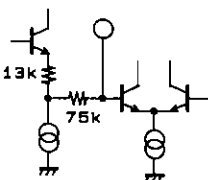
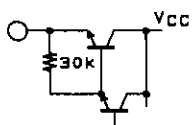
Application circuit (Equivalent Circuit Block Diagram and Peripheral Circuit)



Unit (resistance : Ω , capacitance : F)

LA7470M,7470V

Pin Circuit I/O Circuit (internal equivalent circuit) Unit (resistance : Ω)

Pin No.	Pin Name	Standard DC Voltage	I/O circuit type	Remarks
1, 23	Internal MIC Power Supply Output	2.85		Maximum Drive Current 10mA
2	Input Select Control			
3	GND			
4	External MIC Stereo/Monoral Detector Output	In the Stereo mode 4.28V In the Monoral mode 0V		
5, 21	Internal MIC Input	2.16V		
6, 20	Negative Feedback	2.18V		
7, 19	MIC AMP Output	2.24V		
8, 18	Internal MIC Input	2.16V		
9, 17	Bias	2.85V		Bias for High Pass Filter Input

LA7470M,7470V

Unit (resistance : Ω)

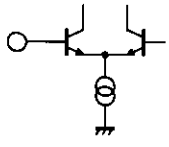
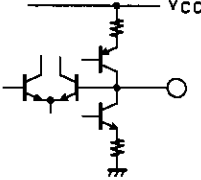
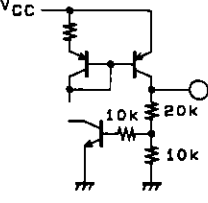
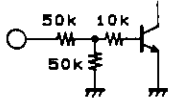
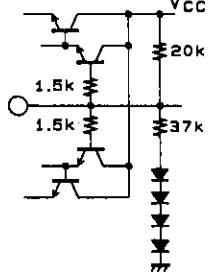
Pin No.	Pin Name	Standard DC Voltage	I/O circuit type	Remarks
10, 16	High Pass Filter Input	2.83V		
11, 15	High Pass Filter and Buffer Output	2.81V		Output Impedance = 100Ω
12	External Power Supply Output	4.5V (25mA Source Current)		
13	VCC			
14	HPF Control	2.85V		
24	Ripple Filter	4.18V		Should be grounded to the GND through an electrolytic capacitor. See Fig. 2 for ripple elimination

Fig. 1. Frequency characteristics

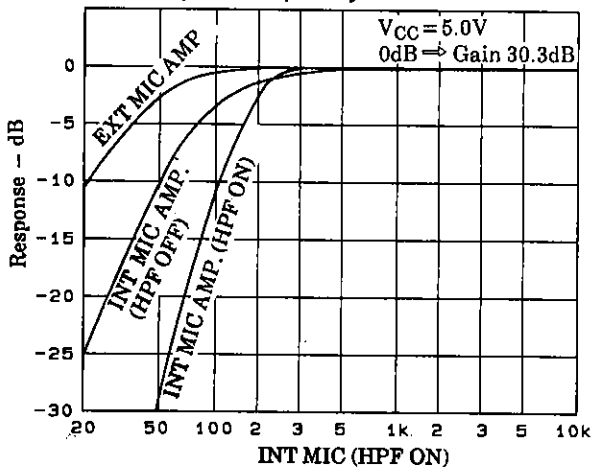
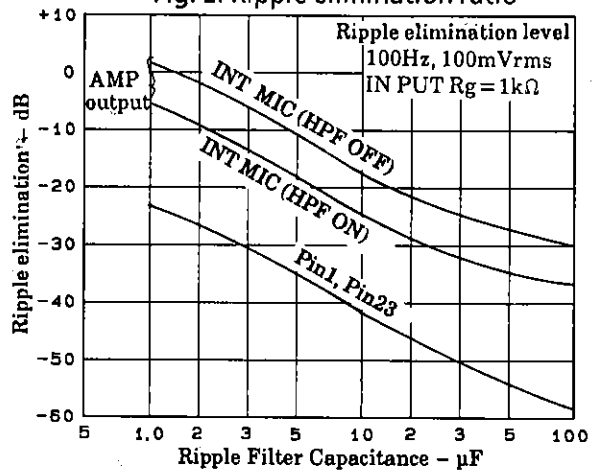


Fig. 2. Ripple elimination ratio



- No products described or contained herein are intended for use in surgical implants, life-support systems, aerospace equipment, nuclear power control systems, vehicles, disaster/crime-prevention equipment and the like, the failure of which may directly or indirectly cause injury, death or property loss.
- Anyone purchasing any products described or contained herein for an above-mentioned use shall:
 - ① Accept full responsibility and indemnify and defend SANYO ELECTRIC CO., LTD., its affiliates, subsidiaries and distributors and all their officers and employees, jointly and severally, against any and all claims and litigation and all damages, cost and expenses associated with such use:
 - ② Not impose any responsibility for any fault or negligence which may be cited in any such claim or litigation on SANYO ELECTRIC CO., LTD., its affiliates, subsidiaries and distributors or any of their officers and employees jointly or severally.
- Information (including circuit diagrams and circuit parameters) herein is for example only; it is not guaranteed for volume production. SANYO believes information herein is accurate and reliable, but no guarantees are made or implied regarding its use or any infringements of intellectual property rights or other rights of third parties.

This catalog provides information as of **March, 1996**. Specifications and information herein are subject to change without notice.