

LA7285, 7285M**SANYO****VCR Audio Signal Recording
and Playback Processor****Overview**

The LA7285 and LA7285M include on chip all functions required for the record and playback of VCR audio signals. In addition, the inclusion of a switching circuit for switching between tuner and line input in addition to the circuits provided by earlier ICs makes the LA7285 truly optimal for audio VCR products.

Functions

- Equalizer amplifier
- Line amplifier
- Recording/playback switch
- Recording amplifier
- Mute
- SP, LP, EP switch
- Ripple filter
- ALC
- Tape head switch
- Line/tuner input switch

Features

- Built-in input switching circuit (for the line and tuner inputs).
- Smaller package leaves large space for other components.
- Equalizer input/output capacitors not required.
- Low gain variation eliminates the need for external adjustment.
- Supply voltage : 9V and 12V operation.

Specifications**Maximum Ratings at Ta = 25°C**

Parameter	Symbol	Conditions	Ratings	Unit
Maximum supply voltage	V_{CCmax}		14	V
Pin1 input voltage	V_{IN1}	DC	+65	Vp-p
Pin1 input current	V_{IN1}		±1.5	mA
Allowable power dissipation	$P_d max$	$T_a \leq 65^\circ C$	400	mW
Operating temperature	T_{opr}		-10 to +65	°C
Storage temperature	T_{stg}		-55 to +150	°C

Operating Conditions at Ta=25°C

Parameter	Symbol	Conditions	Ratings	Unit
Recommended supply voltage	V_{CC}		12	V
Operating supply voltage range	V_{CCop}		8.5 to 12.75	V

Package Dimensions

unit:mm

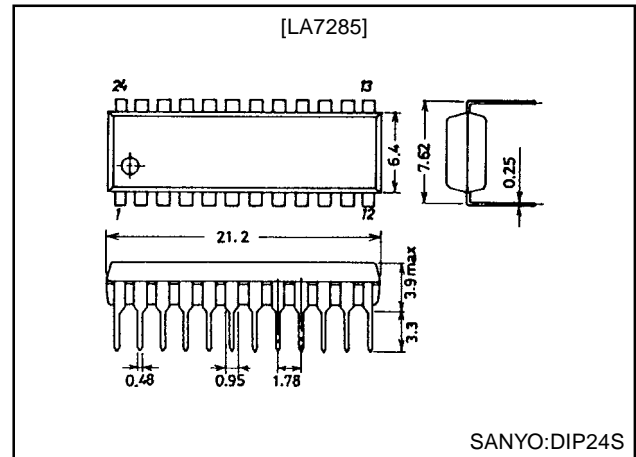
3067-DIP24S

unit:mm

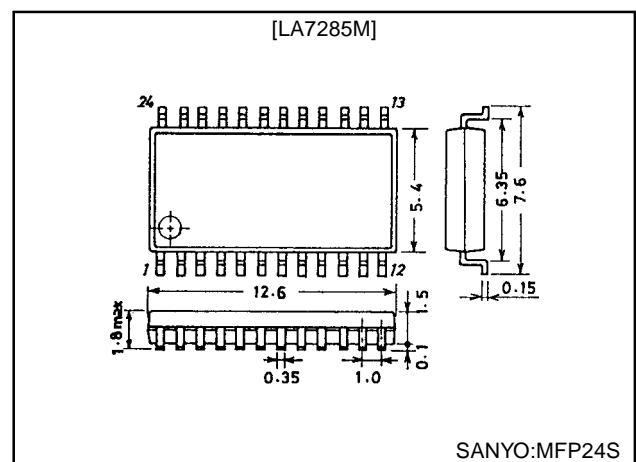
3112-MFP24S

LA7285, 7285M

Operating Characteristics at Ta=25°C, V_{CC}=12V, f=1kHz, 0dBV : 1.0 Vrms

Parameter	Symbol	Conditions	Ratings			Unit
			min	typ	max	
Current consumption (EE)	I _{CCE}	No signal	9.5	13.0	16.5	mA
Current consumption (PB)	I _{CCP}	No signal	9.5	13.0	16.5	mA
Current consumption (REC)	I _{CCR}	No signal	8.0	11.0	14.0	mA
[Equalizer amplifier]						
Open-circuit voltage gain	V _{GOE}	V _O =-7dBV	66.0	71.0		dB
Equivalent input noise voltage	V _{NIE}	Rg=2.2kΩ, DIN Audio filter		1.2	1.8	μVrms
[Line amplifier]						
Voltage gain (PB input)	V _{GLP}	V _O =-7dBV	21.0	21.5	22.0	dB
Voltage gain (EE, LINE input)	V _{GLE} , V _{GLL}	V _O =-7dBV	21.0	21.5	22.0	dB
Total harmonic distortion	THD _L	V _O =-7dBV		0.05	0.3	%
Output noise voltage	V _{NOL}	Rg=2.2kΩ, DIN Audio filter		-72	-66	dBV
Maximum output voltage	V _{OML}	THD=1%	1.5	2.1		Vrms
Output voltage when ALC is on	V _{OA}	V _{IN} =-27dBV	-8.0	-7.0	-6.0	dBV
ALC effect	ALC	V _{IN} =-27dBV to -7dBV		1.0	3.0	dB
Distortion when ALC is on	THD _A	V _{IN} =-27dBV		0.05	0.6	%
[Recording amplifier]						
Voltage gain (open)	V _{GOR}	V _O =-7dBV	47.0	52.0		dB
Voltage gain (colse)	V _{GOR}	V _O =-7dBV	12.5	13.0	13.5	dB
Total harmonic distortion	THD _R	V _O =-7dBV		0.1	0.3	%
Maximum output voltage	V _{OMR}	THD=1%	1.5	2.0		Vrms
[Mute circuit]						
On voltage	V _{MON}	Pin 23 DC voltage	2.5		6.0	V
Off voltage	V _{MOFF}	Pin 23 DC voltage	0		1.5	V
Mute attenuation (PB,EE)	M _{P,ME}		80	90		dB
Mute attenuation (REC)	M _R		65	75		dB
[EP, LP, SP switch circuit]						
EP mode hold voltage	V _{EE}	Pin 21 DC voltage	3.6		6.0	V
LP mode hold voltage	V _{EL}	Pin 21 DC voltage	1.8		2.6	V
SP mode hold voltage	V _{ES}	Pin 21 DC voltage	0		1.0	V
[Line/Tuner PB switch circuit]						
Line mode hold voltage	V _{LL}	Pin 22 DC voltage	3.6		6.0	V
Tuner mode hold voltage	V _{LT}	Pin 22 DC voltage	1.8		2.6	V
PB mode hold voltage	V _{LP}	Pin 22 DC voltage	0		1.0	V
[REC, EE switch circuit]						
REC mode hold voltage	V _{RR}	Pin 24 DC voltage	3		V _{CC}	V
EE mode hold voltage	V _{RE}	Pin 24 DC voltage	0		1.0	V
[Head Select Switch]						
Pin 1 on resistance	R _{ON1}	I1=±1mA		20	30	Ω
Pin 2 on resistance	R _{ON2}	I2=±1mA		5	10	Ω
Pin 2 input voltage	V _{IN1}	Ta=65°C, f=80kHz (sin), I _{LK} =10μA			±45	V

LA7285, 7285M

Switch Operation Table

Test item (symbol)	SW1	SW2	SW3	SW4	SW5	V _M	V _L	V _R	Input	Measure
I _{CCE}	2	1	1	2	1	GND	5V	GND	–	A
I _{CCP}	2	1	1	2	1	GND	GND	GND	–	A
I _{CCR}	2	1	1	2	1	GND	5V	5V	–	A
V _{GOE}	1	2	3	2	1	GND	GND	GND	V _{IN1}	V _{O1}
V _{NIE}	2	1	3	2	1	GND	GND	GND	–	V _{O1}
V _{GLP} , THD _L , V _{OML}	2	1	2	2	1	GND	GND	GND	V _{IN2}	V _{O2}
V _{GLE} , V _{GLL}	2	1	1	2	1	GND	2.5V, 5V	GND	V _{IN3} , V _{IN4}	V _{O2}
V _{NOL}	2	1	3	2	1	GND	5V	GND	–	V _{O2}
V _{OA} , ALC, THD _A	2	1	3	1	1	GND	2.5V, 5V	GND	V _{IN3} , V _{IN4}	V _{O2}
V _{GOR}	2	1	3	2	2	GND	5V	GND	V _{IN5}	V _{O3}
V _{GOR} , THD _R , V _{OMR}	2	1	3	2	1	GND	5V	GND	V _{IN5}	V _{O3}
M _P	1	1	1	2	1	5V	GND	GND	V _{IN1}	V _{O2}
M _R	2	1	1	2	1	5V	5V	GND	V _{IN5}	V _{O3}
M _E	2	1	3	2	1	5V	5V	GND	V _{IN2}	V _{O2}

Sample Application Circuit

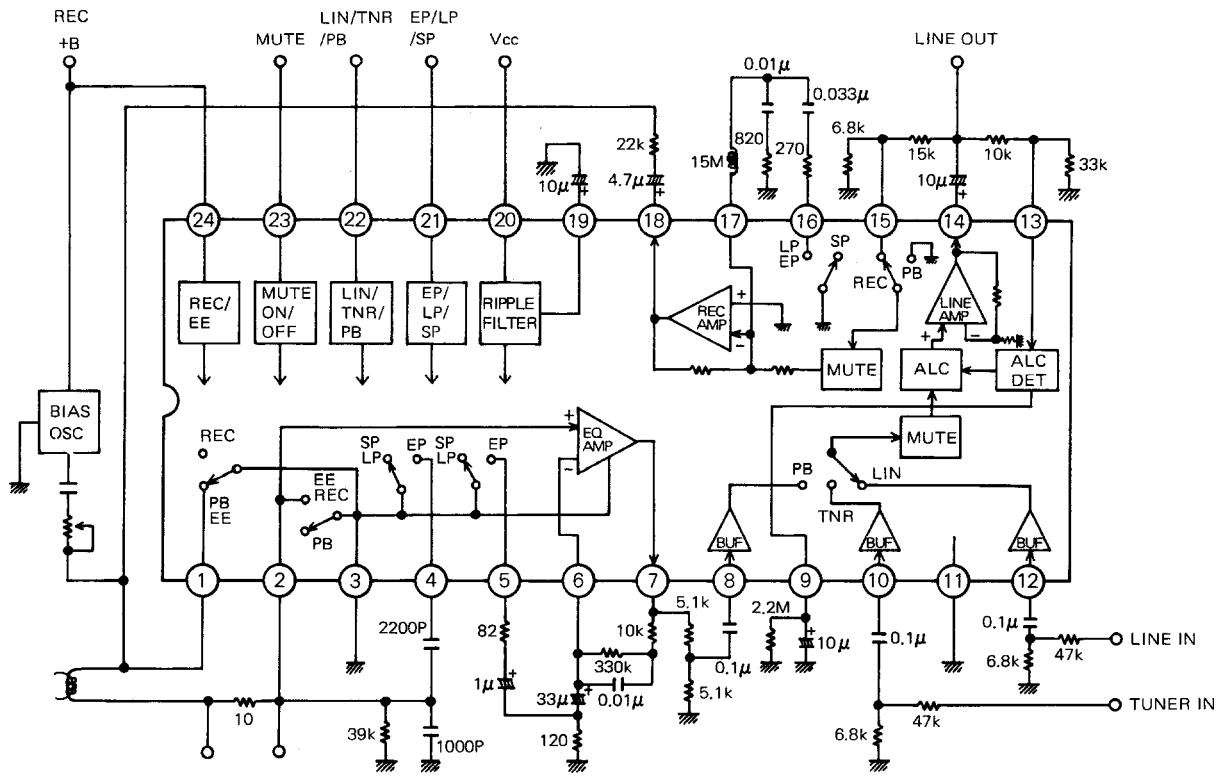

Unit (resistance:Ω, capacitance:F)

LA7285, 7285M

Pin Function

Unit (resistance:Ω)

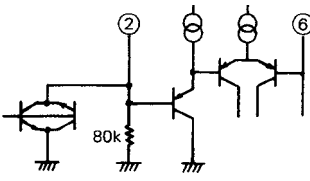
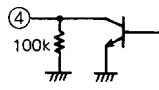
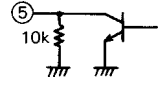
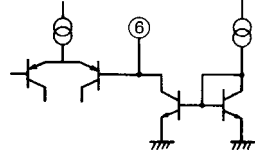
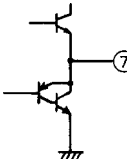
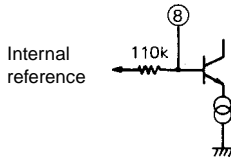
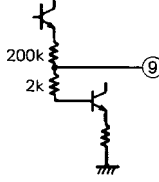
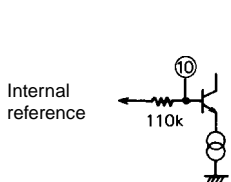
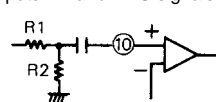
Pin No.	Function name	Internal circuit for pin	Description of function
1	Head switch1 (high withstand voltage)		EE, PB → off, REC → off On resistance → 20Ω (typ) Withstand voltage when off → ±45V (f=80kHz)
2	EQ AMP input and Head switch2		Input impedance for playback signal input from head → 80kΩ (typ) EE, REC → on PB → off On resistance → 5Ω (typ)
3	GND		GND for pin 1 head switch and Equalizer Amplifier only
4	EP mode switch1		Use to change tape heads and resonant frequency. On resistance → 15Ω (typ) Input impedance → 10kΩ (typ) (EP mode)
5	EP mode switch2		Switches the Playback Equalizer Amplifier high-region frequency voltage gain. On resistance → 15kΩ (typ) Input impedance → 10kΩ (typ) (EP mode)
6	EQ AMP NFB		Equalizer Amplifier negative feedback pin
7	EQ AMP output		
8	LINE AMP PB input		Inputs the playback signal from the Equalizer Amplifier. Because the input impedance is as high as 110kΩ, a 0.1μF ceramic capacitor can be used for the coupling capacitor on pin 8.
9	ALC FILTER		Wave detection is performed when connected to GND through a capacitor. In addition, the attack and recovery time is set by C and R time constants.
10	TUNER input		Inputs EE and REC signals.  The reference input is set by resistors R1 and R2. The amplifier gain is fixed at 21.5dB. In addition, because the input impedance is as high as 110kΩ, a 0.1μF ceramic capacitor can be used for the coupling capacitor on pin 10.
11	GND		GND for all circuit blocks except the head switch and Equalizer Amplifier.

Continued to next page.

LA7285, 7285M

Continued from proceeding page.

Unit (resistance:Ω)

Pin No.	Function name	Internal circuit for pin	Description of function
12	LINE input		<p>Inputs EE and RE signals.</p> <p>The reference input is set by resistors R1 and R2. The amplifier gain is fixed at 21.5 dB. In addition, because the input impedance is as high as 110kΩ, a 0.1μF ceramic capacitor can be used for the coupling capacitor on pin 12.</p>
13	ALC input wave detection		<p>Inputs the Line Amplifier output signal. The ALC level is set by the resistors R1 and R2.</p>
14	LINE AMP output		Output impedance → 50Ω (typ)
15	REC AMP input		<p>Inputs the recording signal from Line Amplifier.</p> <p>The recording current is set by the resistors R1 and R2. A coupling capacitor is unnecessary as pin 15 is a zero bias input.</p>
16	LP mode switch		<p>Used to adjust the high-region peaking frequency during recording amplifier in LP mode.</p> <p>On resistance → 15Ω (typ) Input impedance → 50Ω (typ)</p>
17	REC AMP NFB		Recording amplifier negative-feedback input. Used to adjust the high-region peaking frequency of the recording amplifier with an L, C, R network connected to ground.
18	REC AMP output		Output impedance → 40Ω (typ)
19	Ripple filter	<p>Power supply of each circuit block</p>	Ripple rejection is performed when connected to GND through an electrolytic capacitor for the filter.
20	Supply voltage (V _{CC})		V _{CC} max=14V V _{CC} =8.5V to 12.75V
21	EP/LP/SP Control		<p>When the voltage on pin 21 is 3.6V to 6.0V:EP; when 1.8V to 2.6V:LP; when 0V to 1.8V:SP Switch On Pin Number EP mode:4,5,16 LP mode:16</p>

Continued to next page.

LA7285, 7285M

Continued from proceeding page.

Unit (resistance:Ω)

Pin No.	Function name	Internal circuit for pin	Description of function
22	LINE/TUNER/PB Control		When the voltage on pin 22 is 3.6V to 6.0V:LINE; when 1.8V to 2.6V:TUNER when 0V to 1.0V:PB
23	MUTE Control		When the voltage on pin 23 is 2.5V to 6.0V:MUTE on; when 0V to 1.5V:MUTE off
24	REC/EE Control		When the voltage on pin 24 is 2.5V to V_{CC} :REC; when 0V to 1.0V:EE

■ No products described or contained herein are intended for use in surgical implants, life-support systems, aerospace equipment, nuclear power control systems, vehicles, disaster/crime-prevention equipment and the like, the failure of which may directly or indirectly cause injury, death or property loss.

■ Anyone purchasing any products described or contained herein for an above-mentioned use shall:

- ① Accept full responsibility and indemnify and defend SANYO ELECTRIC CO., LTD., its affiliates, subsidiaries and distributors and all their officers and employees, jointly and severally, against any and all claims and litigation and all damages, cost and expenses associated with such use:
- ② Not impose any responsibility for any fault or negligence which may be cited in any such claim or litigation on SANYO ELECTRIC CO., LTD., its affiliates, subsidiaries and distributors or any of their officers and employees jointly or severally.

■ Information (including circuit diagrams and circuit parameters) herein is for example only; it is not guaranteed for volume production. SANYO believes information herein is accurate and reliable, but no guarantees are made or implied regarding its use or any infringements of intellectual property rights or other rights of third parties.

This catalog provides information as of May, 1998. Specifications and information herein are subject to change without notice.