

SANYO

No. 4850

LA7265W**Single-Chip Black and White CCD Camera
Signal Processing IC****Overview**

The LA7265W is a single-chip IC that provides the signal processing required by black and white CCD cameras. This IC is optimal for surveillance cameras, door intercom cameras, and personal computer input cameras due to its ultraminiature package, low current drain, wide dynamic range, and high AGC gain.

Functions

- CCD clamping
- CDS (built-in S/H capacitor)
- IRIS amplifier
- AGC backlight correction
- S-curve gamma correction
- Aperture correction
- Variable setup
- Sync addition
- CCD clipping
- IRIS window
- AGC amplifier
- Gamma correction (0.45, 1.0 and variable)
- 1H interpolation switch
- Aperture low illumination suppression
- Variable W.C.
- 75 Ω drivers

Features

- CCD clamping used to provide a wide dynamic range: The LA7265W can handle a 1.5 Vp-p CCD signal data level.
- Reduced sampling noise provided by a built-in CDS capacitor.
- Variable AGC gain: up to a maximum of 32 dB.
- Backlight correction provided by weighting the iris and AGC levels.
- Three different gamma correction circuits, including S-curve gamma correction
- Knee characteristics are added to the gamma correction to prevent incorrect white rendering in low light situations.
- Automatic aperture adjustment according to the brightness
- Reduced current drain (under 40 mA)
- Ultraminiature package (SQFP48)
- Reduced external component count (50% as compared to the earlier Sanyo LA7261M)
- Reduced number of adjustment points (two points)

Package Dimensions

unit: mm

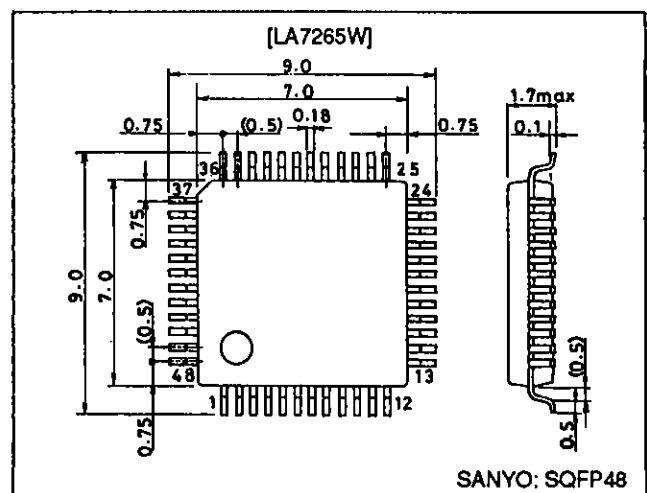
3163A-SQFP48

Specifications

Maximum Ratings at $T_a = 25^\circ\text{C}$

Parameter	Symbol	Conditions	Ratings	Unit
Maximum supply voltage	$V_{CC\text{ max}}$		6.0	V
Allowable power dissipation	$P_d\text{ max}$	$T_a \leq 65^\circ\text{C}$	270	mW
Operating temperature	T_{opr}		-15 to +65	$^\circ\text{C}$
Storage temperature	T_{stg}		-40 to +150	$^\circ\text{C}$

Recommended Operating Conditions at $T_a = 25^\circ\text{C}$

Parameter	Symbol	Conditions	Ratings	Unit
Recommended supply voltage	V_{CC}		5.00	V
Operating supply voltage range	$V_{CC\text{ op}}$		4.75 to 5.25	V

Note: Full IC immersion solder dip mounting techniques should be avoided.

Operating Characteristics at $T_a = 25^\circ\text{C}$, $V_{CC} = 5\text{ V}$

Parameter	Symbol	Conditions	min	typ	max	Unit
CCD clipping high level	CCLIPH	Measure the output voltage difference for inputs of 0 Vp-p and 2 Vp-p. T1 output	1.11	1.22	1.33	V
CCD clipping middle level	CCLIPM	Measure the output voltage difference for inputs of 0 Vp-p and 2 Vp-p. T1 output	0.60	0.91	1.22	V
CCD clipping low level	CCLIPL	Measure the output voltage difference for inputs of 0 Vp-p and 2 Vp-p. T1 output	0.25	0.40	0.50	V
CDS dynamic range	CDS D	Measure the output amplitude for a 2 Vp-p input. T4 output	1.20	1.47		V
CDS hold ability	CDS H	Measure the voltage drop during a 30/fsc hold for a 1 Vp-p input. T1 output		58	88	mV
CDS offset	CDS O	Measure the output noise level. T1 output		11		mV
Sampling noise	CDS N	Stipulated as the absorption remainder for the input dark current difference (200 mV). T1 output		4		mV
CDS linearity	CDS L	Measure the output voltage for a 500 mVp-p input and the output voltage for a 1000 mVp-p input. Stipulates the voltage difference of those two measurements as a gain ratio. T1 output		100		%
IRIS.OUT DC level	IRIS DC	Measure the output voltage (OPB) with no input. T2 output	0.78	1.10	1.42	V
IRIS.OUT pedestal level	IRIS P	Measure the pedestal level with no input. T2 output	-20	+300	+620	mV
IRIS.OUT maximum W.C. level	IRIS WL	Measure the output voltage for a 300 mVp-p input. Stipulated as the difference between that measurement and the IRIS DC level. T2 output	-490	-230	+30	mV
IRIS.OUT gain	IRIS G	Measure the output voltage difference for inputs of 0 Vp-p and 300 mVp-p. Stipulated as the gain with respect to the input. T2 output	7.5	9.0	10.5	dB
IRIS.OUT D range	IRIS D	Measure the output voltage difference for inputs of 0 Vp-p and 2 Vp-p. T2 output	2.05	2.40		V
IRIS.OUT W.C. level initial value	IRIS WT	Measure the output voltage difference for inputs of 0 Vp-p and 2 Vp-p. T2 output	1.25	1.60	1.95	V
AGC DC level (maximum)	AGC DC1	Measure the output voltage (OPB) with no input. T1 output	0.85	2.10	3.50	V
AGC maximum gain (maximum)	AGC G1	Measure the output voltage difference for inputs of 0 Vp-p and 30 mVp-p. Stipulated as the gain with respect to the input. T1 output	26.0	31.0	34.5	dB
AGC maximum gain (typical)	AGC G2	Measure the output voltage difference for inputs of 0 Vp-p and 30 mVp-p. Stipulated as the gain with respect to the input. T1 output	19.5	24.0	27.5	dB
AGC maximum gain (minimum)	AGC G3	Measure the output voltage difference for inputs of 0 Vp-p and 30 mVp-p. Stipulated as the gain with respect to the input. T1 output	13.5	15.5	17.5	dB
AGC DC level (minimum)	AGC DC2	Measure the output voltage (OPB) with no input. T1 output	2.30	2.50	2.70	V

Continued on next page.

LA7265W

Continued from preceding page.

Parameter	Symbol	Conditions	min	typ	max	Unit
AGC minimum gain	AGCLG	Measure the output voltage difference for inputs of 0 Vp-p and 300 mVp-p. Stipulated as the gain with respect to the input. T1 output	-3.5	-2.0	-0.5	dB
AGC minimum D range	AGCLD	Measure the output voltage difference for inputs of 0 Vp-p and 300 mVp-p. T1 output	0.63	1.80		V
AGC W.C. level	AGCWC	Measure the WC voltage for a 300 mVp-p input. T1 output	3.83	4.15	4.47	V
AGC standard voltage	AGCT	Measure the output voltage difference for inputs of 0 Vp-p and 100 mVp-p by adjusting VR4. Stipulated as the VR4 voltage when that difference is 400 mVp-p. T1 output	2.07	2.13	2.19	V
AGC frequency characteristics	AGCF	Stipulated as the gain difference between $f = 10$ MHz and $f = 500$ kHz. T1 output	-6.0	-5.0		dB
AGC linearity	AGCL	Measure the output voltage difference for inputs of 0 mVp-p and 25 mVp-p and the output voltage difference for inputs of 100 mVp-p and 125 mVp-p. Stipulated as the ratio of those two gains. T1 output		95		%
Y1.IN clamping input low level	CLP2L	Increase the lower side input pulse voltage and measure the input pulse level when the clamping level begins to change. T9 output	1.26	1.40		V
AGC detector DC level	DETDC	Measure the output voltage (OPB) with no input. T3 output	2.28	2.38	2.48	V
AGC detector pedestal level	DETP	Measure the pedestal level with no input. T3 output	58	70	82	mV
AGC detector maximum W.C. level	DETWL	Measure the output voltage for a 300 mVp-p input. Stipulated as the difference between that measurement and the detector DC level. T3 output	-150	-110	-70	mV
AGC detector gain	DETG	Measure the output voltage difference for inputs of 0 Vp-p and 300 mVp-p. Stipulated as the gain with respect to the input. T3 output	8.4	8.8	9.2	dB
AGC detector D range	DETD	Measure the output voltage difference for inputs of 0 Vp-p and 1500 mVp-p. T3 output	1.21	1.33		V
AGC detector W.C. level initial value	DEWT	Measure the output voltage difference for inputs of 0 Vp-p and 1500 mVp-p. T3 output	0.70	0.90	1.10	V
AGC control characteristics 1	CONT1	Measure the output DC voltage. T4 output	0.92	1.12	1.22	V
AGC control characteristics 2	CONT2	Measure the output DC voltage. T4 output	0.92	2.00	3.10	V
AGC control characteristics 3	CONT3	Measure the output DC voltage. T4 output	2.90	3.00	3.10	V
$\gamma = 0.45$ DC level	$\gamma 1DC$	Measure the output voltage (OPB) with no input. T5 output	0.94	1.52	2.10	V
$\gamma = 0.45$ characteristics 1	$\gamma 11$	Measure the output voltage difference for inputs of 0 Vp-p and 50 mVp-p. T5 output	80	140	185	mV
$\gamma = 0.45$ characteristics 2	$\gamma 12$	Measure the output voltage difference for inputs of 0 Vp-p and 200 mVp-p. T5 output	180	335	490	mV
$\gamma = 0.45$ characteristics 3	$\gamma 13$	Measure the output voltage difference for inputs of 0 Vp-p and 500 mVp-p. T5 output	320	500	625	mV
$\gamma = 0.45$ knee characteristics	$\gamma 1K$	Measure the output voltage difference for inputs of 0 Vp-p and 1500 mVp-p. T5 output	550	735	880	mV
$\gamma = 0.45$ pedestal level	$\gamma 1P$	Measure the pedestal level with no input. T5 output	-50	0	+50	mV
$\gamma = 0.45$ low clipping level	$\gamma 1L$	Measure the output voltage difference for inputs of 0 Vp-p and -300 mVp-p. T5 output	150	300	450	mV
$\gamma = 0.6$ DC level	$\gamma 3DC$	Measure the output voltage (OPB) with no input. T5 output	0.87	1.49	2.11	V
$\gamma = 0.6$ characteristics 1	$\gamma 31$	Measure the output voltage difference for inputs of 0 Vp-p and 50 mVp-p. T5 output	60	90	105	mV
$\gamma = 0.6$ characteristics 2	$\gamma 32$	Measure the output voltage difference for inputs of 0 Vp-p and 200 mVp-p. T5 output	240	300	360	mV
$\gamma = 0.6$ characteristics 3	$\gamma 33$	Measure the output voltage difference for inputs of 0 Vp-p and 500 mVp-p. T5 output	430	510	590	mV
$\gamma = 0.6$ knee characteristics	$\gamma 3K$	Measure the output voltage difference for inputs of 0 Vp-p and 1500 mVp-p. T5 output	660	805	905	mV
γ .max characteristics 1	$\gamma M1$	Measure the output voltage difference for inputs of 0 Vp-p and 50 mVp-p. T5 output	60	160	260	mV
γ .max characteristics 2	$\gamma M2$	Measure the output voltage difference for inputs of 0 V p-p and 200 mV p-p. T5 output	120	335	465	mV

Continued on next page.

LA7265W

Continued from preceding page.

Parameter	Symbol	Conditions	min	typ	max	Unit
γ .max characteristics 3	γ M3	Measure the output voltage difference for inputs of 0 Vp-p and 500 mVp-p. T5 output	200	515	675	mV
γ .max knee characteristics	γ MK	Measure the output voltage difference for inputs of 0 Vp-p and 1500 mVp-p. T5 output	520	750	930	mV
γ dark clipping characteristics	γ MC	Measure the output voltage difference for inputs of 0 Vp-p and 200 mVp-p. Stipulated as the difference between that measurement and γ M2. T5 output	0	105	280	mV
Y gain control minimum gain	γ 2L	Measure the output voltage difference for inputs of 0 Vp-p and 200 mVp-p. Stipulated as the gain with respect to the input. T5 output	-24	-16	-8	dB
Y gain control maximum gain	γ 2H	Measure the output voltage difference for inputs of 0 Vp-p and 200 mVp-p. Stipulated as the gain with respect to the input. T5 output	10	11	12	dB
Y gain control typical gain	γ 2T	Measure the output voltage difference for inputs of 0 Vp-p and 200 mVp-p. Stipulated as the gain with respect to the input. T5 output	0.2	1.4	2.3	dB
Y gain control D range	γ 2D	Measure the output voltage difference for inputs of 0 Vp-p and 1500 mVp-p. T5 output	1.10	1.53		V
$\gamma = 1$ DC level	γ 2DC	Measure the output voltage (OPB) with no input. T5 output	0.87	1.49	2.11	V
$\gamma = 0.45$ frequency characteristics	γ 1F	Stipulated as the gain difference between 10 MHz and $f = 500$ kHz. T5 output	-5.0	-3.8		dB
$\gamma = 1$ frequency characteristics	γ 2F	Stipulated as the gain difference between 10 MHz and $f = 500$ kHz. T5 output	-2.9	-1.9		dB
$\gamma = 0.6$ frequency characteristics	γ 3F	Stipulated as the gain difference between 10 MHz and $f = 500$ kHz. T5 output	-4.7	-3.7		dB
LSP.SW DC offset	LSPDO	Stipulated as the output voltage difference between SW14 being set to the B and A positions for a 0 Vp-p input. T6 output	-10	0	+10	mV
DL.OUT DC level	LSPDC	Measure the output voltage (OPB) with no input. T6 output	2.30	2.52	2.75	V
LSP.SW gain differential	LSPGD	With SW14 in the B position, measure the output voltage difference for inputs of 0 Vp-p and 500 mVp-p. Perform the same measurement with SW14 in the A position. Stipulated as the difference between the two voltage differences. T6 output	-20	0	+20	mV
DL.OUT gain	LSPG	Measure the output voltage difference for inputs of 0 Vp-p and 500 mVp-p. Stipulated as the gain with respect to the input. T6 output	-0.5	0	+0.5	dB
Aperture clipping standard voltage	APCT	Input a $f = 2$ MHz, 200 mVp-p signal and adjust VR1 so that the output amplitude becomes 44 mVp-p. Determine the VR9 voltage at that time. T7 output	2.35	2.60	2.85	V
Aperture clipping level (maximum)	APCH	Measure the output for an $f = 2$ MHz, 200 mVp-p input signal. T7 output			36	mV
Aperture maximum level	APH	Measure the output for an $f = 2$ MHz, 200 mVp-p input signal. T7 output	100	320	500	mV
Aperture dark point	APDP	Measure the output amplitude for an $f = 2$ MHz, 200 mVp-p input signal. Stipulated as the VR4 setting where the output starts to decrease when VR4 is slowly increased starting at 0 mV. T7 output	1.90	2.06	2.22	V
Aperture dark slope (typical)	APDST	With VR4 set at 0 V and 2.4 V, measure the output gain for an $f = 2$ MHz, 200 mVp-p input signal. Stipulated as the difference between those two gains. T7 output		-1.0		dB
Aperture dark slope (minimum)	APDSL	With VR4 set at 0 V and 2.4 V, measure the output gain for an $f = 2$ MHz, 200 mVp-p input signal. Stipulated as the difference between those two gains. T7 output		0.5		dB
Aperture dark slope (maximum)	APDSH	With VR4 set at 0 V and 2.4 V, measure the output gain for an $f = 2$ MHz, 200 mVp-p input signal. Stipulated as the difference between those two gains. T7 output		-4.0		dB
Aperture Y signal gain	APYG	Measure the output voltage difference for inputs of 0 Vp-p and 300 mVp-p. Stipulated as the gain with respect to the input. T7 output	-1.0	-0.5	0	dB

Continued on next page.

LA7265W

Continued from preceding page.

Parameter	Symbol	Conditions	min	typ	max	Unit
Aperture Y signal D range	APYD	Measure the output voltage difference for inputs of 0 Vp-p and 1200 mVp-p. T7 output	720	785		mV
Aperture YOUT DC level	APYDC	Measure the output voltage (OPB) with no input. T7 output	1.86	1.98	2.10	V
Aperture YOUT frequency characteristics	APYF	Stipulated as the gain difference between 10 MHz and f = 500 kHz. T7 output	-7.2	-6.2		dB
VIDEO-OUT DC level	VODC	Measure (without setup) the pedestal voltage for a 0 Vp-p input. T8 output	1.70	2.00	2.35	V
VIDEO-OUT sync level	VOSY	Measure the pedestal and sink voltage difference for a 0 Vp-p input. T8 output	500	550	630	mV
VIDEO-OUT typical pedestal level	VOPT	Measure (without setup) the setup level for a 0 Vp-p input. T8 output	75	95	125	mV
VIDEO-OUT gain	VOG	Measure the output voltage difference for inputs of 0 Vp-p and 500 mVp-p. Stipulated as the gain with respect to the input. T8 output	7.30	7.75	8.20	dB
VIDEO-OUT low clipping level	VOLC	Measure the output voltage difference for inputs of 0 Vp-p and -300 mVp-p. T8 output	220	260	300	mV
VIDEO-OUT W.C. level (typical)	VOWCT	Measure the output voltage difference for inputs of 0 Vp-p and 1200 mVp-p. T8 output	1.42	1.50	1.58	V
VIDEO-OUT minimum pedestal level	VOPL	Measure the setup level for a 0 Vp-p input. T8 output	-180	-120	-80	mV
VIDEO-OUT maximum pedestal level	VOPH	Measure the setup level for a 0 Vp-p input. T8 output	180	240	280	mV
VIDEO-OUT W.C. level (maximum)	VOWCH	Measure the output voltage difference for inputs of 0 Vp-p and 1200 mVp-p. T8 output	0.85	0.93	1.00	V
VIDEO-OUT D range	VOD	Measure the output voltage difference for inputs of 0 Vp-p and 1200 mVp-p. T8 output	1.80	2.03		V
VIDEO-OUT frequency characteristics	VOF	Stipulated as the gain difference between f = 10 MHz and f = 500 kHz. T8 output	-3	-2		dB
Aperture VIDEO-OUT linearity	VOL	Measure the output voltage difference for inputs of 0 Vp-p and 100 mVp-p and the output voltage difference for inputs of 400 mVp-p and 500 mVp-p. Stipulated as the ratio of those two gains. T8 output		98		%
CDS current drain	ICDS	T10 output	5.50	7.85	10.20	mA
Video system current drain	IVDO	T11 and T15 outputs	16.5	23.5	30.5	mA
75 Ω driver current drain	IDRI	T12 output	4	6	8	mA
V _{REF} reference voltage	V _{REF}	T13 output	1.73	1.80	1.87	V

Switch Conditions

[CDS System]

Symbol	Input signal	Input pulse				Trimmer voltage		Switch		
		S2	S3	S4	S5	VR4	VR5	SW19	SW2	SW1
CCLIPH	S1 = SIG.1	P1	P2	P3	P1	0 V	0 V	B	On	On
CCLIPM	S1 = SIG.1	P1	P2	P3	P1	0 V	0 V	Off	On	On
CCLIPL	S1 = SIG.1	P1	P2	P3	P1	0 V	0 V	A	On	On
CSDS	S1 = SIG.2	P1	P4	P5	5 V DC	—	—	B	—	Off
CDSH	S1 = SIG.1	P1	P6	P7	P1	0 V	0 V	B	On	On
CDSO	No signal	P1	P2	P3	P1	0 V	0 V	B	On	On
CDSN	S1 = SIG.3	P1	P2	P3	P1	0 V	0 V	B	On	On
CDSL	S1 = SIG.1	P1	P2	P3	P1	0 V	0 V	B	On	On

[IRIS Amplifier System]

Symbol	Input signal	Input pulse					Switch	
		S2	S3	S4	S5	S6	SW19	SW3
IRISDC	No signal	P1	P2	P3	P1	P8	B	Off
IRISP	No signal	P1	P2	P3	P1	P8	B	Off
IRISWL	S1 = SIG.1	P1	P2	P3	P1	P8	B	B
IRISG	S1 = SIG.1	P1	P2	P3	P1	P8	B	A
IRISD	S1 = SIG.1	P1	P2	P3	P1	P8	B	A
IRSIWT	S1 = SIG.1	P1	P2	P3	P1	P8	B	Off

[AGC Amplifier System]

Symbol	Input signal	Input pulse				Trimmer voltage		Switch	
		S2	S3	S4	S5	VR4	VR5	SW19	SW2
AGCDC1	No signal	P1	P2	P3	P1	5 V	5 V	B	On
AGCHG1	S1 = SIG.1	P1	P2	P3	P1	5 V	5 V	B	On
AGCHG2	S1 = SIG.1	P1	P2	P3	P1	5 V	—	B	Off
AGCHG3	S1 = SIG.1	P1	P2	P3	P1	5 V	0 V	B	On
AGCDC2	No signal	P1	P2	P3	P1	0 V	0 V	B	On
AGCLG	S1 = SIG.1	P1	P2	P3	P1	0 V	0 V	B	On
AGCLD	S1 = SIG.1	P1	P2	P3	P1	5 V	5 V	B	On
AGCWC	S1 = SIG.1	P1	P2	P3	P1	5 V	5 V	B	On
AGCT	S1 = SIG.1	P1	P2	P3	P1	Scan	—	B	Off
AGCF	S1 = SIG.4	P1	P2	P8	P1	AGCT	—	B	Off
AGCL	S1 = SIG.1	P1	P2	P3	P1	AGCT	—	B	Off

LA7265W

[AGC Detector System]

Symbol	Input signal	Input pulse		Trimmer voltage		Switch	
		S5	S6	VR6	SW5	SW4	SW6
CLP2L	S8 = SIG.5	P1	P8	—	—	B, A	Off
DETDC	No signal	P1	P8	—	Off	B	Off
DETP	No signal	P1	P8	—	Off	B	Off
DETWL	S8 = SIG.5	P1	P8	—	B	A	Off
DETG	S8 = SIG.5	P1	P8	—	A	A	Off
DETD	S8 = SIG.5	P1	P8	—	A	A	Off
DEWT	S8 = SIG.5	P1	P8	—	Off	A	Off
CONT1	No signal	P1	5 V	1.4 V	Off	B	On
CONT2	No signal	P1	5 V	1.9 V	Off	B	On
CONT3	No signal	P1	5 V	2.4 V	Off	B	On

[γ Correction System]

Symbol	Input signal	Input pulse		Trimmer voltage		Switch			
		S5	S6	VR2	VR3	SW4	SW7	SW8	SW9
γ1DC	No signal	P1	P8	0 V	—	B	On	Off	Off
γ11	S8 = SIG.5	P1	P8	0 V	—	A	On	Off	Off
γ12	S8 = SIG.5	P1	P8	0 V	—	A	On	Off	Off
γ13	S8 = SIG.5	P1	P8	0 V	—	A	On	Off	Off
γ1K	S8 = SIG.5	P1	P8	0 V	—	A	On	Off	Off
γ1P	S8 = SIG.5	P1	P8	0 V	—	B	On	Off	Off
γ1L	S8 = SIG.5	P1	P8	0 V	—	A	On	Off	Off
γ3DC	No signal	P1	P8	—	2.54 V	B	Off	Off	On
γ31	S8 = SIG.5	P1	P8	—	2.54 V	A	Off	Off	On
γ32	S8 = SIG.5	P1	P8	—	2.54 V	A	Off	Off	On
γ33	S8 = SIG.5	P1	P8	—	2.54 V	A	Off	Off	On
γ3K	S8 = SIG.5	P1	P8	—	2.54 V	A	Off	Off	On
γM1	S8 = SIG.5	P1	P8	4 V	2.32 V	A	On	Off	On
γM2	S8 = SIG.5	P1	P8	4 V	2.32 V	A	On	Off	On
γM3	S8 = SIG.5	P1	P8	4 V	2.32 V	A	On	Off	On
γMK	S8 = SIG.5	P1	P8	4 V	2.32 V	A	On	Off	On
γMC	S8 = SIG.5	P1	P8	4 V	2.32 V	A	On	On	On
γ2L	S8 = SIG.5	P1	P8	5 V	1.0 V	A	On	Off	On
γ2H	S8 = SIG.5	P1	P8	5 V	5 V	A	On	Off	On
γ2T	S8 = SIG.5	P1	P8	5 V	—	A	On	Off	On
γ2D	S8 = SIG.5	P1	P8	5 V	3.4 V	A	On	Off	On
γ2DC	No signal	P1	P8	5 V	—	B	On	Off	Off
γ1F	S8 = SIG.6	P1	P8	0 V	—	A	On	Off	Off
γ2F	S8 = SIG.6	P1	P8	5 V	—	A	On	Off	Off
γ3F	S8 = SIG.6	P1	P8	—	2.54 V	A	Off	Off	On

[1H Interpolation: Aperture Correction System]

Symbol	Input signal	Input pulse	Trimmer voltage		Switch							
			S7	VR4	VR1	SW10	SW11	SW12	SW14	SW15	SW16	SW13
LSPDO	No signal	P1	—	—	—	B	Off	—	B, A	—	—	—
LSPDC	No signal	P1	—	—	—	B	Off	—	B	—	—	—
LSPGD	S10 = SIG.5	P1	—	—	—	A	Off	—	B, A	—	—	—
LSPG	S10 = SIG.5	P1	—	—	—	A	Off	—	B	—	—	—
APCT	S10 = SIG.6	P1	0 V	Scan	—	A	A	A	B	Off	C	Off
APCH	S10 = SIG.6	P1	0 V	—	—	A	A	A	B	Off	A	Off
APH	S10 = SIG.6	P1	0 V	—	—	A	A	A	B	Off	B	Off
APDP	S10 = SIG.6	P1	Scan	APCT	—	A	A	A	B	A	C	Off
APDST	S10 = SIG.6	P1	0, 2.4 V	APCT	—	A	A	A	B	Off	C	Off
APDSL	S10 = SIG.6	P1	0, 2.4 V	APCT	—	A	A	A	B	B	C	Off
APDOSH	S10 = SIG.6	P1	0, 2.4 V	APCT	—	A	A	A	B	A	C	Off
APYG	S10 = SIG.5	P1	—	—	—	A	B	B	B	—	—	Off
APYD	S10 = SIG.5	P1	—	—	—	A	B	B	B	—	—	Off
APYDC	No signal	P1	—	—	—	B	B	B	B	—	—	Off
APYF	S10 = SIG.6	P1	—	—	—	A	B	B	B	—	—	Off

[Video Output System: Current Drain]

Symbol	Input signal	Input pulse					Trimmer voltage	Switch								
		S2	S5	S7	S9	S11		VR12	SW6, 7	SW10	SW11	SW12	SW14	SW13	SW17	SW18
VODC	S13 = SIG.5	—	—	P1	P9	P8	—	—	—	—	—	—	—	A	Off	Off
VOSY	S13 = SIG.5	—	—	P1	P9	P8	—	—	—	—	—	—	—	A	Off	Off
VOPT	S13 = SIG.5	—	—	P1	P9	P8	—	—	—	—	—	—	—	A	Off	Off
VOG	S13 = SIG.5	—	—	P1	P9	P8	—	—	—	—	—	—	—	A	Off	Off
VOLC	S13 = SIG.5	—	—	P1	P9	P8	—	—	—	—	—	—	—	A	Off	Off
VOWCT	S13 = SIG.5	—	—	P1	P9	P8	—	—	—	—	—	—	—	A	Off	Off
VOPL	S13 = SIG.5	—	—	P1	P9	P8	—	—	—	—	—	—	—	A	B	Off
VOPH	S13 = SIG.5	—	—	P1	P9	P8	—	—	—	—	—	—	—	A	A	Off
VOWCH	S13 = SIG.5	—	—	P1	P9	P8	—	—	—	—	—	—	—	A	Off	B
VOD	S13 = SIG.5	—	—	P1	P9	P8	—	—	—	—	—	—	—	A	Off	A
VOF	S13 = SIG.6	—	—	P1	P9	P8	—	—	—	—	—	—	—	A	Off	Off
VOL	S13 = SIG.5	—	—	P1	P9	P8	—	—	A	B	B	B	B	B	Off	Off
ICDS	No signal	P1	—	—	—	—	—	—	—	—	—	—	—	—	—	—
IVDO	No signal	P1	P1	P1	—	—	0 V	On	—	B	B	—	—	—	—	—
IDRI	No signal	—	—	—	—	—	—	—	—	—	—	—	—	—	—	—
VREF	No signal	P1	P1	P1	—	—	—	—	—	—	—	—	—	—	—	—

Pin Assignment and Equivalent Circuit Block Diagram

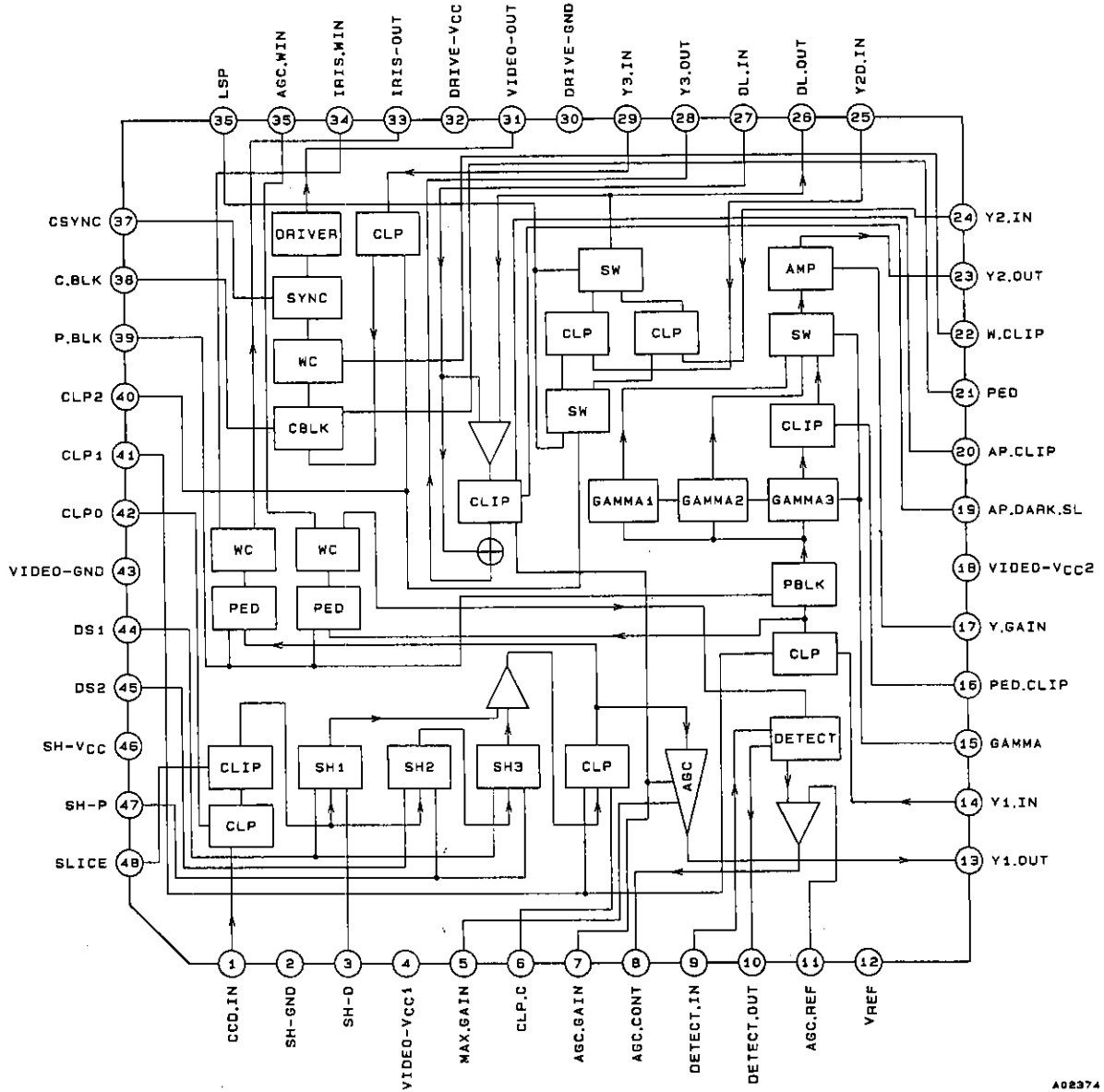

A08374

LA7265W

Pin Functions

Unit (resistance: Ω), I: input, O: output, B: I/O, P: power supply

Pin No.	Symbol	I/O	Equivalent circuit	Function
1	CCD. IN	I	<p style="text-align: center;">A02375</p>	<p>CCD signal input. This pin can handle CCD signal reset levels up to 0.5 Vp-p. The data level is sliced at a maximum saturation output of 1.5 V.</p>
2	SH-GND	P		<p>CDS system ground. This line should be kept as short as possible since the CDS system handles high frequencies.</p>
3	SH-D	I	<p style="text-align: center;">A02376</p>	<p>This pin controls the charge and discharge speeds of the SH1 circuit. Leave this pin open when a CCD element with 300,000 or fewer pixels is used. Set this pin to 5 V when a CCD element with over 300,000 pixels is used.</p>
4	VIDEO-V _{CC1}	P		<p>AGC amplifier system V_{CC}. Apply 5 V to this pin. Use pin 43 as the corresponding ground. Either decouple (we recommend using a power supply separate from the other V_{CC}s for this voltage) or use a DC-DC converter design so that signal component frequencies do not leak into this V_{CC}.</p>
5	MAX. GAIN	I	<p style="text-align: center;">A02377</p>	<p>AGC maximum gain control.</p> <p>The value of the maximum gain is: About 15.5 dB when pin 5 is at 0 V, About 24 dB when pin 5 is open, and About 31 dB when pin 5 is at 5 V.</p>
6	CLP. C	B	<p style="text-align: center;">A02378</p>	<p>Charge/discharge capacitor used for post-CDS OPB clamping. We recommend a value of 0.1 μF for this capacitor.</p>

Continued on next page.

LA7265W

Continued from preceding page.

Unit (resistance: Ω), I: input, O: output, B: I/O, P: power supply

Pin No.	Symbol	I/O	Equivalent circuit	Function
7	AGC. GAIN	I		<p>AGC control signal input. The signal that was clamped by the post-CDS OPB is split into two paths. The first path goes to the AGC amplifier system. This pin is provided to adjust the AGC gain according to the brightness, and it uses the smoothed AGC control voltage output from pin 8. The AGC minimum gain is about -2 dB. See the description of pin 39 for the second path from this pin.</p>
8	AGC. CONT	O		<p>AGC control signal output. This output is smoothed by an RC circuit and then input to pin 7. The range over which the AGC control voltage varies is about 1 to 3 V.</p>
9	DETECT. IN	I		<p>AGC detector circuit input. The pin 10 output is resistor divided, smoothed and input to this pin.</p>
10	DETECT. OUT	O		<p>AGC detector circuit output. A signal that has had pedestal added and has been white clipped (see the pin 35 description) is amplified by the AGC detector amplifier and output from this pin. An emitter open circuit is used for this output. This output must be resistor divided and smoothed by a capacitor.</p>
11	AGC. REF	I		<p>AGC control amplifier reference input. The voltage input to pin 9 goes to the AGC control amplifier. The state of this pin adjusts the AGC control voltage. (This pin is normally left open.) If the image is too bright, lower the AGC amplifier gain sensitivity by lowering this pin (AGC.REF) to lower the AGC control voltage. If the image is too dark, increase the AGC amplifier gain sensitivity by raising this pin (AGC.REF) to increase the AGC control voltage.</p>

Continued on next page.

LA7265W

Continued from preceding page.

Unit (resistance: Ω), I: input, O: output, B: I/O, P: power supply

Pin No.	Symbol	I/O	Equivalent circuit	Function
16	PED. CLIP	I		S-curve gamma control. This pin is normally left open when the variable γ circuit is used. However, S-curve γ correction can be enabled by clipping near the pedestal level by applying 5 V to this pin.
17	Y. GAIN	I		<p>Y signal gain control. The signal that has passed through one of the γ correction circuits goes to the Y gain control amplifier. This pin adjusts the amount of amplification, which determines the amplitude of the final output. This pin is normally left open when the $\gamma = 0.45$ or the $\gamma = 1$ circuits are used. Gamma correction is applied when the data level of the input CCD signal is under 500 mV, and the knee characteristics apply when that level is over 500 mV. Set up pin 15 as follows to set the Y gain control output level for a 500 mV input signal to be identical for all three gamma correction circuits.</p> <p>When pin 15 is open ($\gamma = 0.6$):Pin 17 = 2.54 V When pin 15 = 4 V ($\gamma = \text{max}$):Pin 17 = 2.32 V</p>
18	VIDEO- V_{CC2}	P		Video system V_{CC} . This V_{CC} is used as the V_{CC} for all systems except the CDS system, the AGC amplifier system and the 75 Ω driver system. Apply 5 V and insert a 0.1 μF capacitor between this pin and ground.
19	AP. DARK. SL	I		<p>Aperture dark slope control. The aperture clipping level varies with the AGC control voltage (pin 7). The clipping level is fixed for relatively bright situations, i.e., when pin 7 is under 2 V. However, as the image begins to get darker (i.e., as the pin 7 voltage moves from about 2 V to the aperture dark point) the clipping level begins to increase. When the AGC control voltage exceeds the aperture dark point, the aperture is suppressed for low illumination and the clipping level increases along with the AGC control voltage. It is this pin that controls the coefficient for that increase.</p> <p>Pin 19 = 0 V:Minimum coefficient value Pin 19 = open:Typical coefficient value Pin 19 = 5 V:Maximum coefficient value</p>
20	AP. CLIP	I		Aperture clipping control. The LA7265W clips the aperture whisker components at the base. This pin adjusts the clipping level. Adjust this pin if the IC internal slice level is inappropriate.

Continued on next page.

LA7265W

Continued from preceding page.

Unit (resistance: Ω), I: input, O: output, B: I/O, P: power supply

Pin No.	Symbol	I/O	Equivalent circuit	Function
21	PED	I		<p>Setup control. The setup level can be controlled by using this pin to control the level of the pedestal that is added with the timing of the blanking pulse input to pin 38.</p> <p>Pin 21 = 0 V: Setup level = -120 mV Pin 21 = open: Setup level = 95 mV Pin 21 = 5 V: Setup level = 240 mV</p>
22	W. CLIP	I		<p>Saturation level control. The LA7265W white clips the signal to which pedestal has been added at pin 21. This pin adjusts the white clipping level.</p> <p>Pin 22 = 0 V: Clipping at about 0.9 V Pin 22 = open: Clipping at about 1.5 V Pin 22 = 5 V: Clipping at about 2.0 V</p>
23	Y2. OUT	O		<p>Outputs the signal that has passed through the Y gain control. (See the description of pin 17.) Normally, this output is input to pin 24 (25) through a coupling capacitor. However, it is input to pin 29 through a coupling capacitor when aperture correction is not used.</p>
24	Y2. IN	I		<p>Original signal input. Input the y corrected signal through a coupling capacitor. OPB clamping is applied at the input stage, clamping at about 1.8 V. The clamping pulse signal is input to pin 40.</p>
25	Y2D. IN	I		<p>Input for the 1H delayed signal used for interpolation. When a low resolution CCD device (e.g., about 60,000 pixels) is used and 1H interpolation is desired, use a 1H delay line and input the 1H delayed signal through a coupling capacitor. OPB clamping is applied at the input stage, clamping at about 1.8 V. Leave this pin open when 1H interpolation is not required. Input the clamping pulse signal to pin 40.</p>

Continued on next page.

LA7265W

Continued from preceding page.

Unit (resistance: Ω), I: Input, O: output, B: I/O, P: power supply

Pin No.	Symbol	I/O	Equivalent circuit	Function
26	DL. OUT	B		Output to the delay line and input for the delay line reflected signal. Outputs the signal that has passed through 1H interpolation. Aperture correction is performed by inserting an aperture correction delay line (with an impedance of about 1 k Ω) at this output. Since a 1 k Ω resistor is built in to this pin's internal circuit, the DL reflected signal is created at about 1/2 the level of the original signal. This signal is combined with the original signal and the combination is input to the aperture correction circuit.
27	DL. IN	I		Delay line delayed signal input. This pin inputs the signal that has passed through the aperture correction delay line to the aperture correction circuit. The combined signal consisting of the original signal and the reflected signal is subtracted from the delay line signal (pin 27), and the aperture whisker components are created by amplifying that difference signal. See the description of pins 19 and 20 for details on whisker component control.
28	Y3. OUT	O		The aperture clipped whisker components are added to the original signal at a fixed ratio and output from this pin. The original signal gain is about 0 dB.
29	Y3. IN	I		The aperture corrected signal is input to this pin through a coupling capacitor. OPB clamping is applied at the input stage, clamping at about 1.8 V with the timing of the clamp pulse signal input to pin 40.
30	DRIVE-GND	P		Ground for the 75 Ω driver system.
31	VIDEO-OUT	O		Video signal output. A signal that has sync added at pin 37 and has been amplified is output through the driver circuit. When output is to a unit that has a 75 Ω load, the 140 IRE = about 1.9 V output signal can be converted to a 140 IRE = about 1.0 V signal by inserting a 68 Ω resistor.

Continued on next page.

LA7265W

Continued from preceding page.

Unit (resistance: Ω), I: input, O: output, B: I/O, P: power supply

Pin No.	Symbol	I/O	Equivalent circuit	Function
32	DRIVE- V_{CC}	P		75 Ω driver system V_{CC} . Since the current variations in this system are large, care must be taken to prevent this system from influencing other power supplies. Apply a 5 V potential and insert a capacitor of about 0.1 μ F between this pin and ground.
33	IRIS-OUT	O	<p style="text-align: right;">A02380</p>	Iris control signal output. The signal that had pedestal added and was white clipped is amplified by about 10 dB by the iris amplifier and output from this pin.
34	IRIS. WIN	I	<p style="text-align: right;">A02397</p>	Iris window pulse input. White clipping is applied to the signal that had pedestal added (see the pin 39 description). The clipping level changes depending on this pin's input state. (0 V \rightarrow maximum, open \rightarrow typical, 5 V \rightarrow minimum clipping levels) Iris windowing is possible by inputting an iris window pulse signal that has three values: 0 V, floating, and 5 V.
35	AGC. WIN	I	<p style="text-align: right;">A02397</p>	AGC window pulse input. The other signal that had OPB clamping applied at pin 14 goes to the AGC detector system. First a pedestal on the order of a few tens of mV is added using the blanking pulse input from pin 39. Next, white clipping is applied. However, the clipping level changes according to the state of this pin. (0 V \rightarrow maximum, open \rightarrow typical, 5 V \rightarrow minimum clipping levels) AGC backlighting correction is possible by inputting an AGC window pulse signal that has three values: 0 V, floating, and 5 V.
36	LSP	I	<p style="text-align: right;">A02398</p>	1H interpolation control pulse input. When 1H interpolation is used, input an LSP pulse () that switches on each 1H to this pin. Pin 40 clamp pulse switching is performed by the LSP pulse. This circuit also switches the OPB clamped original signal and the 1H delayed signal. When 1H interpolation is not used, only the original signal is OPB clamped and passed through this circuit.

Continued on next page.

LA7265W

Continued from preceding page.

Unit (resistance: Ω), I: input, O: output, B: I/O, P: power supply

Pin No.	Symbol	I/O	Equivalent circuit	Function
37	C. CYNC	I		<p>Composite synchronization signal pulse input. Sync is added to the signal white clipped at pin 22 with the timing of the composite synchronization pulse (\square) signal input to this pin. Also, the signal including synchronization is amplified by about 7.7 dB. When the pin 29 input signal level is set to 500 mV (white average), the signal level, including setup and sync, is amplified to be 140 IRE = about 1.9 V when pin 31 is unloaded. Therefore the pin 31 output will be:</p> <p>White average: = about 1220 mV Saturation level: = about 1700 mV (when the pin 29 input saturation level is about 700 mV) Sync level: = about 550 mV</p>
38	C. BLK	I		<p>Composite blanking pulse input. The signal OPB clamped at pin 24 is blanked with the timing of the composite blanking pulse (\square) input to this pin. Also, pedestal of the prescribed level is added with the same timing and setup is also inserted. At that time, levels 250 mV or more lower than the OPB level are low clipped.</p>
39	P. BLK	I		<p>Pre-blanking pulse input. The other path for the signal that was clipped by the post-CDS OPB goes to the Iris amplifier system. First, pedestal is added using the pre-blanking pulse (\square) input to this pin. In addition, this signal is also used by the AGC detector system and the γ correction system.</p>
40	CLP2	I		<p>Input for the output clamping pulse. This pin inputs the clamping pulse (\square) for OPB clamping used by pins 24, 25 and 29. The clamping pulse timing is delayed with respect to CLP1 to take into account the amount the signal is delayed within the IC and by the external LPF. When 1H interpolation is used, the clamping pulse is turned on or off every 1H with the timing of the LSP pulse. This is then used as the OPB clamp for pins 24 and 25.</p>
41	CLP1	I		<p>OPB clamp pulse input. The dark current variations every 1H are taken up by clamping, with the OPB timing, the signal that became a continuous wave signal in the CDS system. This pin is the clamp pulse (\square) input for that operation, and normally can be shared with pin 42.</p>

Continued on next page.

LA7265W

Continued from preceding page.

Unit (resistance: Ω), I: Input, O: output, B: I/O, P: power supply

Pin No.	Symbol	I/O	Equivalent circuit	Function
42	CLP0	I		<p>CCD signal clamp pulse input. The CCD signal input to pin 1 is clamped to the prescribed voltage with the OPB timing. This pin inputs that clamp pulse (), and normally can be shared with pin 41.</p>
43	VIDEO-GND	P		Ground for the video system.
44	DS1	I		<p>Data timing sampling pulse input. This signal is divided into two paths to perform CDS (correlation dual sampling) on the sliced CCD signal. In the first path, the data level is sampled and held (SH1) with the data timing. This pin is the sampling pulse () input pin for that function.</p>
45	DS2	I		<p>Pre-charge timing sampling pulse input. In the second sliced CCD signal path, the precharge level is sampled and held (SH2) with the precharge timing. This pin is the sampling pulse () input pin for that function. Next, this sampled and held signal is once again sampled and held (SH3), here, by DS1 (the data timing sampling pulse). Finally, the reset noise for each pixel is taken up by subtracting these two sampled and held signals by a mixing amplifier.</p>
46	SH-V _{CC}	P		CDS system V _{CC} . Apply 5 V and insert a 0.1 μF capacitor between this pin and ground.
47	SH-P	I		<p>This pin controls the charge/discharge speed of the SH2 and SH3 circuits. Pin usage is identical to that for pin 3.</p>
48	SLICE	I		<p>CCD signal level control. Slices the saturation level of the CCD signal that was OPB clamped. The possible slice levels are as follows: Pin 48 = 0 V:about 1.5 V Pin 48 = open:about 1.1 V Pin 48 = 5 V:about 0.5 V</p>

Continued on next page.

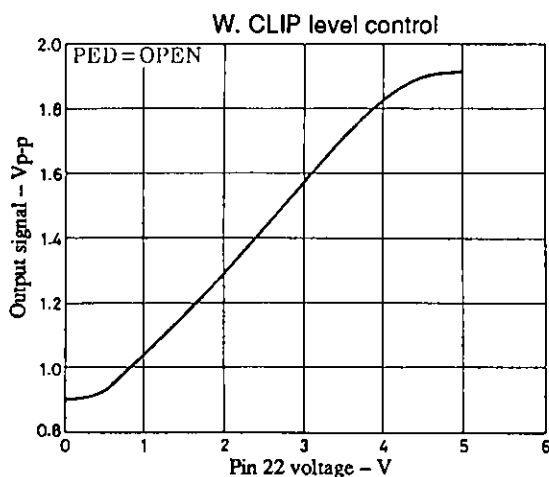
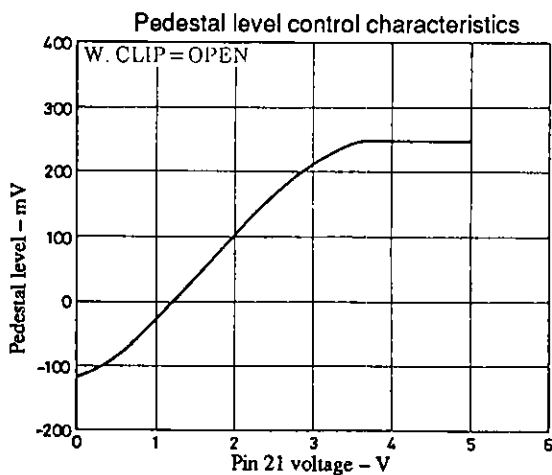
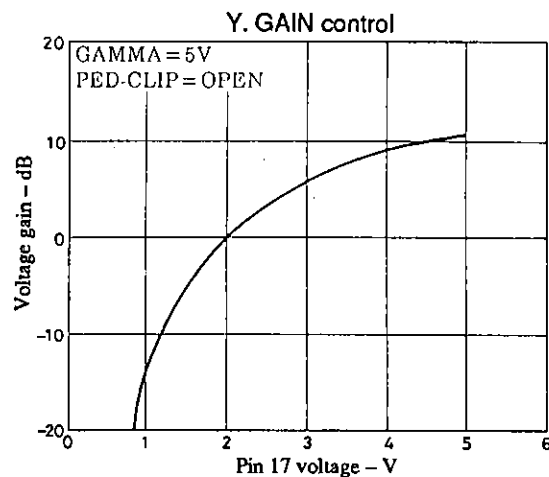
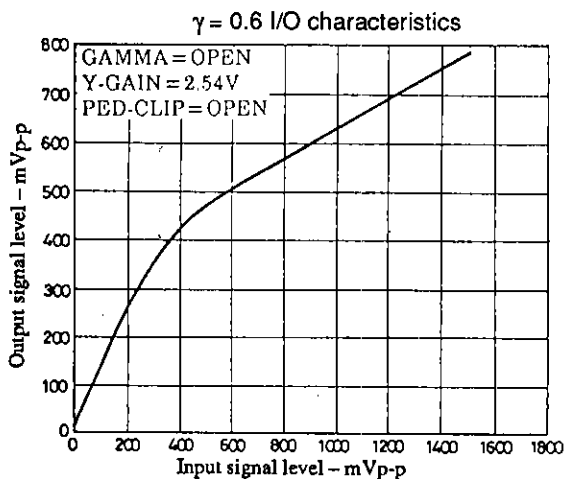
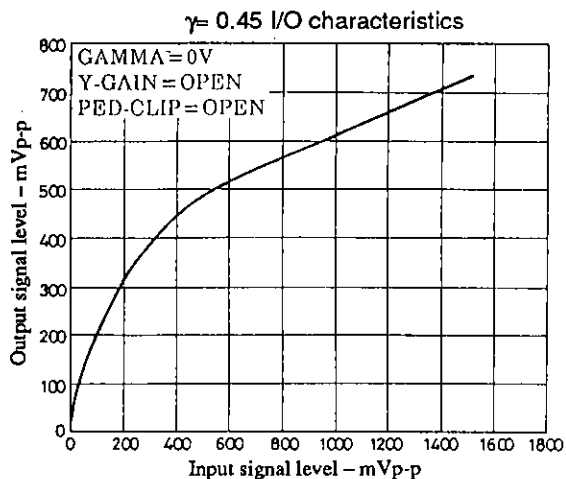
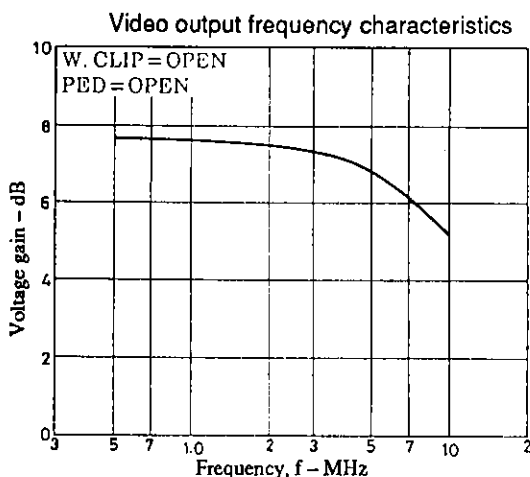
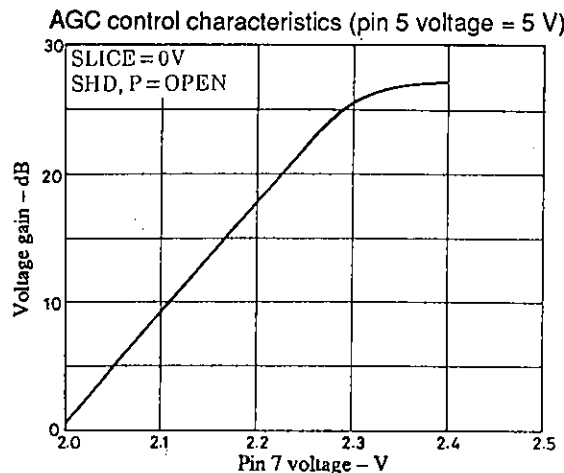
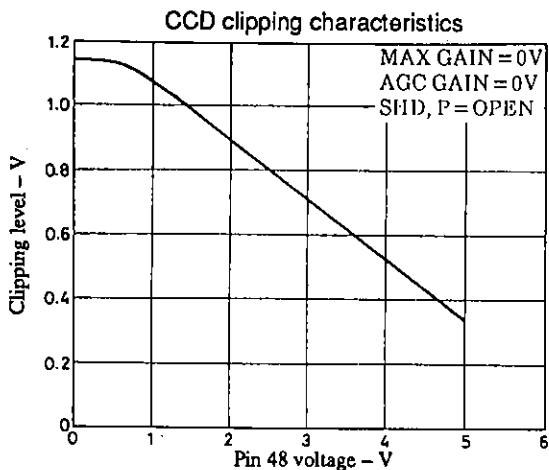

LA7265W

Test Circuit

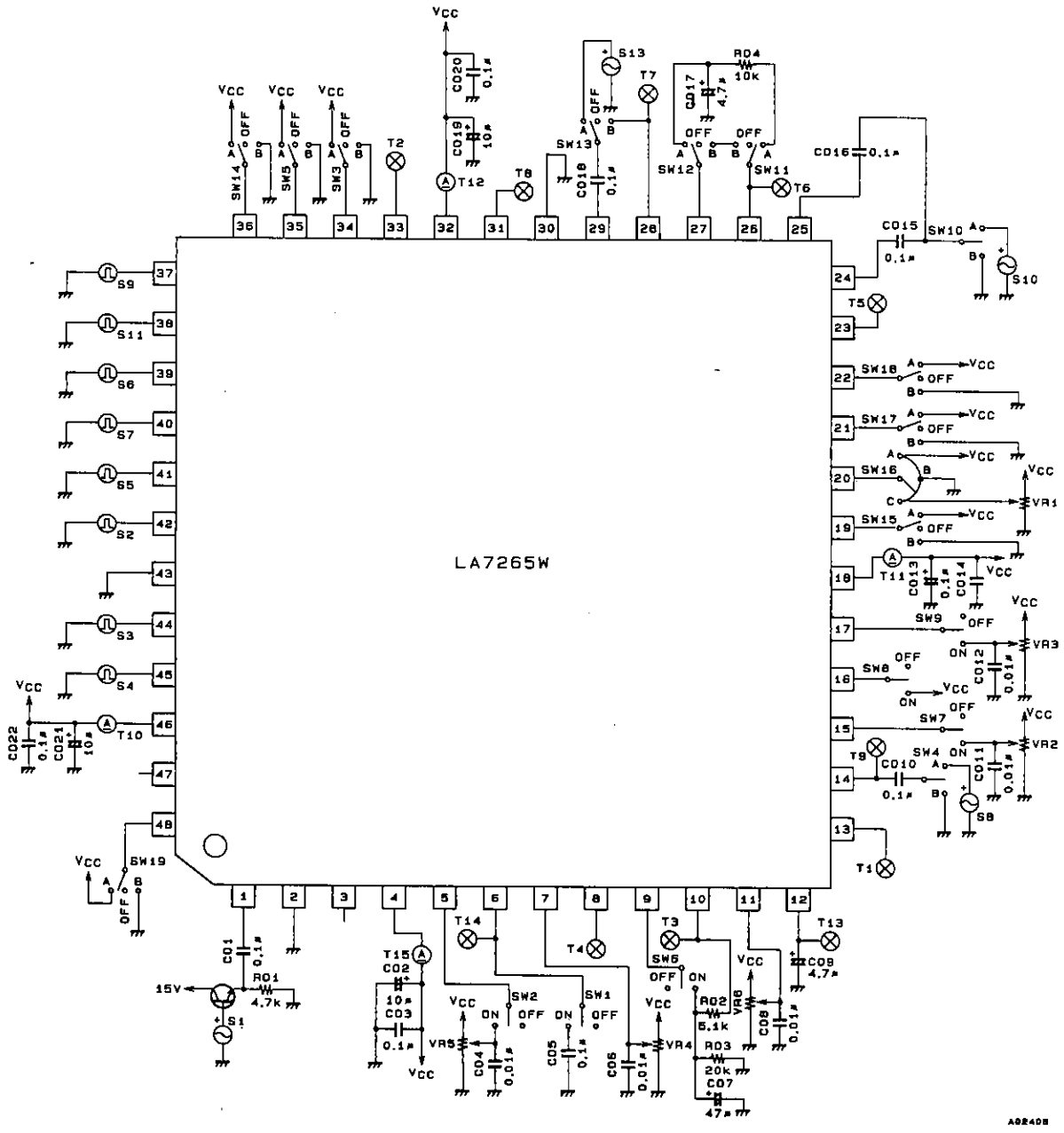

Unit (resistance: Ω, capacitance: F)

Test Signals

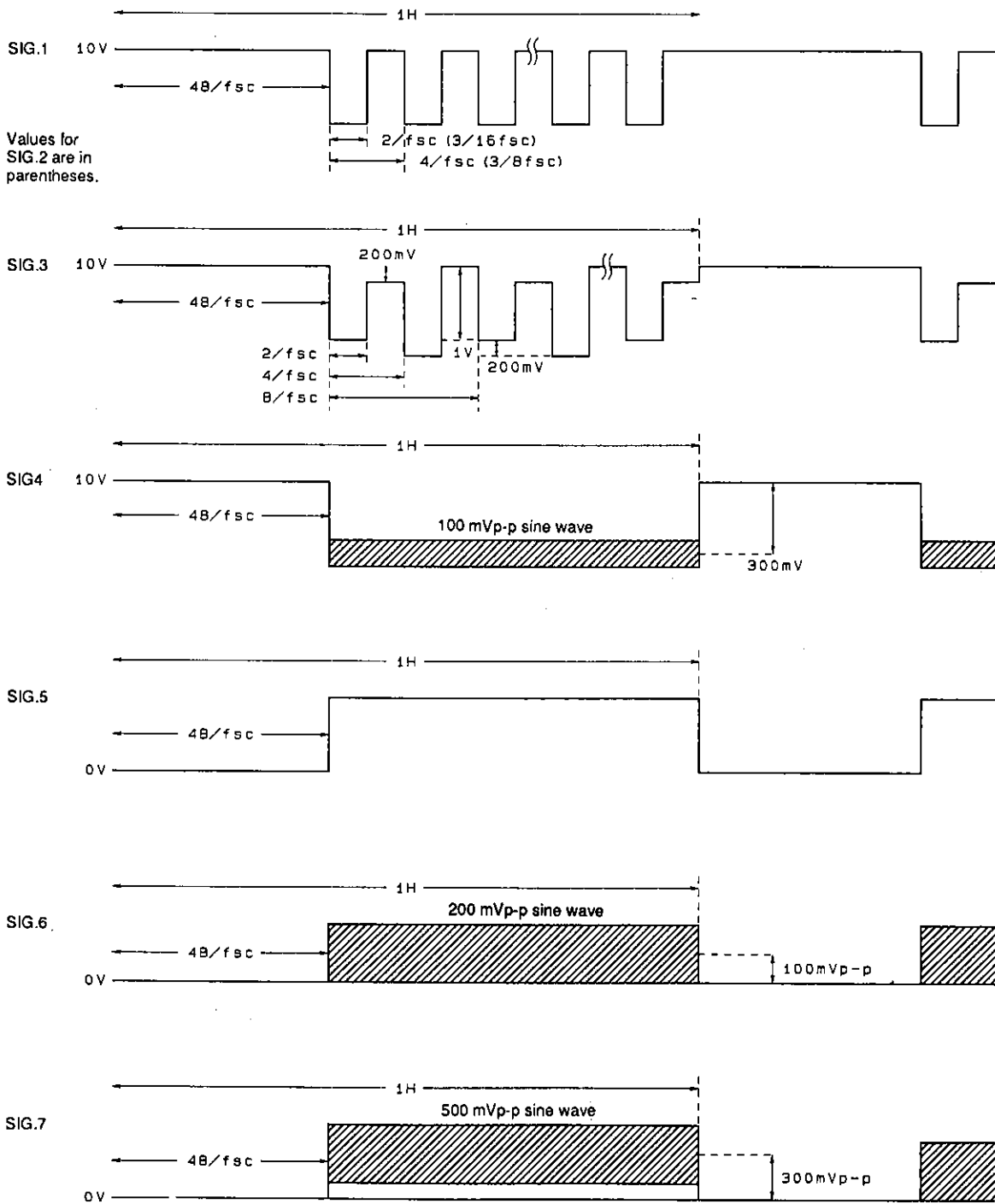

A02406

Test Input Pulse Signals

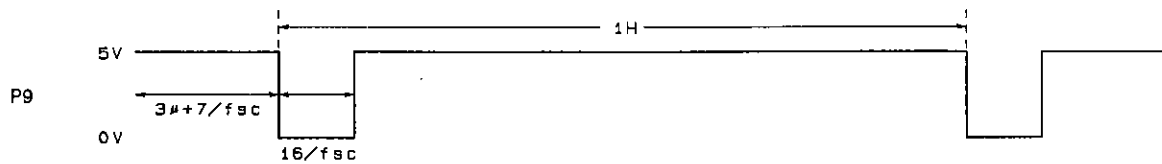
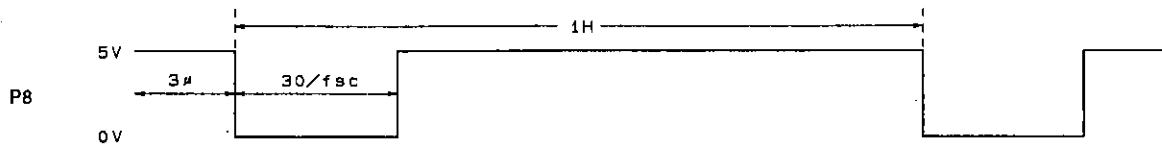
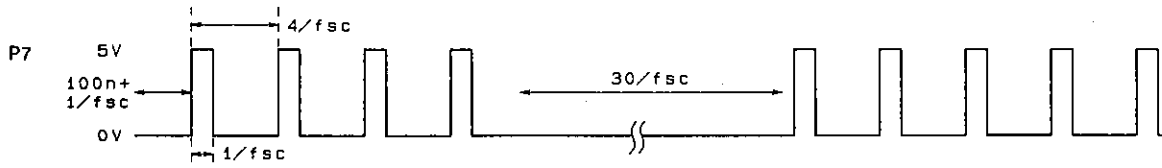
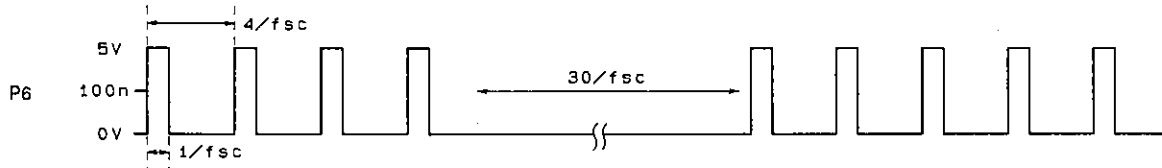
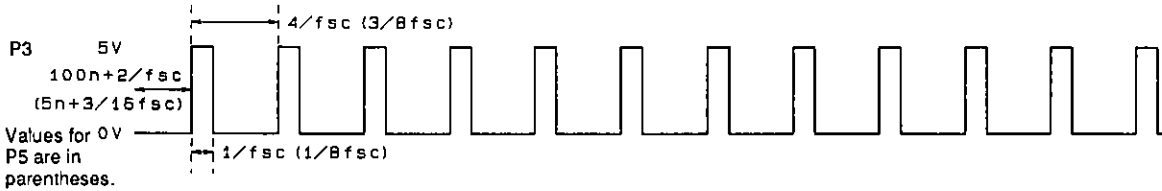
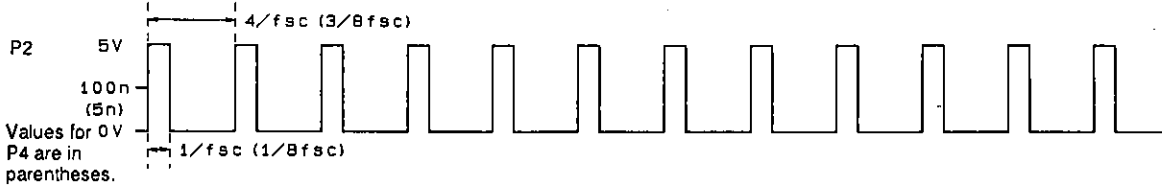
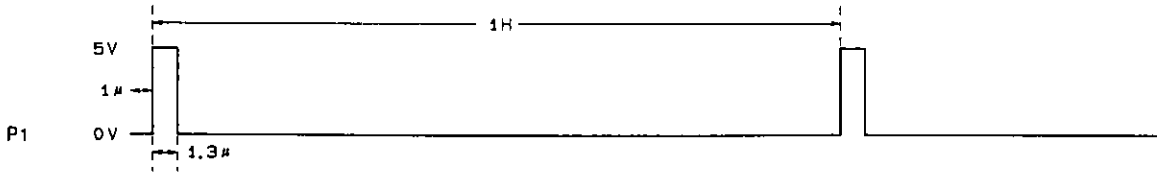

A02407

