

Overview

The LA5601 is a voltage regulator with a low-voltage detector and reset controller for use in microprocessor-based systems. It generates a reset signal for low power supply voltage. It also features a low 0.25V (typ.) dropout voltage for reduced power dissipation and power supply size. Applications include microprocessor-controlled consumer electronic equipment such as CD players, tuners and receivers, and preamplifiers.

Functions

- Low dropout regulator with 250mA and 5.2V output
- Power supply reset generator function
- Supports on-off control of 5.2V using equipped enable pin (high active)
- Built-in Darlington driver (120mA)
- Built-in auxiliary regulator (5.2V, 250mA)

Features

- Low minimum input-output voltage difference (0.3V typ.)
- Supports setting of reset output delay time using external capacitor
- Built-in fold-back current limiting circuit and excessive heat protection circuit.
- Reset output using active pull-up for simpler noise reduction and use with internal pull-down logic circuits
- Error amplifier noise filter pin
- Auxiliary regulator with reverse current protection

Specifications

Maximum Ratings at $T_a = 25^\circ\text{C}$

			unit
Input Voltage	V_{IN} max	15	V
Enable Pin Voltage	V_{EN} max	V_{IN} max	V
Reset Output Pin Voltage	V_{RES} max	15	V
Driver Output Voltage	V_{OD} max	15	V
Driver Input Voltage	V_{ID} max	15	V
Allowable Power Dissipation	P_d max	1	W
Operating Temperature	T_{opr}	-30 to +80	$^\circ\text{C}$
Storage Temperature	T_{stg}	-55 to +150	$^\circ\text{C}$

Package Dimensions

unit:mm

3098-DIP10S

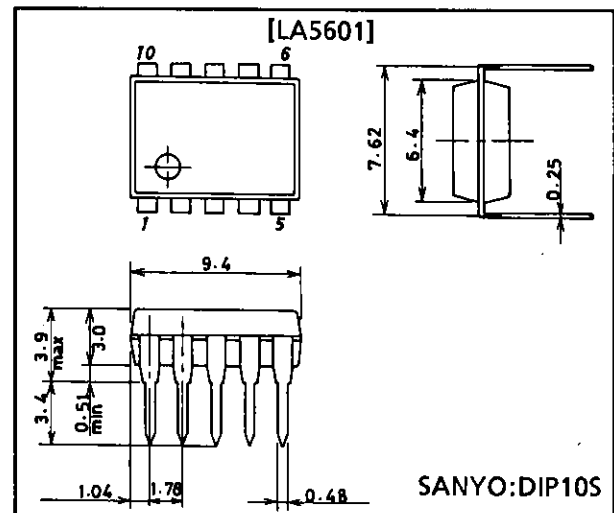

LA5601

Operating Conditions at Ta = 25°C

			unit
Input Voltage	V _{IN}	5.9 to 14	V
Output Current	I _{OUT}	0 to 250	mA
'H'-Level Reset Output Current	I _{ORH}	0 to 200	μA
'L'-Level Reset Output Current	I _{ORL}	0 to 2	mA
Auxiliary Regulator Output Current	I _{OA}	0 to 10	mA
Driver Output Voltage	V _{OD max}	14	V
'L'-Level Driver Output Current	I _{ODL max}	120	mA
'H'-Level Driver Input Voltage	V _{IDH}	I _{ODL} = 120mA	3 to 14 V
'L'-Level Driver Input Voltage	V _{IDL}	I _{ODL} ≤ 100μA	-0.3 to +0.3 V

Operating Characteristics at Tj = 25°C, V_{IN} = 6V, I_{OUT} = 200mA, See specified Test Circuit.

			min	typ	max	unit
[Main regulator : Output ON-state, V _{EN} = 'H' or open]						
Output Voltage	V _O		5.0	5.2	5.4	V
Dropout Voltage	V _{DROP}	I _{OUT} = 250mA		0.25	0.5	V
Line Regulation	ΔV _{OLN1}	5.5V ≤ V _{IN} ≤ 14V		30	80	mV
	ΔV _{OLN2}	6V ≤ V _{IN} ≤ 14V		20	40	mV
Load Regulation	ΔV _{OLD1}	5mA ≤ I _{OUT} ≤ 250mA		40	100	mV
	ΔV _{OLD2}	5mA ≤ I _{OUT} ≤ 100mA		14	50	mV
Peak Output Current	I _{OP}		250	500		mA
Output Short Current	I _{OSC}			80	300	mA
Current Drain	I _{Q1}	I _{OUT} = 0		2.2	6	mA
	I _{Q2}			10	30	mA
Output Noise Voltage	V _{NO}	10Hz ≤ f ≤ 100kHz		70		μVrms
Temperature Coefficient of Output Voltage	ΔV _O /ΔT _j	T _j = 25 to 80°C		-0.7		mV/°C
Ripple Rejection	R _{rej}	f = 120Hz, 7V ≤ V _{IN} ≤ 13V		74		dB
Output ON-State Control Voltage	V _{ENH}	Main regulator, driver ON	2.6		V _{IN}	V
[Main regulator : Output OFF-state, V _{EN} = 'L']						
'L'-Level Output Voltage	V _{O OFF}	V _{EN} = 0		50	200	mV
Quiescent Current	I _{Q OFF}	V _{EN} = 0		1.5	4	mA
Output OFF-State Control Voltage	V _{ENL}	Main regulator, driver OFF			1.0	V
[Reset circuit]						
'H'-Level Reset Output Voltage	V _{ORH}	I _{ORH} = 200μA	4.97	5.17	5.37	V
'L'-Level Reset Output Voltage	V _{ORL}	I _{ORL} = 2mA, V _{IN} = 3.7V		90	200	mV
Reset Threshold Voltage	V _{RT}	I _{OUT} = 5mA	3.7	3.9	4.1	V
Reset Hysteresis Voltage	V _{hys}	I _{OUT} = 5mA	50	150	300	mV
Reset Output Delay Time	t _d	C _d = 0.1μF	7.5	10	12.5	mS
[Auxiliary regulator]						
Output Voltage	V _{OA}	I _{OA} = 5mA	3.2	3.4	3.6	V
Line Regulation	ΔV _{OA LN}	6V ≤ V _{IN} ≤ 14V, I _{OA} = 5mA		15	40	mV
Load Regulation	ΔV _{OA LD}	2mA ≤ I _{OA} ≤ 10mA		130	200	mV
Output Short Current	I _{OA SC}		10	30		mA
Output Pin Leakage Current	I _{OA LEAK}	V _{IN} = 0, V _{OA} = 6V			2	μA
[Darlington driver]						
'L'-Level Driver Output Voltage	V _{ODL1}	I _{ODL} = 80mA, V _{ID} = 3V		1.1	1.6	V
	V _{ODL2}	I _{ODL} = 120mA, V _{ID} = 3V		1.2	1.8	V
'H'-Level Driver Input Current	I _{IDH}	I _{ODL} = 120mA, V _{ID} = 3V		0.4	1	mA
Output Pin Leakage Current	I _{ODH}	V _{IH} = 14V, V _{OD} = 14V, V _{ID} = 0.3V			50	μA

LA5601

Pin Assignment

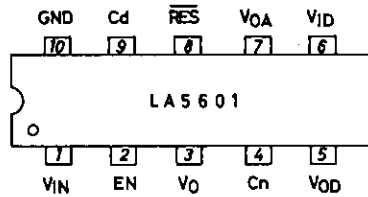

Top view

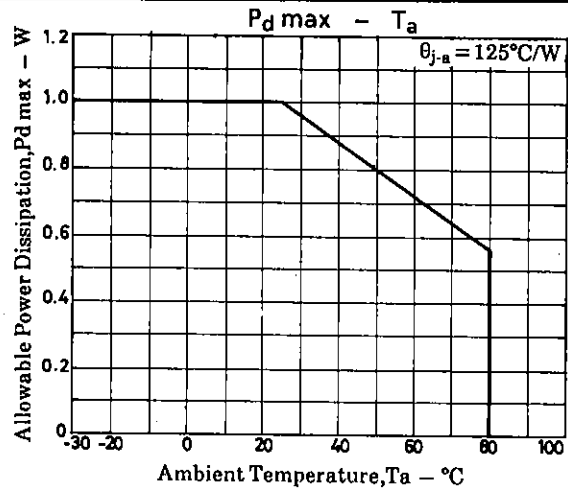

Equivalent Circuit Block Diagram

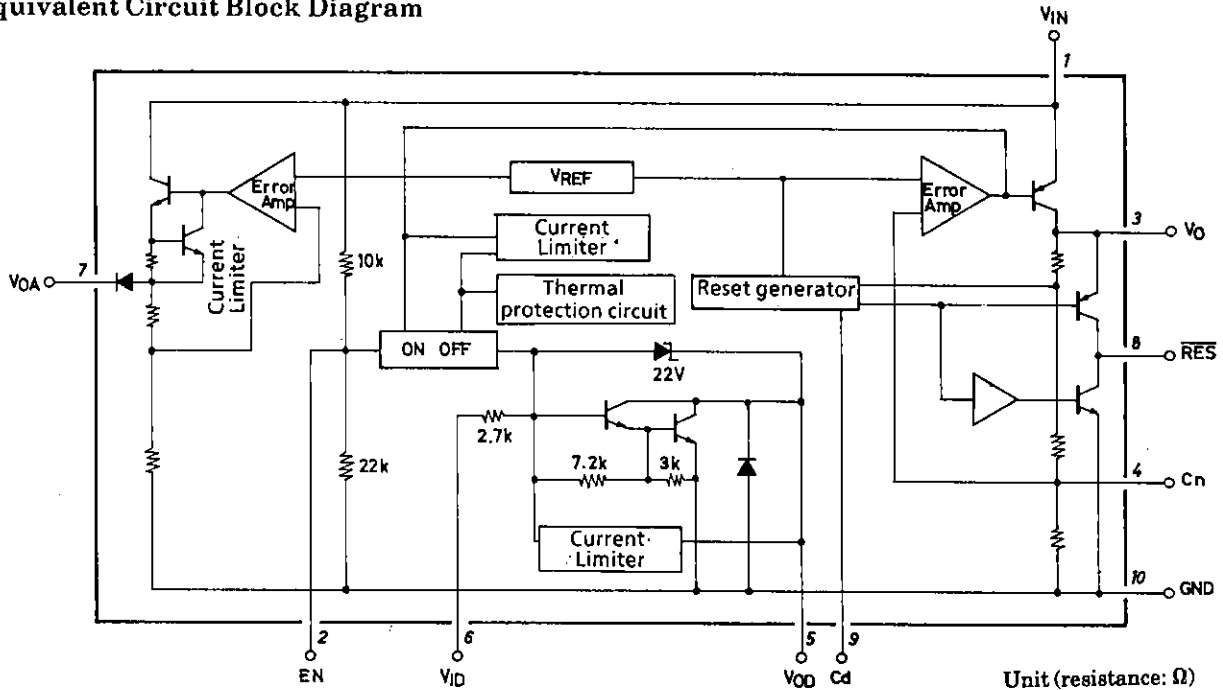

Specified Test Circuit

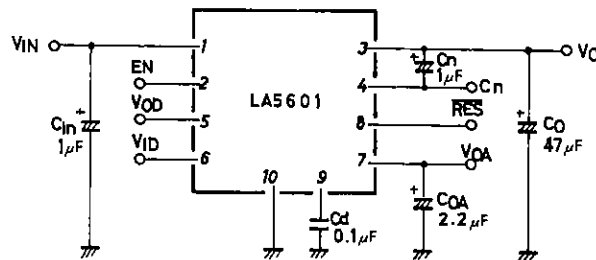

Sample Application Circuit 1

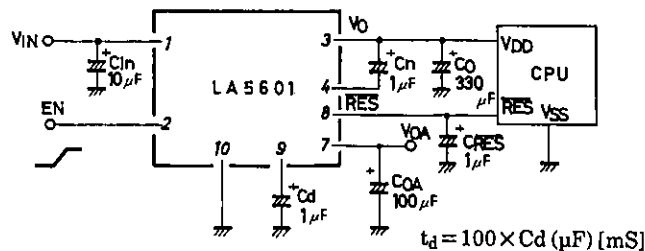

- Note) 1. Capacitors C_n and C_{RES} are only required if problems are experienced with noise from external sources.
2. If capacitor C_n is present, ensure that C_o is at least more than one-third of the value of C_{in} in order to prevent output noise at power-down due to capacitor discharge timing.
3. The minimum recommended value of output capacitor C_o is $47\mu F$.
4. Use a low temperature coefficient capacitor for the delay time capacitor C_d .

Function Table

V _{EN}	V _O	Driver
L	L	OFF
H	H	ON

V_{EN}='H' or open.

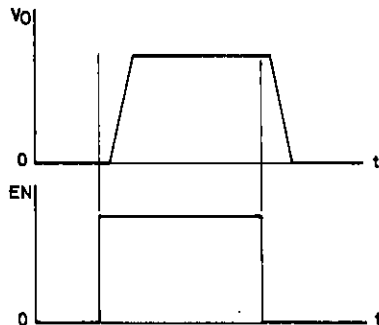

Enable Circuit

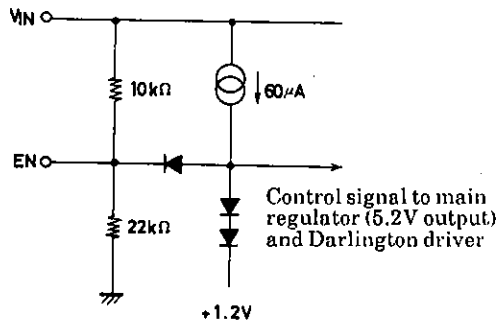

Reset Operation

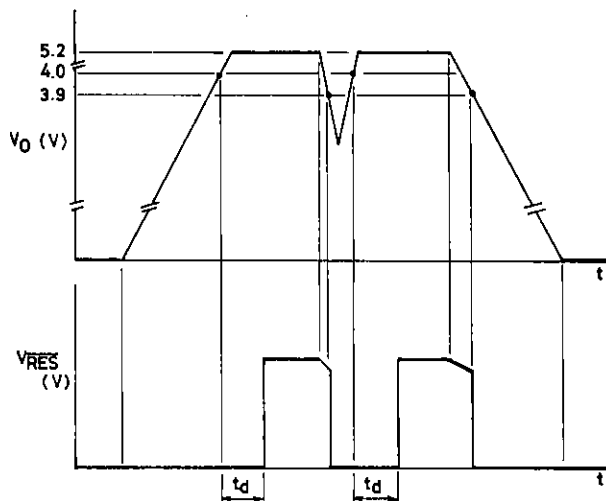

Sample Application Circuit 2
(Delay start regulator)

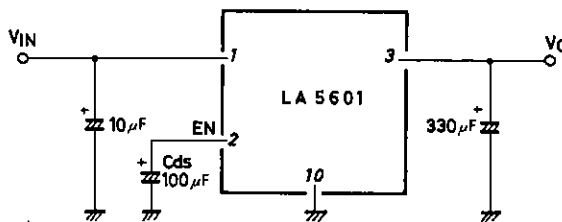

Sample Application Circuit 3
(Positive-to-negative DC converter)

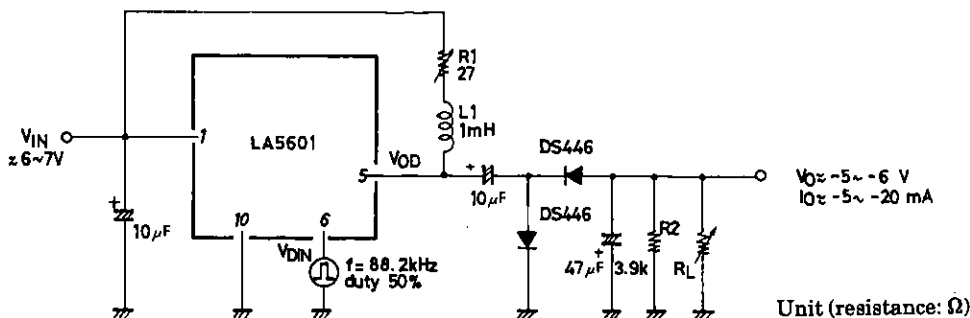

- Note 1. The output voltage can be fine-trimmed by adjusting R1. To protect the output transistor against over voltage, ensure that either R1 is non zero or use a low-Q coil for L1.
- Note 2. A load must always be present on power-up. To safeguard against excessive output voltages that occur when the circuit is powered up without a load, a dummy load resistor is recommended. This is shown on the circuit as R2.
- Note 3. Select V_{IN}, R1 and L1 so that V_{OD} < 14V, and I_{ODL} < 120mA. The component values shown require that V_{IN} never exceeds 9V.

LA5601

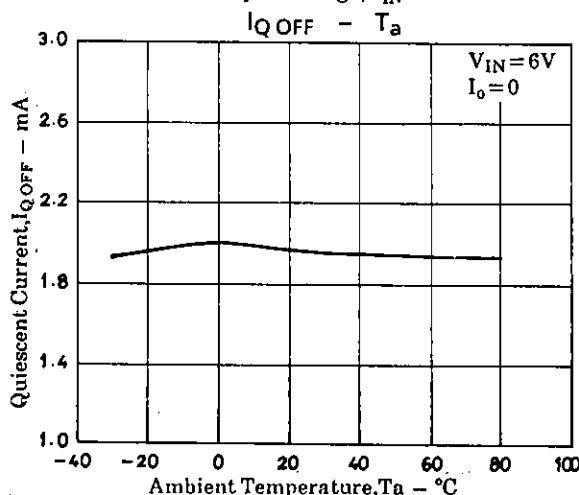
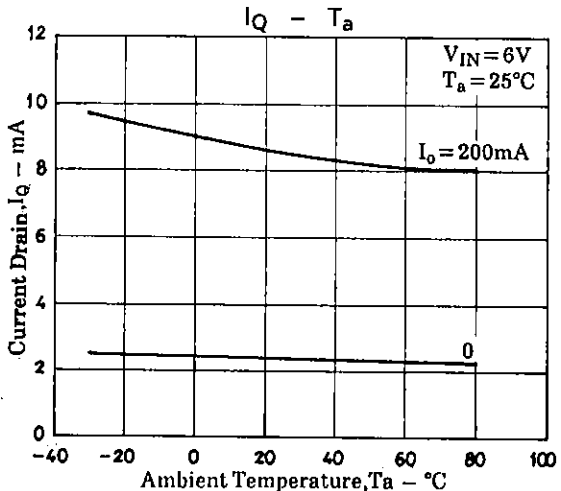
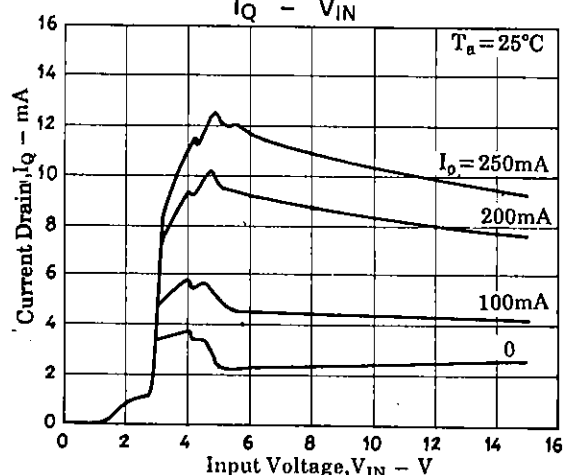
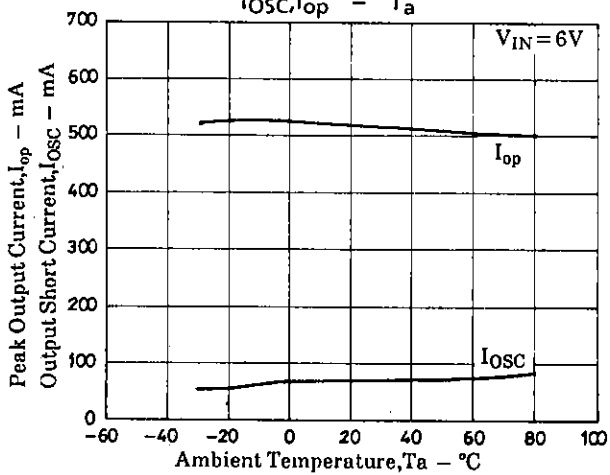
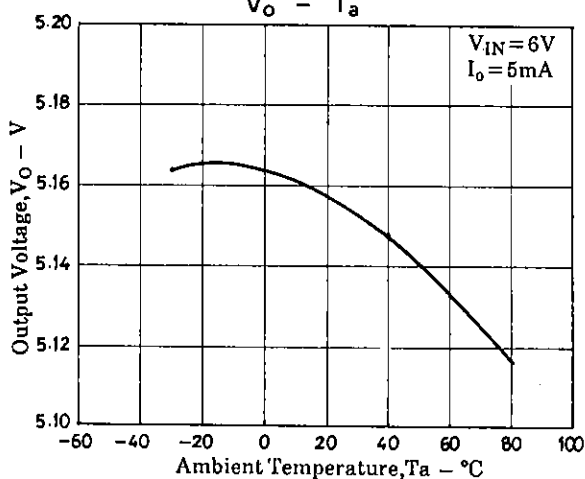
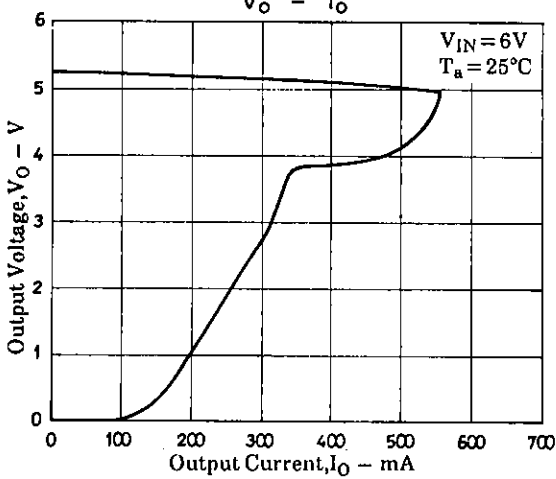
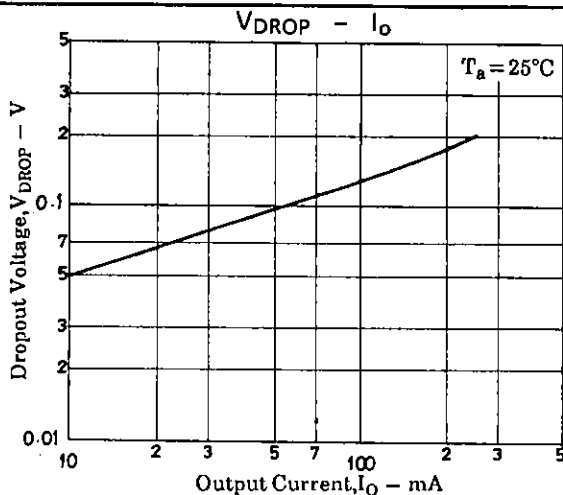
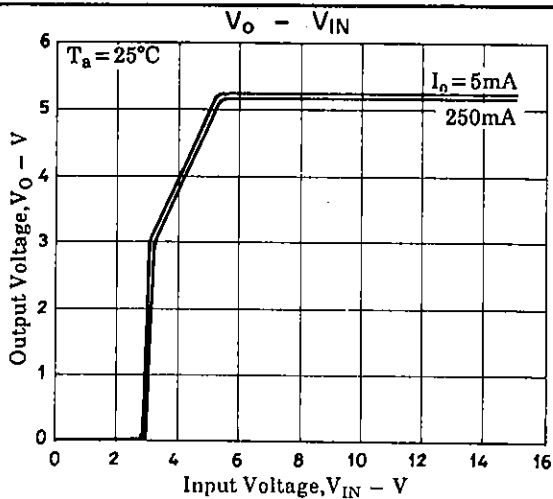

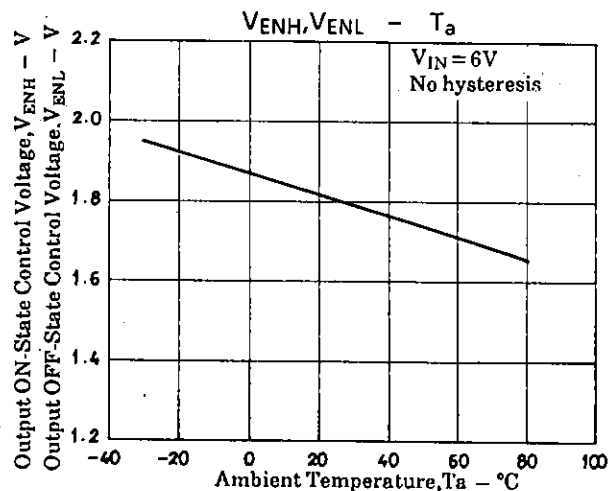
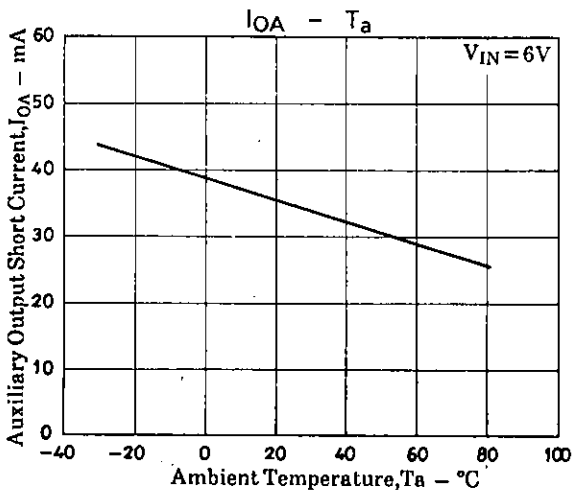
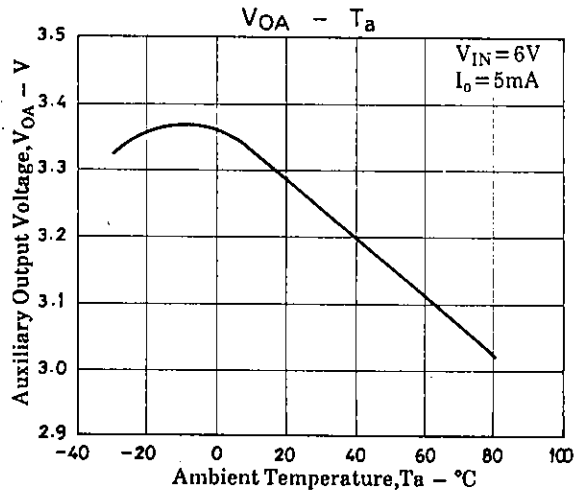
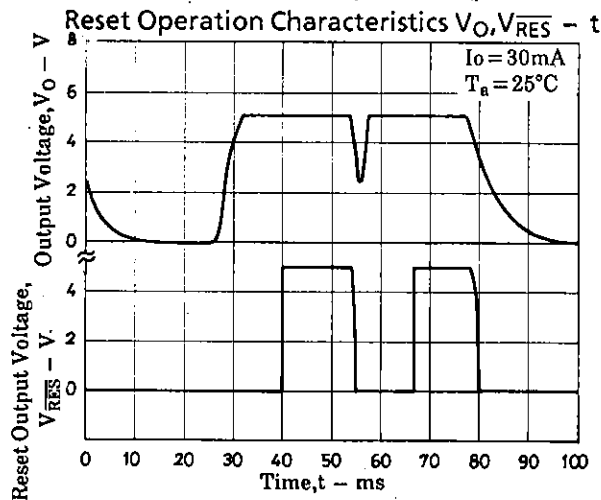
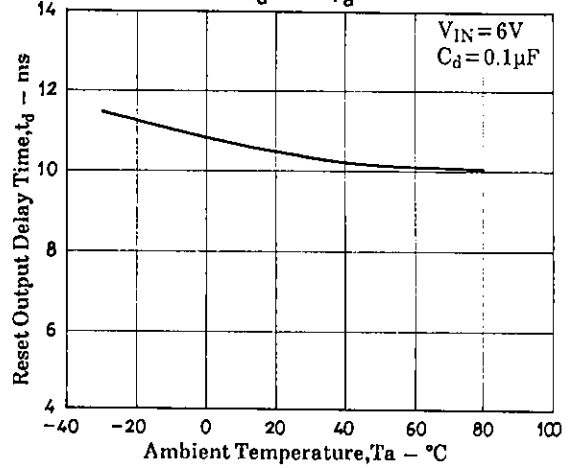
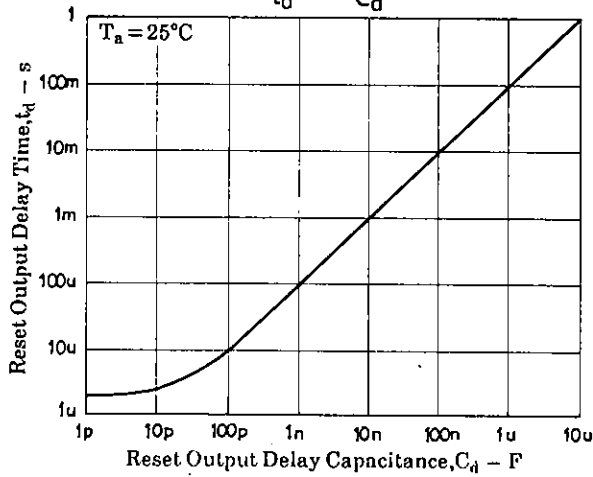
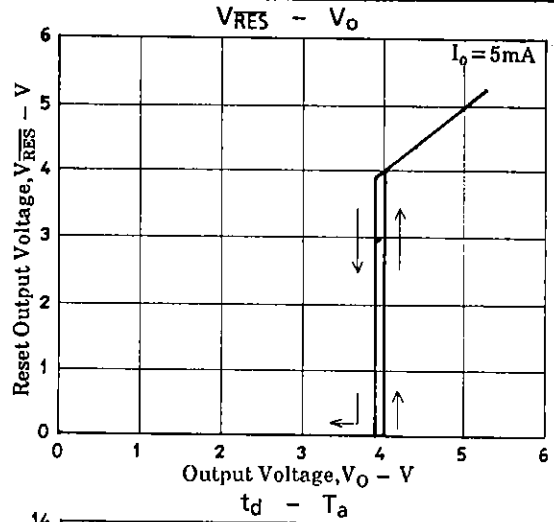
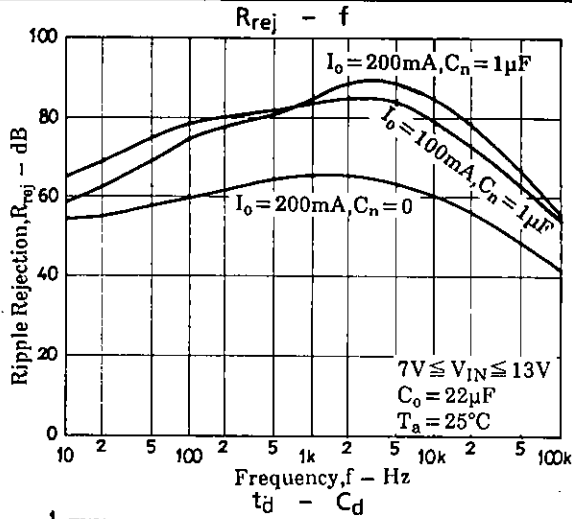

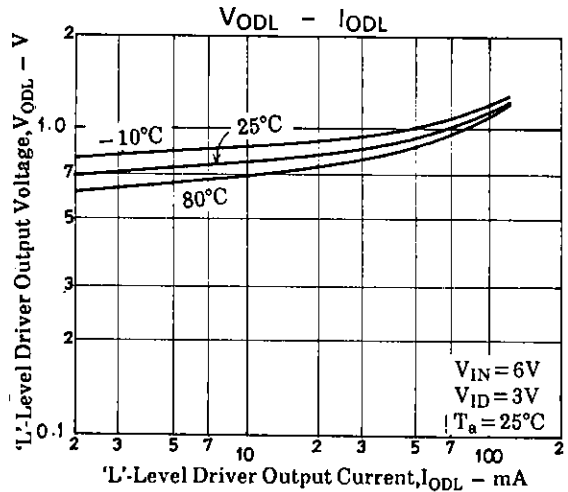
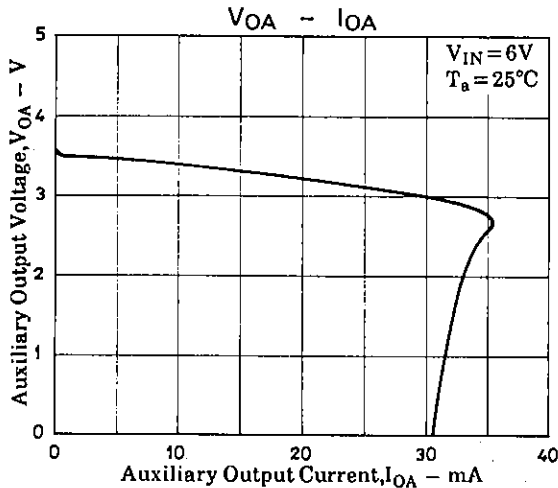
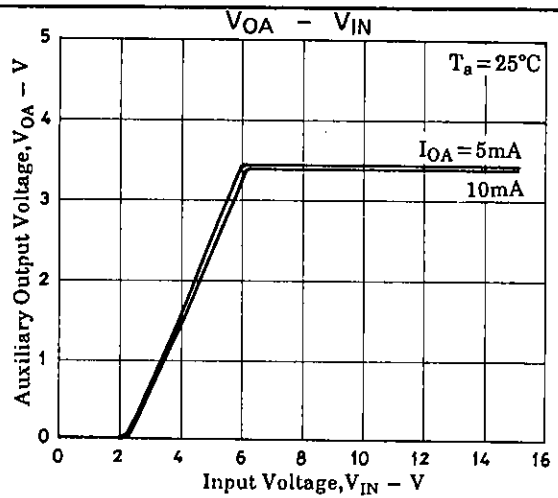
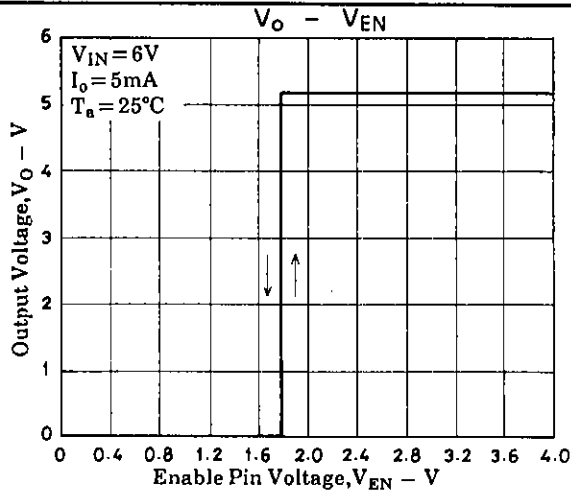

Delay Start Application Circuit Characteristics $V_{IN}, V_O - t$

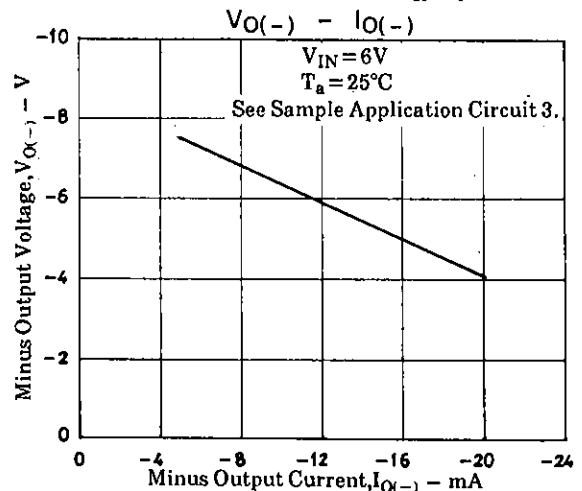
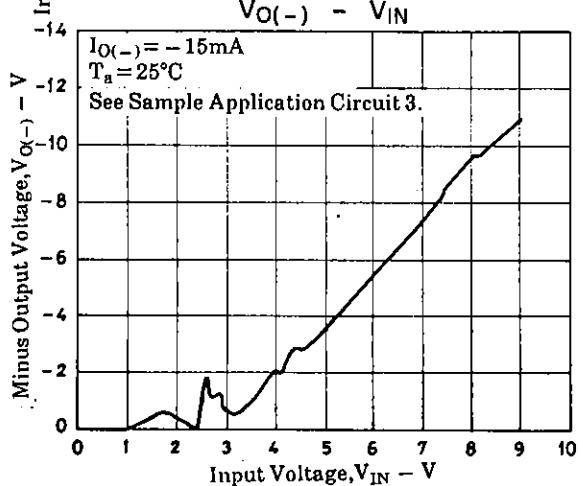
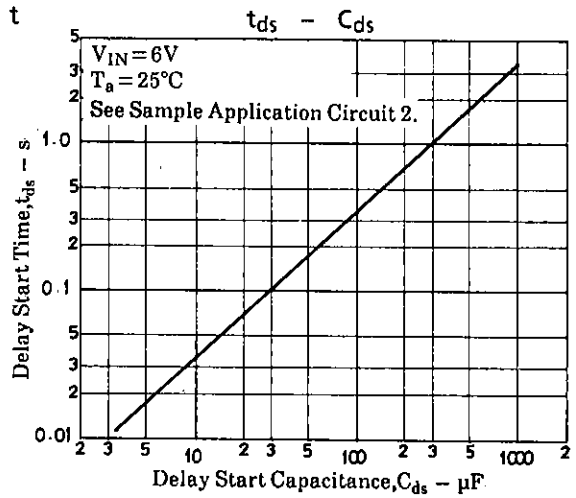
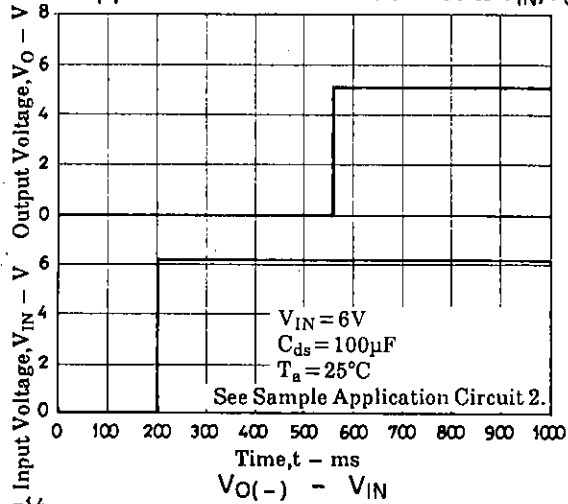

- No products described or contained herein are intended for use in surgical implants, life-support systems, aerospace equipment, nuclear power control systems, vehicles, disaster/crime-prevention equipment and the like, the failure of which may directly or indirectly cause injury, death or property loss.
- Anyone purchasing any products described or contained herein for an above-mentioned use shall:
 - ① Accept full responsibility and indemnify and defend SANYO ELECTRIC CO., LTD., its affiliates, subsidiaries and distributors and all their officers and employees, jointly and severally, against any and all claims and litigation and all damages, cost and expenses associated with such use:
 - ② Not impose any responsibility for any fault or negligence which may be cited in any such claim or litigation on SANYO ELECTRIC CO., LTD., its affiliates, subsidiaries and distributors or any of their officers and employees jointly or severally.
- Information (including circuit diagrams and circuit parameters) herein is for example only; it is not guaranteed for volume production. SANYO believes information herein is accurate and reliable, but no guarantees are made or implied regarding its use or any infringements of intellectual property rights or other rights of third parties.

This catalog provides information as of September, 1995. Specifications and information herein are subject to change without notice.