

SANYO	No.3245A	LA5317M
		Monolithic Linear IC Variable Divided Voltage Generator for LCD Use

Overview

The LA5317M is a variable divided voltage generator IC for multiple drive of LCD matrix.

Features

- Power supply for variable bias LCD drive (1/5 to 1/20 bias available by on-chip resistances)
- 5 OP amps to deliver 5 voltage outputs
- Low current dissipation (1.6mA typ)
- Miniflat package

Maximum Ratings at Ta = 25°C

			unit
Maximum Supply Voltage	$V_{EE\ max}$	$V_{CC}-V_{EE}$	-38 to 0 V
Maximum Output Current	$I_{OUT\ max}$	V_1 to V_5	*±25 mA
Allowable Power Dissipation	$P_d\ max$		800 mW
Operating Temperature	T_{opr}		-20 to +75 °C
Storage Temperature	T_{stg}		-30 to +125 °C

Note 1) Continuous operation (nonbreakdown) is guaranteed when operated at the maximum ratings shown above.

Note 2)* The maximum output current is a value specified under the conditions otherwise specified separately.

Operating Conditions at Ta = 25°C

			unit
Supply Voltage	V_{EE}	$V_{CC}-V_{EE}$	-35 to -10 V
Output Current	I_{OUT1}	V_1	-0.5 to +10 mA
	$I_{OUT2,3}$	V_2, V_3	-10 to +10 mA
	$I_{OUT4,5}$	V_4, V_5	-15 to +0.5 mA

Note 3) Set V_{CC}, V_{EE} so that $|V_1|, |V_5-V_4|$ become 1V or greater.

Package Dimensions 3073A-M30IC
(unit: mm)

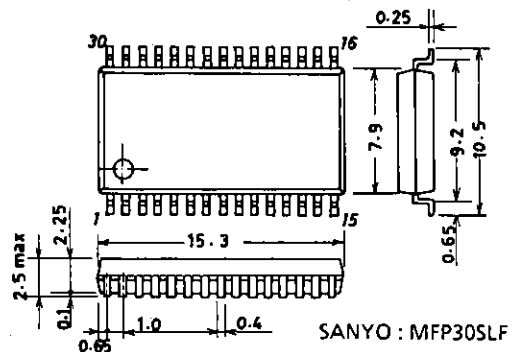

LA5317M

Operating Characteristics at $T_a = 25^\circ\text{C}$, $V_{CC} - V_{EE} = 20\text{V}$, $V_{REF} = V_{EE}$, $R_X = 8\text{R}$

			min	typ	max	unit
Current Dissipation	I_{CC}, I_{EE}	$V_{CC}, V_{EE} : V_{CC} - V_{EE} = 20\text{V}$, $R_X = 8\text{R}$		1.6	3	mA
Output Voltage Ratio	1	Ra1	V_2/V_1	1.96	2.00	2.04
	2	Ra2	$(V_5 - V_3)/(V_5 - V_4)$	1.96	2.00	2.04
	3	Rb1	V_5/V_1	11.64	12.00	12.36
	4	Rb2	V_5/V_2	5.82	6.00	6.18
	5	Rb3	$V_5/(V_5 - V_3)$	5.82	6.00	6.18
	6	Rb4	$V_5/(V_5 - V_4)$	11.64	12.00	12.36
Internal Resistance Ratio	1	8R	$R_{X1} - R_{X2}$		8	
	2	12R	$R_{X1} - R_{X3}$	Resistance ratio referenced to R across R_{X5} and R_{X6}	12	
	3	14R	$R_{X1} - R_{X4}$		14	
	4	15R	$R_{X1} - R_{X5}$		15	
	5	16R	$R_{X1} - R_{X6}$		16	
Resistance	R	R value when 0.5V is applied across R_{X5} and R_{X6} .			20	
Load Regulation	1	ΔV_1	$V_1 : -0.2\text{mA} < I_{OUT1} < +10.0\text{mA}$		± 20	mV
	2	ΔV_2	$V_2 : -0.2\text{mA} < I_{OUT2} < +10.0\text{mA}$		± 20	mV
	3	ΔV_3	$V_3 : -0.2\text{mA} < I_{OUT3} < +10.0\text{mA}$		± 20	mV
	-2	$-\Delta V_2$	$V_2 : -10.0\text{mA} < I_{OUT2} < +0.2\text{mA}$		± 20	mV
	-3	$-\Delta V_3$	$V_3 : -10.0\text{mA} < I_{OUT3} < +0.2\text{mA}$		± 20	mV
	-4	$-\Delta V_4$	$V_4 : -10.0\text{mA} < I_{OUT4} < +0.2\text{mA}$		± 20	mV
	-5	$-\Delta V_5$	$V_5 : -10.0\text{mA} < I_{OUT5} < +0.2\text{mA}$		± 20	mV

Equivalent Circuit Block Diagram

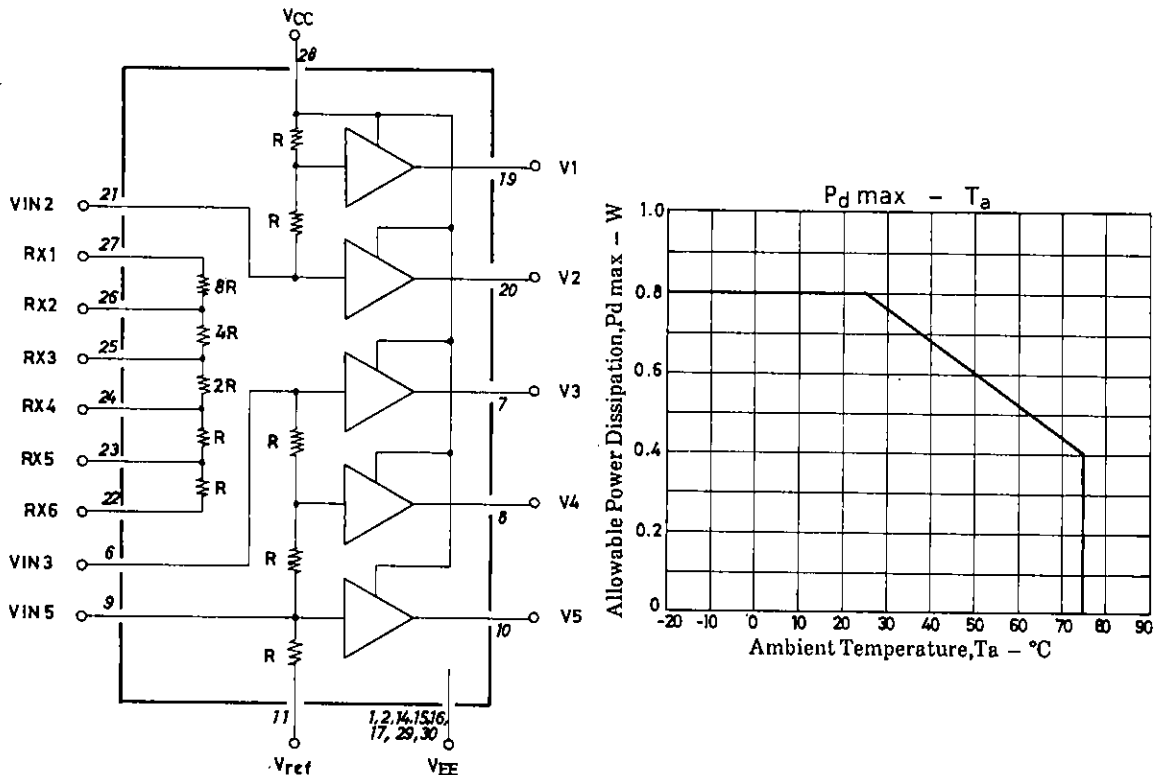

LA5317M

Pin Assignment

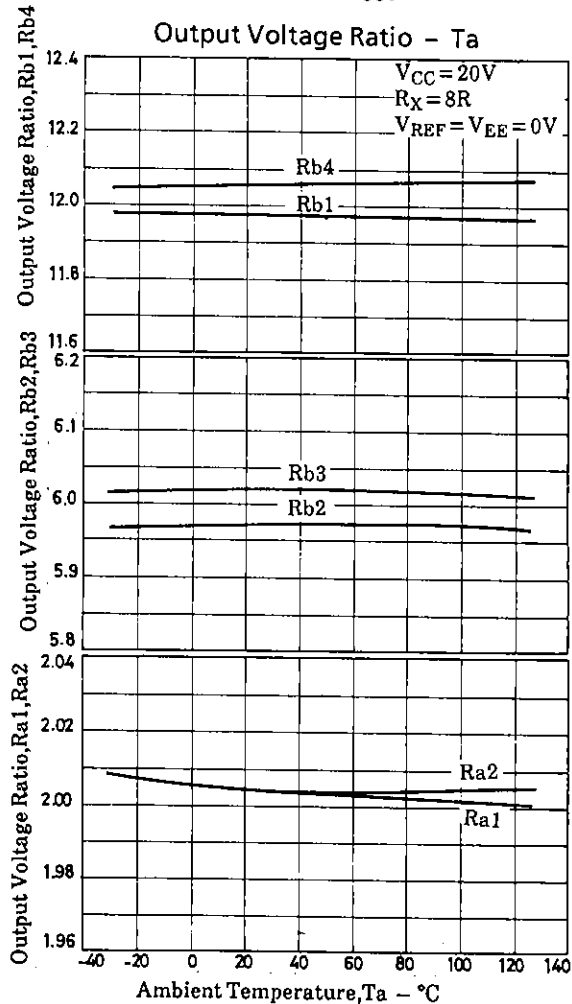
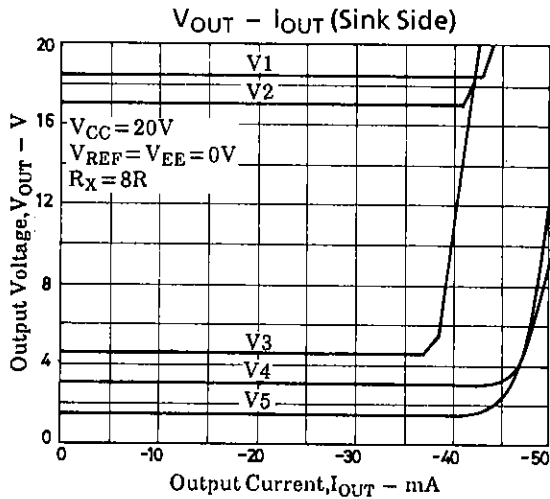
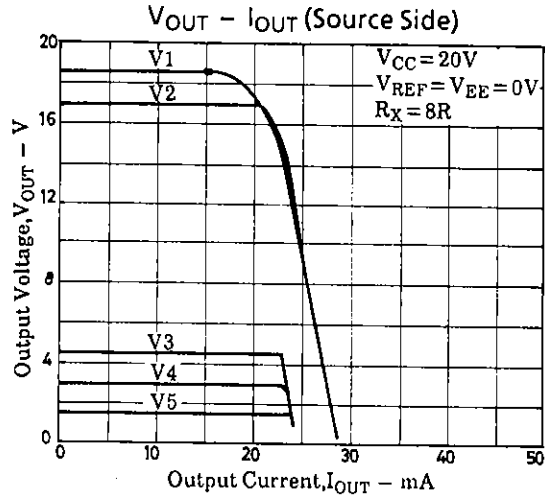
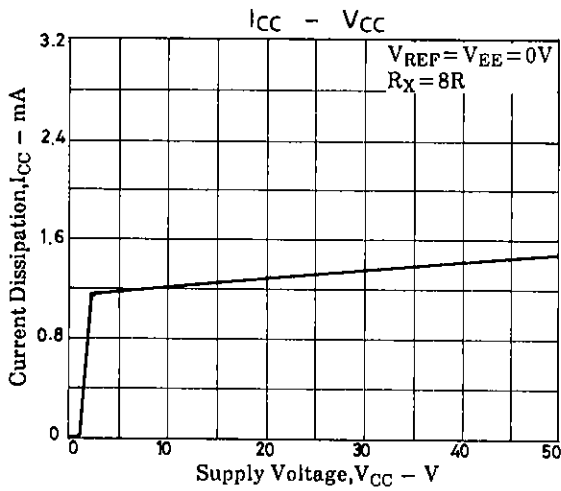
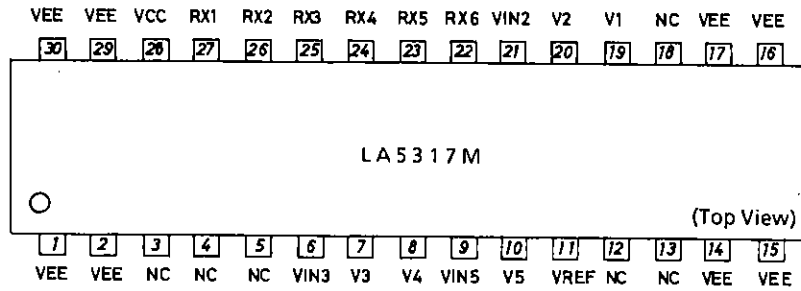

- No products described or contained herein are intended for use in surgical implants, life-support systems, aerospace equipment, nuclear power control systems, vehicles, disaster/crime-prevention equipment and the like, the failure of which may directly or indirectly cause injury, death or property loss.
- Anyone purchasing any products described or contained herein for an above-mentioned use shall:
 - ① Accept full responsibility and indemnify and defend SANYO ELECTRIC CO., LTD., its affiliates, subsidiaries and distributors and all their officers and employees, jointly and severally, against any and all claims and litigation and all damages, cost and expenses associated with such use:
 - ② Not impose any responsibility for any fault or negligence which may be cited in any such claim or litigation on SANYO ELECTRIC CO., LTD., its affiliates, subsidiaries and distributors or any of their officers and employees jointly or severally.
- Information (including circuit diagrams and circuit parameters) herein is for example only; it is not guaranteed for volume production. SANYO believes information herein is accurate and reliable, but no guarantees are made or implied regarding its use or any infringements of intellectual property rights or other rights of third parties.