



LA4800V

3 V Stereo Headphone Power Amplifier

Overview

The LA4800V is a headphone stereo power amplifier IC that features a high signal-to-noise ratio, high ripple rejection, low distortion and low current consumption, making it ideal for portable CD players.

Functions

- Headphone stereo power amplifier
- Beep tone
- Power switch
- Power mute switch

Features

- 96 dB (typ) high S/N ratio at 7 μ V
- 76 dB (typ) high ripple rejection
- 0.07% (typ) low distortion with $R_L = 16 \Omega$
- 6.2 mA (typ) low current consumption
- Outputs do not require electrolytic capacitors.
- Available in 16-pin SSOPs

Package Dimensions

unit : mm

3178-SSOP16

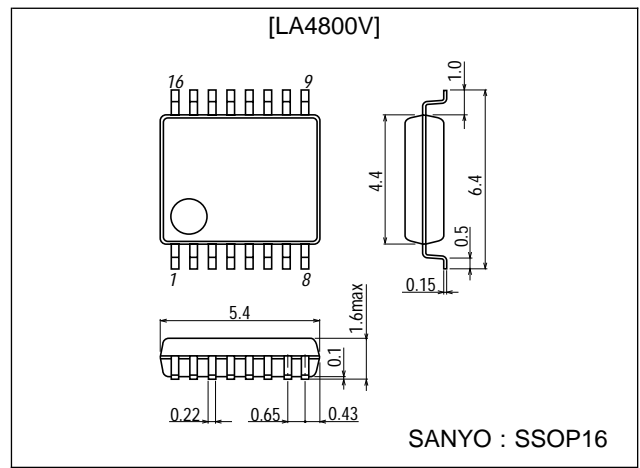

Specifications

Maximum Ratings at $T_a = 25^\circ\text{C}$

Parameter	Symbol	Conditions	Ratings	Unit
Maximum supply voltage	$V_{CC \text{ max}}$		4.5	V
Power dissipation	$P_d \text{ max}$		375	mW
Operating temperature range	T_{opr}		-15 to +50	$^\circ\text{C}$
Storage temperature range	T_{stg}		-40 to +150	$^\circ\text{C}$

■ Any and all SANYO products described or contained herein do not have specifications that can handle applications that require extremely high levels of reliability, such as life-support systems, aircraft's control systems, or other applications whose failure can be reasonably expected to result in serious physical and/or material damage. Consult with your SANYO representative nearest you before using any SANYO products described or contained herein in such applications.

■ SANYO assumes no responsibility for equipment failures that result from using products at values that exceed, even momentarily, rated values (such as maximum ratings, operating condition ranges, or other parameters) listed in products specifications of any and all SANYO products described or contained herein.

SANYO Electric Co.,Ltd. Semiconductor Company

TOKYO OFFICE Tokyo Bldg., 1-10, 1 Chome, Ueno, Taito-ku, TOKYO, 110-8534 JAPAN

32896HA(II)/60393TS No.4335-1/11

LA4800V

Recommended Operating Ranges at $T_a = 25^\circ\text{C}$

Parameter	Symbol	Conditions	Ratings	Unit
Supply voltage	V_{CC}		3.0	V
Load resistance	R_L		16 to 32	Ω
Operating supply voltage range	$V_{CC\text{ op}}$		1.8 to 3.6	V

Operating Characteristics at $T_a = 25^\circ\text{C}$, $V_{CC} = 2.5\text{ V}$, $R_L = 16\ \Omega$, $f = 1\text{ kHz}$ unless otherwise noted. Values in parentheses indicate $V_{CC} = 3.0\text{ V}$

Parameter	Symbol	Conditions	min	typ	max	Unit
Quiescent supply current	I_{CCO1}	IC OFF		0.05	1.0	μA
	I_{CCO2}	Mute ON		1.6 (1.65)	3.0	mA
	I_{CCO3}	No input signal		6.2 (6.8)	9.0	mA
Voltage gain	VG	$V_O = -10\text{ dBm}$	10.3	11.8	13.3	dB
Channel balance	V_{RL}	$V_O = -10\text{ dBm}$	-1	0	+1	dB
Output power	P_O	$V_{CC} = 3.0\text{ V}$, THD = 10%	15	25		mW
Total harmonic distortion	THD	$V_O = 0.35\text{ V}$		0.075	0.2	%
Output noise voltage	V_{NO}	$R_g = 1\text{ k}\Omega$, DIN AUDIO		7.8	15	μV
Crosstalk	CT	$f = 1\text{ kHz}$, TUN, $V_O = -10\text{ dBm}$	35	45		dB
Ripple rejection	R.R	$V_{CC} = 1.7\text{ V}$, $f = 100\text{ Hz}$, $V_{CR} = -20\text{ dBm}$, TUN = 100 Hz	65	76		dB
Mute attenuation	V_{OFF}	THD = 1%	-80	-96		dB
Beep tone output voltage	$V_{O\text{ BEEP}}$	$V_I = -13.5\text{ dBm}$ (sine wave)	1.5	3.0		mV
Output DC offset voltage	$V_{DC\text{ OFF}}$	$V_I = 0\text{ V}$, $R_g = 1\text{ k}\Omega$	-20	0	+20	mV
Power ON current sensitivity	$I_{1\text{ ON}}$	$V_{CC} = 1.7\text{ V}$, $V_5 \geq 1.0\text{ V}$		50	60	μA
Power OFF voltage sensitivity	$V_{1\text{ OFF}}$	$V_{CC} = 1.7\text{ V}$, $V_5 \leq 0.1\text{ V}$	0.5	0.6		V
Mute OFF current sensitivity	$I_{16\text{ OFF}}$	$V_{CC} = 1.7\text{ V}$, $V_5 \geq 1.0\text{ V}$		4.5	6.0	μA
Mute OFF voltage sensitivity	$V_{16\text{ OFF}}$	$V_{CC} = 1.7\text{ V}$	1.0	1.25	1.5	V
Mute ON voltage sensitivity	$V_{16\text{ ON}}$	$V_{CC} = 1.7\text{ V}$		0.9	1.0	V

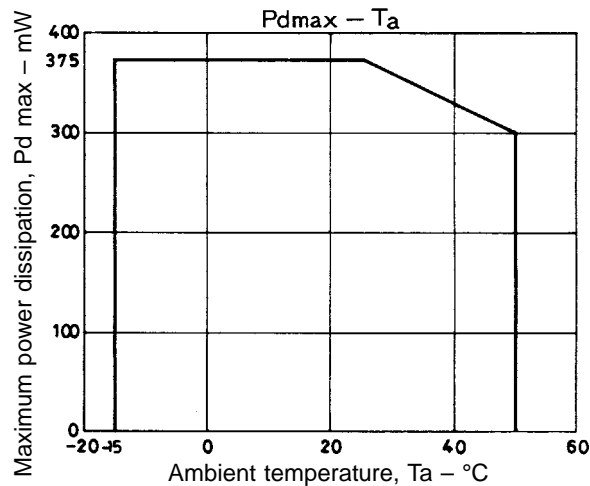

LA4800V

Pin Assignment and Block Diagram

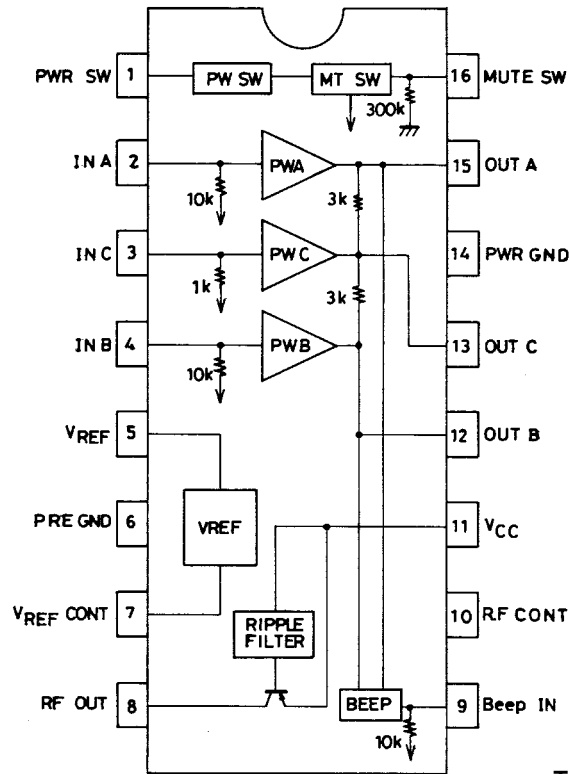

Top view

Unit (resistance: Ω)

Test Circuit

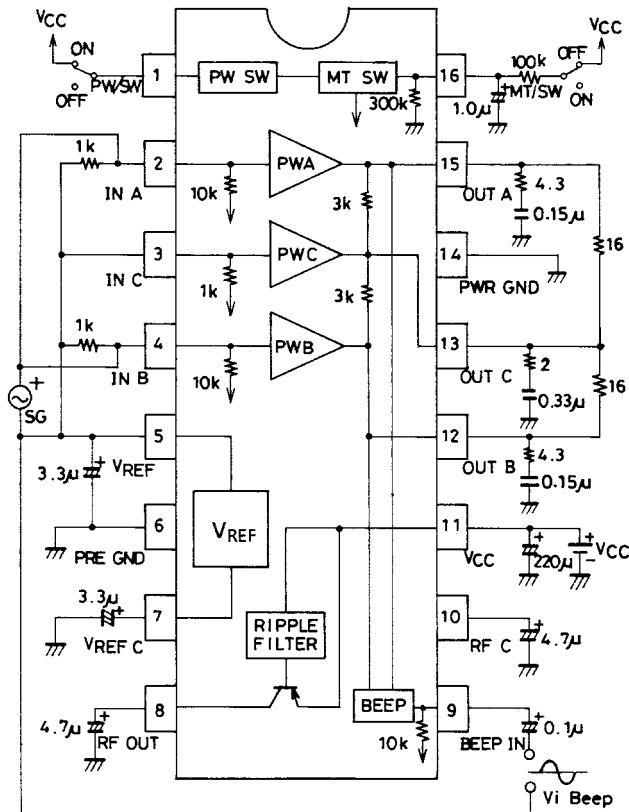

Unit (resistance: Ω , capacitance: F)

Sample Application Circuit

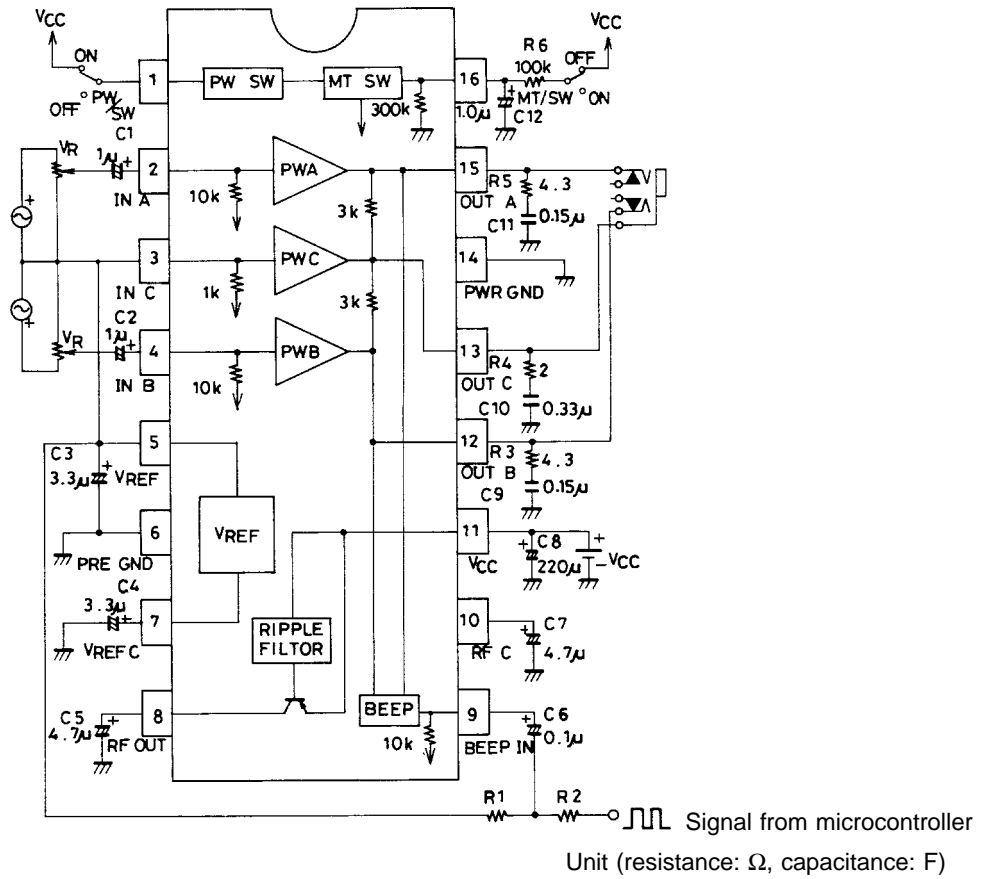

Pin Description

V_{CC} = 2.5 V

Unit (resistance: Ω)

Pin number	Pin name	V _{DC} (V)	Equivalent circuit	Pin description
1	PWR SW	0 to 0.7		Power switch Turns ON the power to the V _{CC} pin.
2	IN A	1.1		Power input pins 10 kΩ input resistance
4	IN B			
3	IN C	1.1		Power amplifier common input pin Usually connected to V _{ref}

Continued on next page.

LA4800V

Continued from preceding page.

Unit (resistance: Ω)

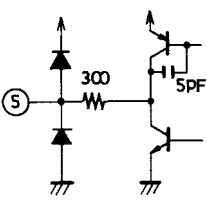
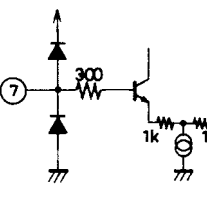
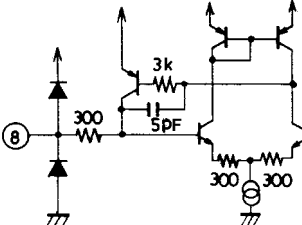
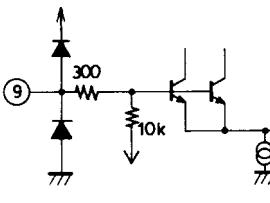
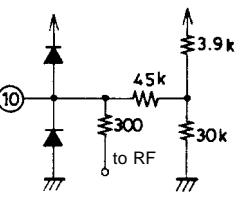
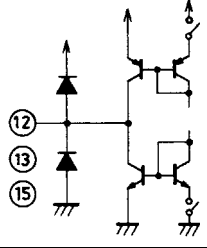
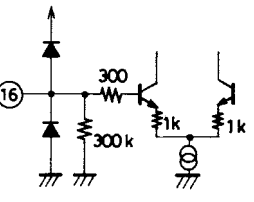
Pin number	Pin name	V _{DC} (V)	Equivalent circuit	Pin description
5	V _{REF} OUT	1.1		1.1 V fixed bias
6	PRE GND			Preamplifier ground
7	V _{REF} CONT	1.1		1.1 V reference control pin
8	RF OUT	2.2		Preset to approximately V _{CC} × 0.88 V
9	Beep IN	1.1		Beep tone input pin Active only when mute is ON.
10	RF CONT	2.2		RF control pin
11	V _{CC}			Power supply
12 13 15	OUT B OUT C OUT A	1.1 1.1 1.1		Power output pins Pin 13 is the headphone center common drive. (No electrolytic capacitors required)
14	PWR GND			Power amplifier ground
16	MUTE SW	0 to 1.85		The mute pin is floating when ON, and tied to V _{CC} through a 100 k Ω when OFF.

LA4800V

External Components Description

Components	Recommended value	Description
C1, C2	1 to 4.7 μ F	Input coupling capacitors
C3, C4	3.3 to 10 μ F	Reference bias (V_{REF}) decoupling capacitors
C5, C4	4.7 to 10 μ F	Ripple filter capacitors. Increasing the capacitance also increases the distortion and the supply rise time at turn ON.
C6	0.1 to 1 μ F	Input coupling capacitor for the beep tone. Choose a value that does not attenuate the beep tone signal.
C8	220 μ F	Supply line coupling capacitor
C9, C10, C11	0.22 to 0.47 μ F	Oscillation damping capacitors. Film capacitors are recommended.
C12	0.1 to 1.0 μ F	Mute time setting capacitor. See the description in the Operating Notes.
R1, R2		Beep tone input signal adjustment resistors. Follow the manufactures instructions.
R3, R4, R5	0.5 to 4.3 Ω	Power amplifier oscillation damping resistors.
R6	100 k Ω	Mute OFF pin 16 bias setting resistor. The internal 300 k Ω resistor and this 100 k Ω resistor together set the mute switch (pin 16) threshold.

Operating Notes

Beep tone operating principle

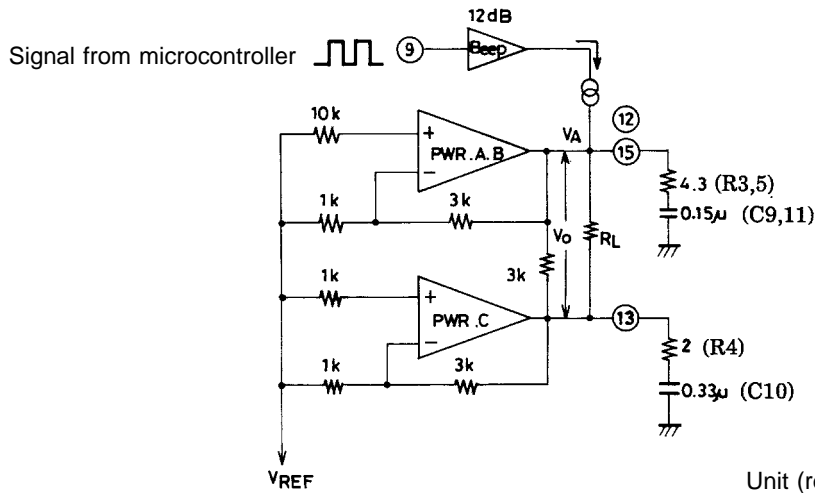

The design of the above when mute is ON (pin 16 open) is as follows:

The output voltage V_O as function of R_L is

$$V_O = \frac{R_L}{R_L + 3k + 1k} \times V_A$$

For example, if $R_L = 16 \Omega$ and $V_A = 0.5 \text{ V}$ (V_A is the adjusted input voltage on pin 9),

$$V_O = \frac{16\Omega}{16\Omega + 3k + 1k} \times 0.5 \cong 2 \text{ mV}$$

The beep tone output voltage V_O is determined by the above equation. However, the oscillation damping RC components are connected to the PWR output and hence these RC components will also influence the actual value of V_O . When using the beep tone, the impedance of C10, connected to the common output (pin 13), must be greater than the impedance of C9 and C11, i.e. C10 must be greater than C9 and C11.

Mute time adjustment

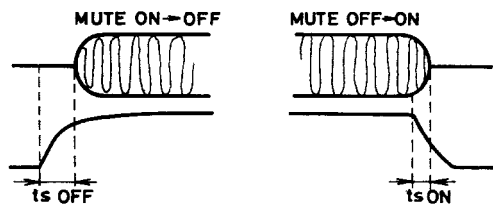
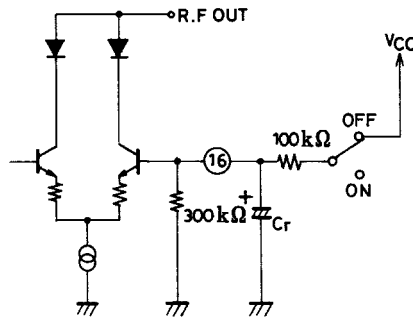

The mute ON/OFF switching waveforms are shown in the figure above. The settling time t_s is determined by the capacitor C_r connected to pin 16. The recommended value of C_r is 1 μF . If the value used is less than 1 μF , pop noise will increase.

The setting time for different values of C_r are shown in the table below.

C_r (μF)	t_s OFF(ms)	t_s ON (ms)
0.1	15	3.2
1.0	150	30
2.2	300	56

LA4800V

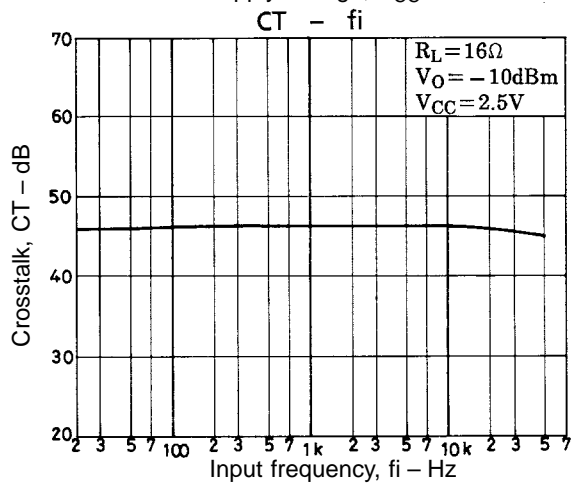
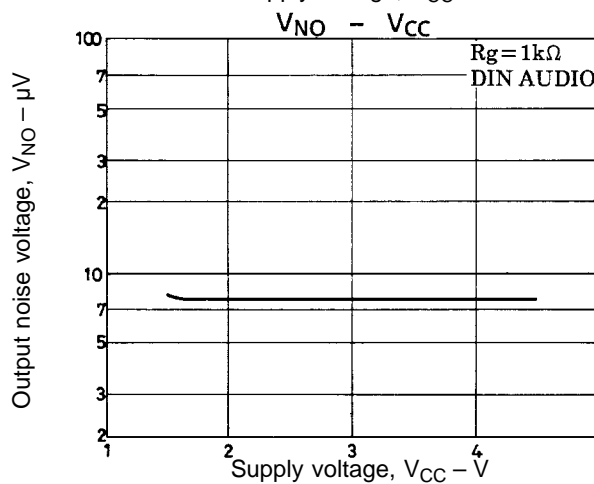
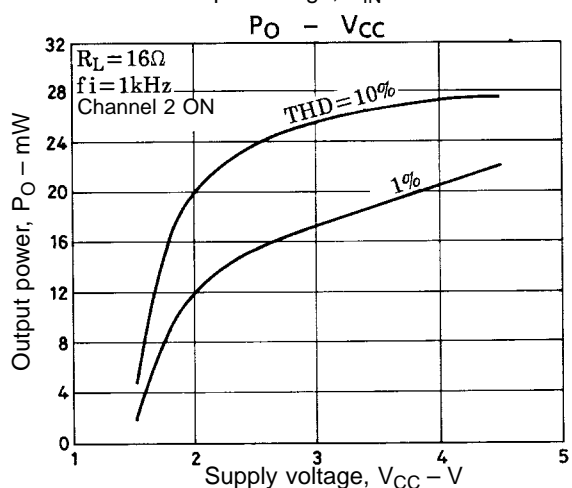
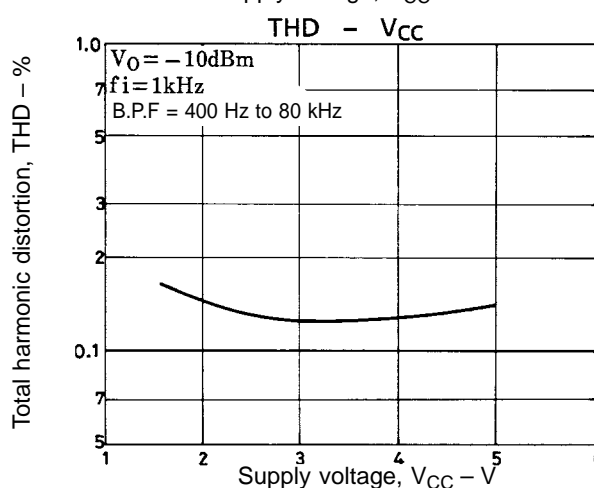
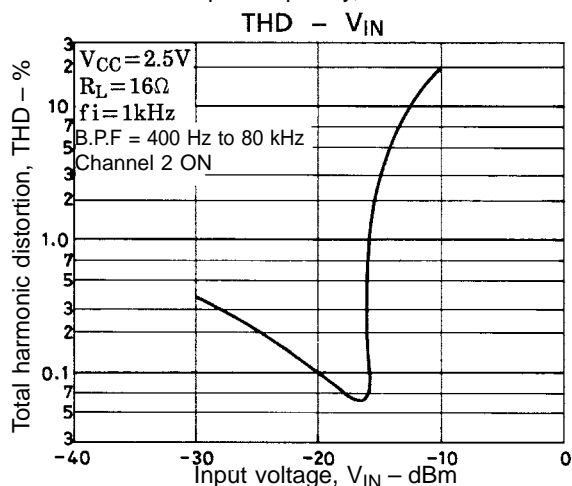
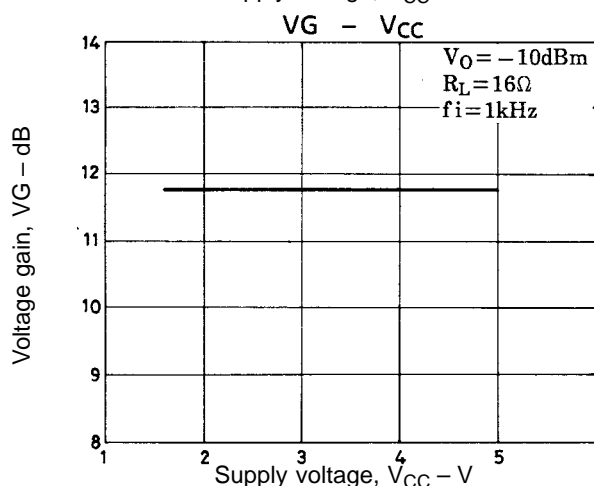
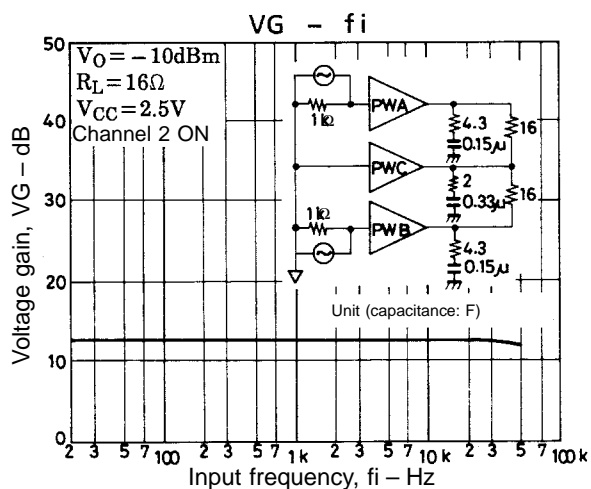
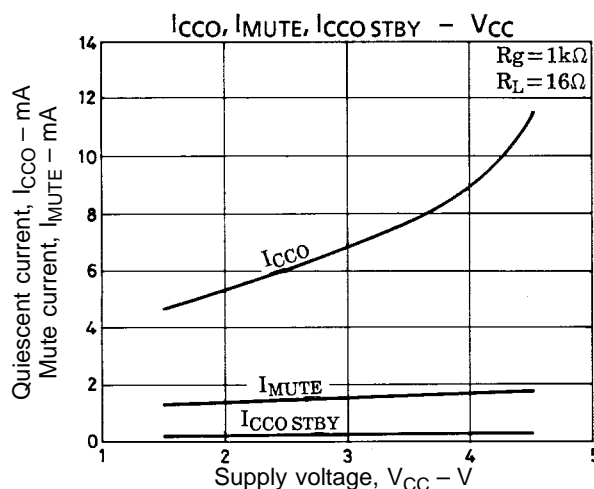

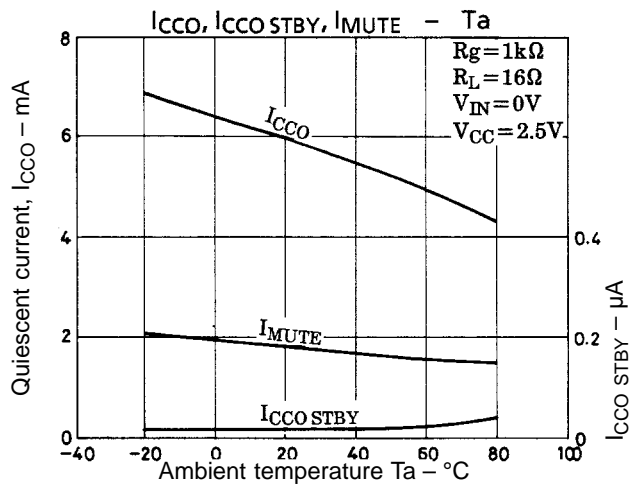
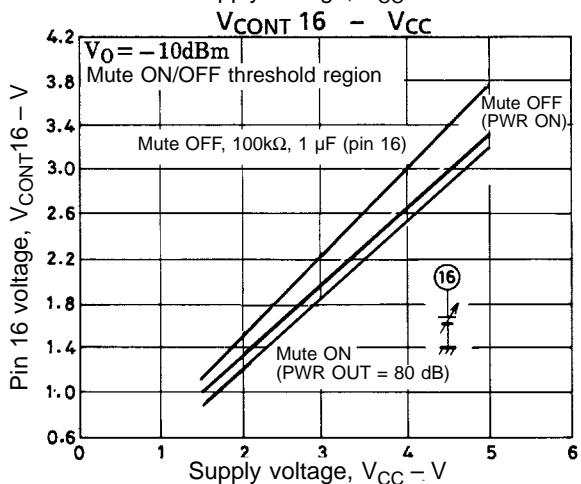
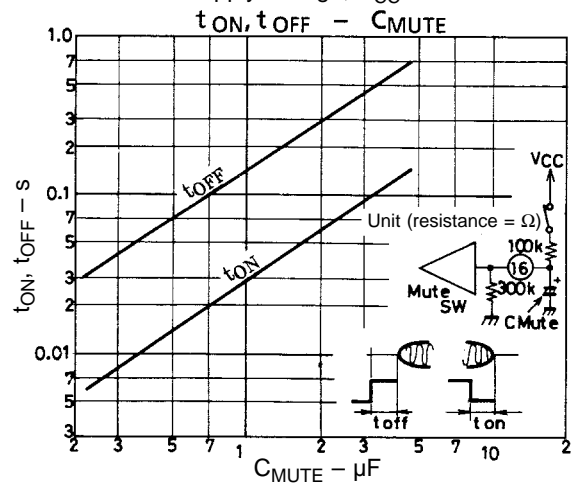
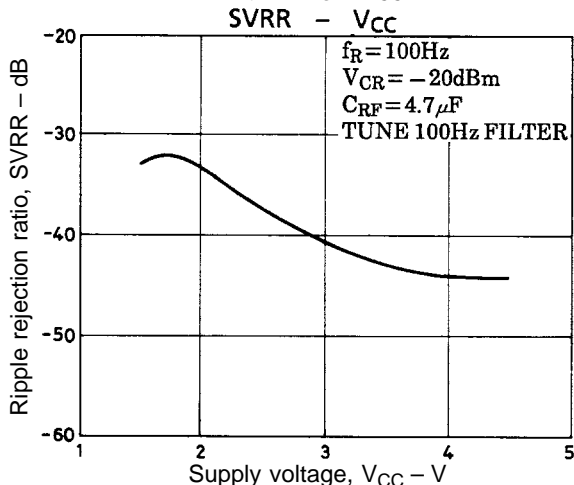
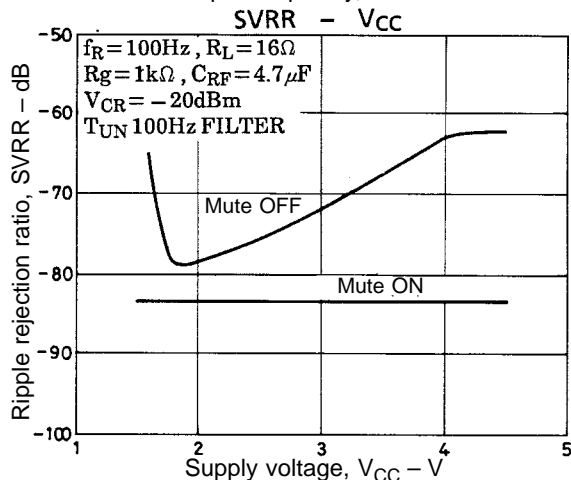
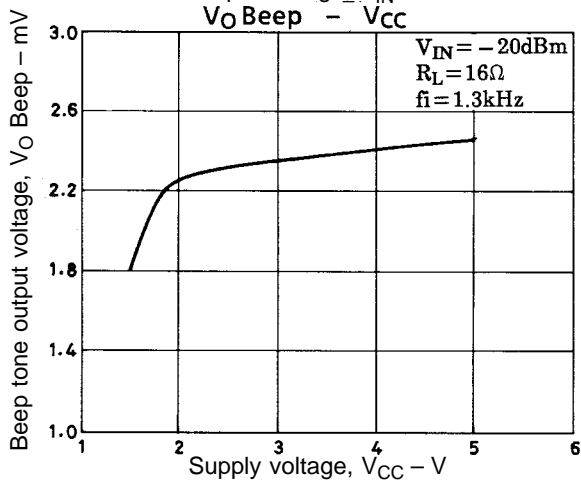
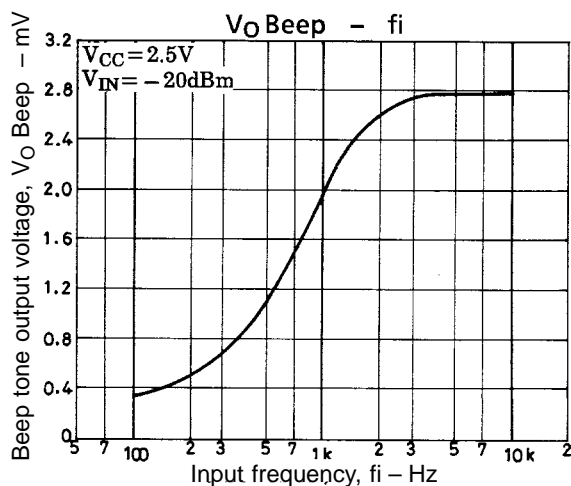
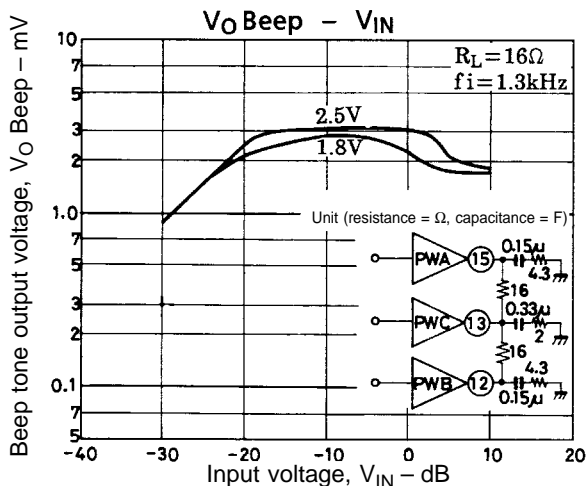

LA4800V

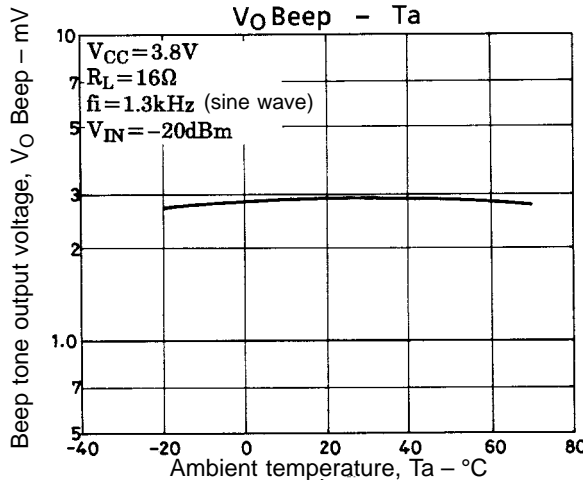
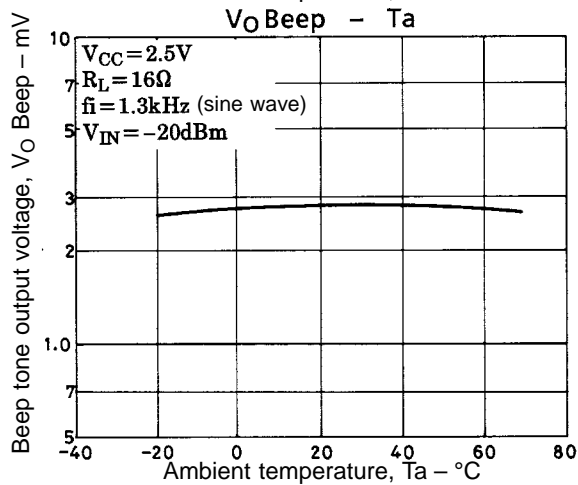
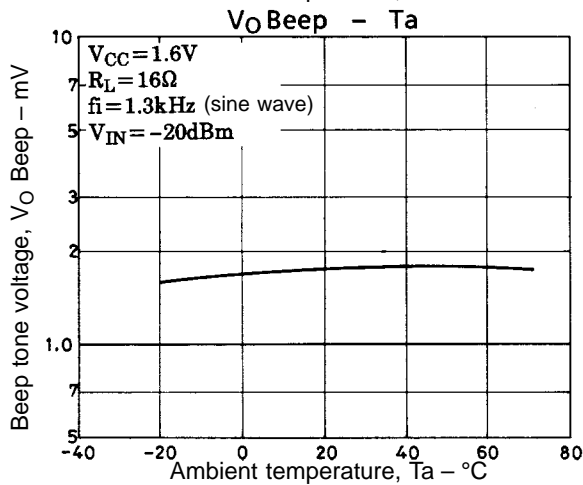
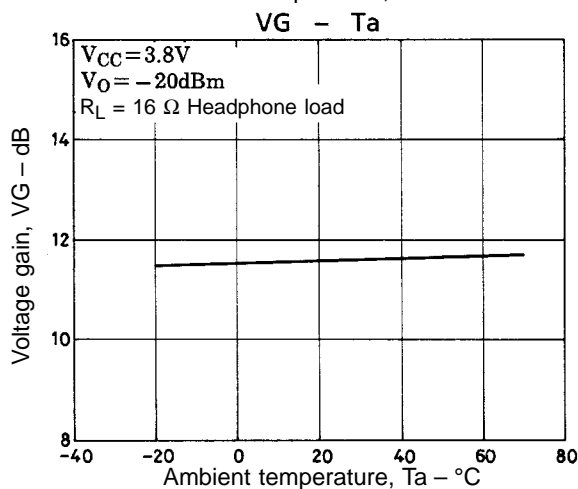
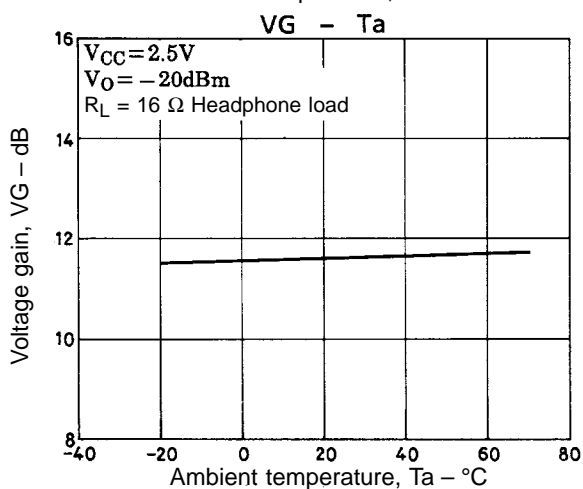
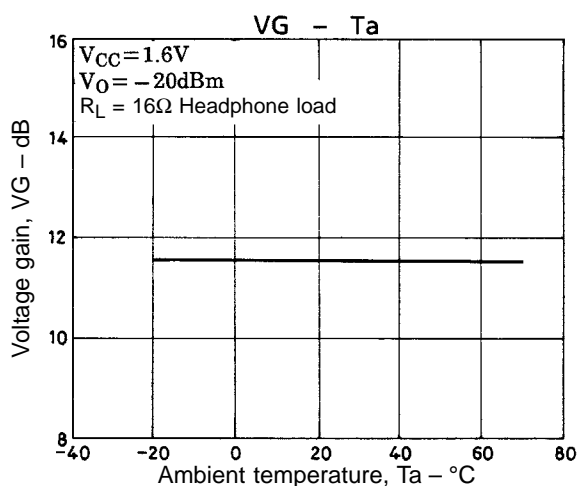
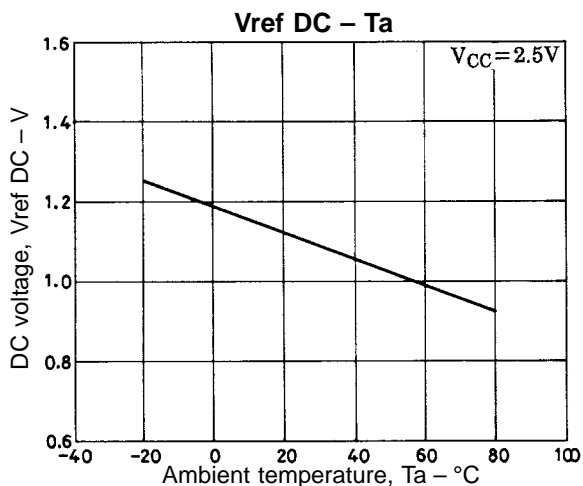

- Specifications of any and all SANYO products described or contained herein stipulate the performance, characteristics, and functions of the described products in the independent state, and are not guarantees of the performance, characteristics, and functions of the described products as mounted in the customer's products or equipment. To verify symptoms and states that cannot be evaluated in an independent device, the customer should always evaluate and test devices mounted in the customer's products or equipment.
- SANYO Electric Co., Ltd. strives to supply high-quality high-reliability products. However, any and all semiconductor products fail with some probability. It is possible that these probabilistic failures could give rise to accidents or events that could endanger human lives, that could give rise to smoke or fire, or that could cause damage to other property. When designing equipment, adopt safety measures so that these kinds of accidents or events cannot occur. Such measures include but are not limited to protective circuits and error prevention circuits for safe design, redundant design, and structural design.
- In the event that any or all SANYO products(including technical data, services) described or contained herein are controlled under any of applicable local export control laws and regulations, such products must not be exported without obtaining the export license from the authorities concerned in accordance with the above law.
- No part of this publication may be reproduced or transmitted in any form or by any means, electronic or mechanical, including photocopying and recording, or any information storage or retrieval system, or otherwise, without the prior written permission of SANYO Electric Co., Ltd.
- Any and all information described or contained herein are subject to change without notice due to product/technology improvement, etc. When designing equipment, refer to the "Delivery Specification" for the SANYO product that you intend to use.
- Information (including circuit diagrams and circuit parameters) herein is for example only ; it is not guaranteed for volume production. SANYO believes information herein is accurate and reliable, but no guarantees are made or implied regarding its use or any infringements of intellectual property rights or other rights of third parties.

This catalog provides information as of March, 1996. Specifications and information herein are subject to change without notice.