

SANYO

No.3607A

LA4620**Two-channel Audio Power Amplifier****OVERVIEW**

The LA4620 is a two-channel high-power audio amplifier for automotive stereo and general-purpose audio amplification equipment.

The LA4620 has a 6 to 22 V operating supply voltage range. Each channel uses a bridge configuration to obtain high output power from low supply voltages. Typical output power is 17 W per channel.

The LA4620 incorporates a thermal protection circuit, an output short-circuit protection circuit and a pop suppression circuit. It has low-power, logic-level standby control and mute control inputs.

The LA4620 is available in 23-pin SIPs and operates from a 15 V supply.

FEATURES

- 17 W output power per channel
- 6 to 22 V supply voltage range
- Pop suppression
- Logic-controlled standby mode
- Thermal protection
- Short-circuit protection
- 60 dB channel separation
- 58 dB supply voltage ripple rejection
- 0.2% harmonic distortion
- 23-pin SIP

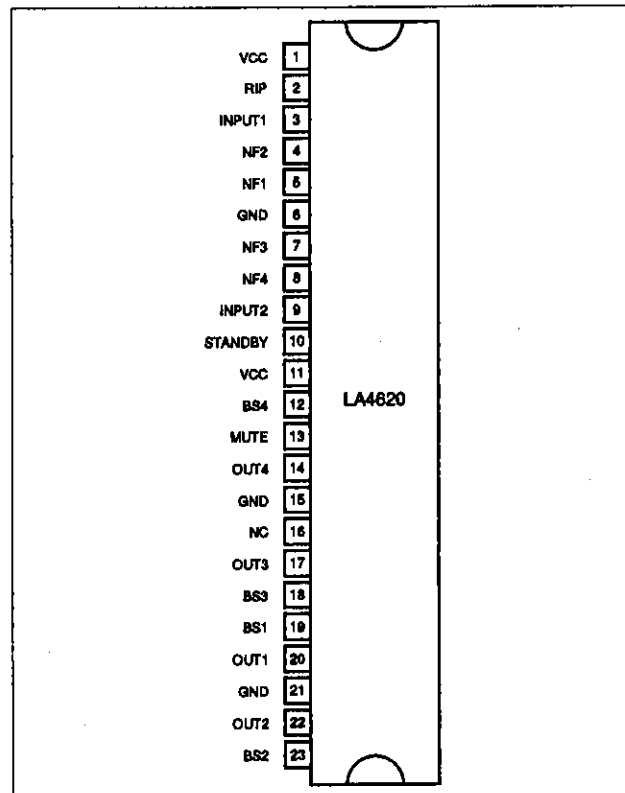
PINOUT**PACKAGE DIMENSIONS**

Unit: mm

SIP23HZ-3160

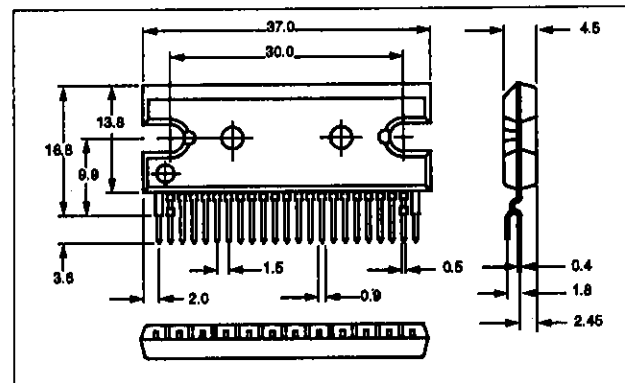

BLOCK DIAGRAM

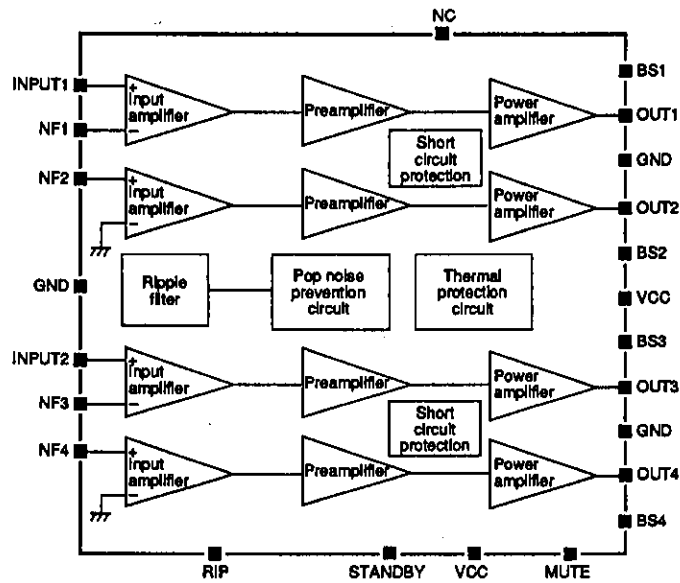

PIN DESCRIPTION

Number	Name	Description
1	VCC	Supply voltage
2	RIP	Ripple filter
3	INPUT1	Channel 1 input
4	NF2	Channel 1 negative feedback input
5	NF1	Channel 1 negative feedback input
6	GND	Ground
7	NF3	Channel 2 negative feedback input
8	NF4	Channel 2 negative feedback input
9	INPUT2	Channel 2 input
10	STANDBY	Standby switch
11	VCC	Supply voltage
12	BS4	Channel 2 bootstrap capacitor
13	MUTE	Muting control
14	OUT4	Channel 2 output
15	GND	Ground
16	NC	No connection
17	OUT3	Channel 2 output
18	BS3	Channel 2 bootstrap capacitor
19	BS1	Channel 1 bootstrap capacitor
20	OUT1	Channel 1 output
21	GND	Ground
22	OUT2	Channel 1 output
23	BS2	Channel 1 bootstrap capacitor

SPECIFICATIONS

Absolute Maximum Ratings

Parameter	Symbol	Rating	Unit
Supply voltage	V_{CC} max	24	V
Power dissipation	P_d max	37.5	W
Operating temperature range	T_{opr}	-20 to 75	deg. C
Storage temperature range	T_{stg}	-40 to 150	deg. C

Recommended Operating Conditions

$T_a = 25$ deg. C

Parameter	Symbol	Rating	Unit
Supply voltage	V_{CC}	12, 15	V
Supply voltage range	V_{CC}	6 to 22	V
Load resistance	R_L	4	Ω

Note

When operating at 22 V with a load of 4 Ω , ensure that the output power, P_o , does not exceed 1 W per channel.

Electrical Characteristics

$V_{CC} = 15$ V, $T_a = 25$ deg. C, $f_{IN} = 1$ kHz, $R_L = 4$ Ω , $R_g = 600$ Ω unless otherwise noted

Parameter	Symbol	Condition	Rating			Unit
			Min	Typ	Max	
Quiescent current	I_{CCO}		50	75	120	mA
Standby current	I_{ST}		–	1	10	μ A
Output power	P_{O1}	$V_{CC} = 12$ V, THD = 10%	10	13	–	W
	P_{O2}	$V_{CC} = 15$ V, THD = 10%	14	17	–	W
Total harmonic distortion	THD	$P_o = 1$ W	–	0.2	1.0	%
Input resistance	R_{IN}		17	24	31	k Ω
Voltage gain	VG		42	44	46	dB
Output noise voltage	V_{NO1}	$R_g = 0$ Ω , bandpass frequency range = 20 Hz to 20 kHz	–	0.2	0.5	mV
	V_{NO2}	$R_g = 10$ k Ω , bandpass frequency range = 20 Hz to 20 kHz	–	0.5	1.0	mV
Channel separation	SEP	$R_g = 10$ k Ω , $V_o = 0$ dBm	45	60	–	dB
Supply voltage ripple rejection	SVRR	$R_g = 0$ Ω , $f_R = 100$ Hz, $V_{CCR} = 0$ dBm	45	58	–	dB
Offset voltage	V_{OS}	$R_g = 0$ Ω	-180	–	180	mV

Typical Performance Characteristics

Output power vs. supply voltage

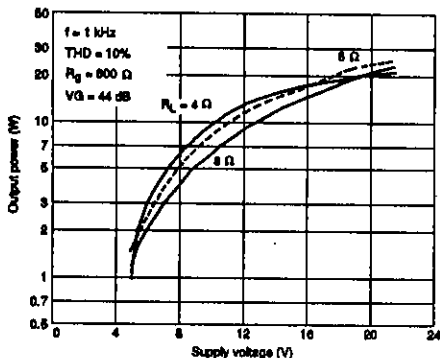

Channel separation vs. frequency

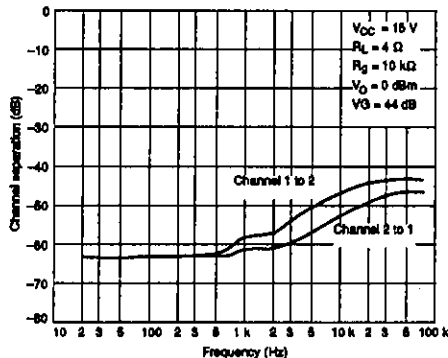

THD vs. output power (1)

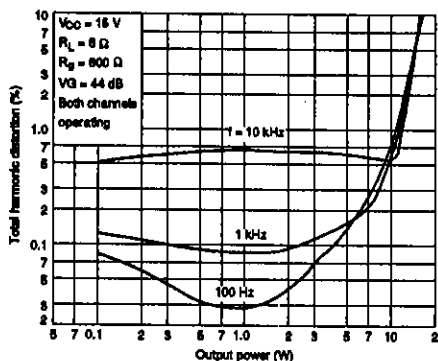

Supply voltage ripple rejection vs. ripple voltage

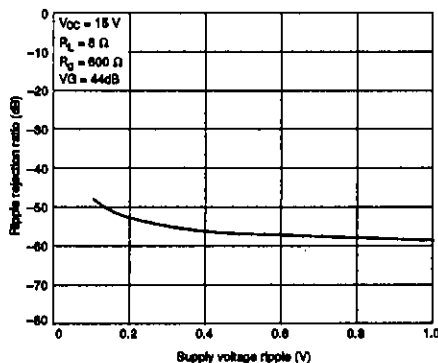

THD vs. output power (2)

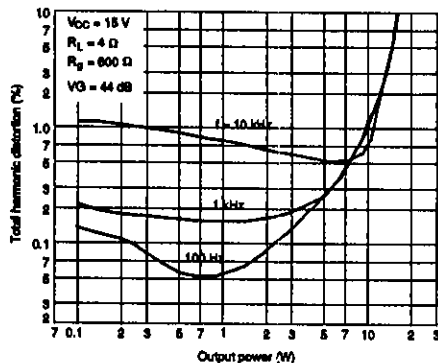

Supply voltage ripple rejection vs. supply voltage

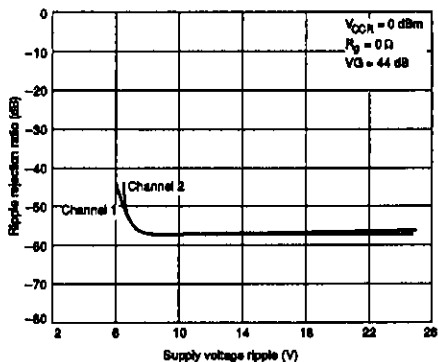

Frequency response

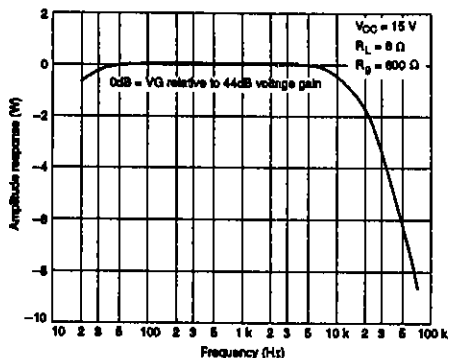

Quiescent and standby current vs. supply voltage

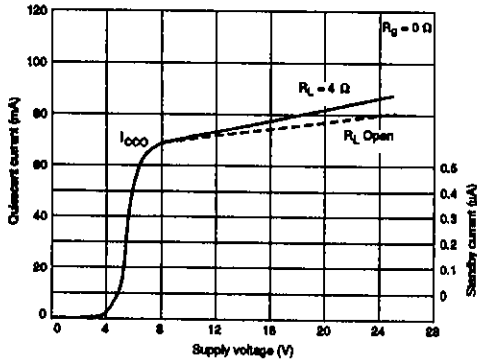

Noise voltage vs. source impedance

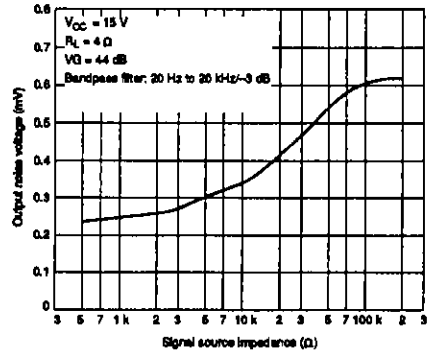

Power dissipation vs. output power

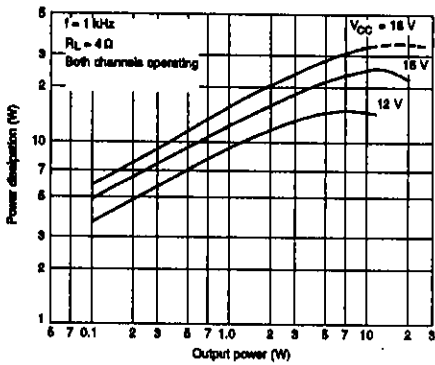

Noise voltage vs. supply voltage

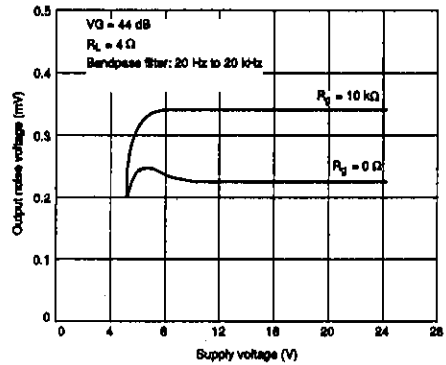

Supply current vs. output power

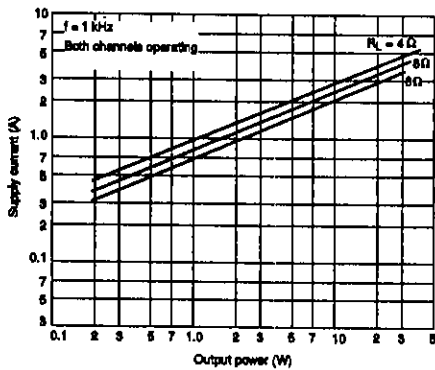

Total harmonic distortion vs. supply voltage

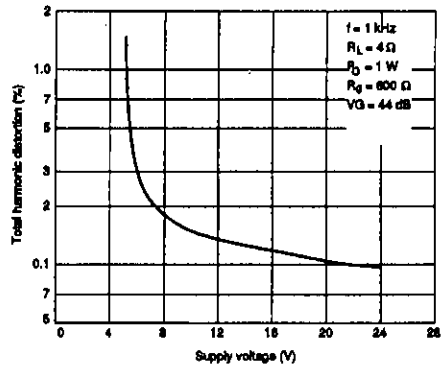

Maximum power dissipation vs. supply voltage

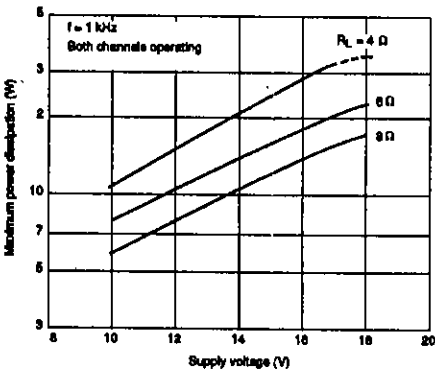

Quiescent current vs. ambient temperature

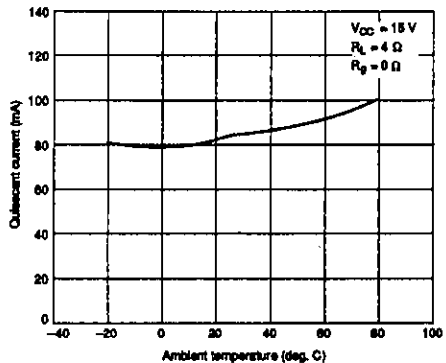

Output power vs. ambient temperature

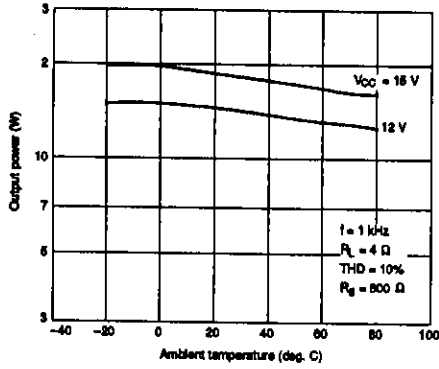

Maximum power dissipation vs. ambient temperature

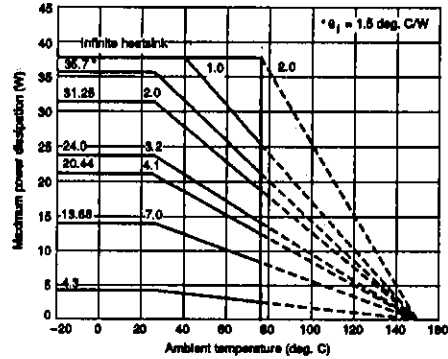

Startup time vs. C9

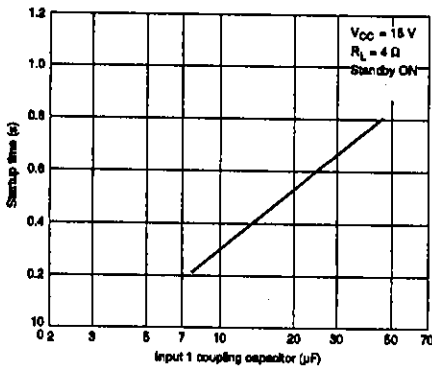

Maximum heatsink thermal resistance vs. surface area

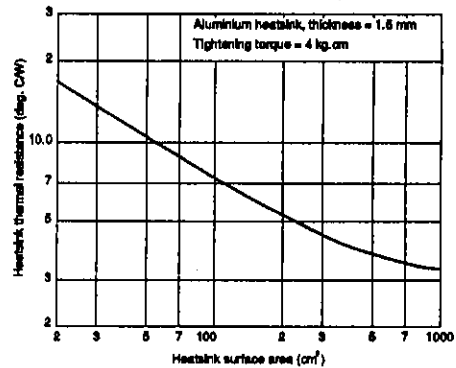

Standby switching characteristic

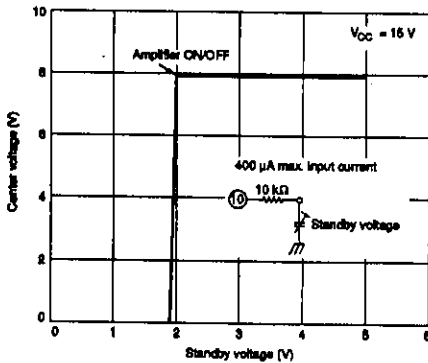

FUNCTIONAL DESCRIPTION

Standby Mode Control

Applying 1.5 V or more to R3 at STANDBY SW enables the amplifier. The maximum input current is 400 μ A.

Mute Control

Pulling MUTE to ground mutes the amplifier. The start-up time and recovery time when MUTE is pulled HIGH can be adjusted by changing C9.

Short-circuit Protection

The LA4620 incorporates a protection circuit for short circuits between output pins. However, this is inadequate for short circuits to ground or the supply. See the design notes.

PRINTED CIRCUIT BOARD LAYOUT

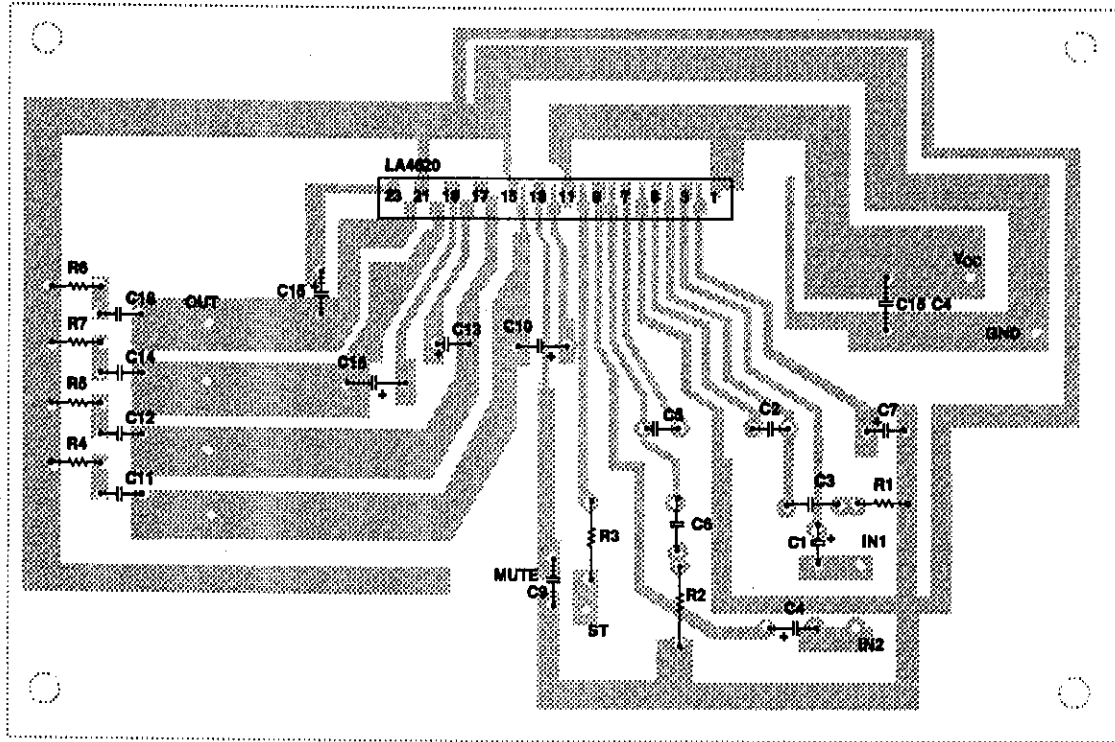

Note

Board size: 125 × 85 mm
 Surface finish: Copper foil

TYPICAL APPLICATION

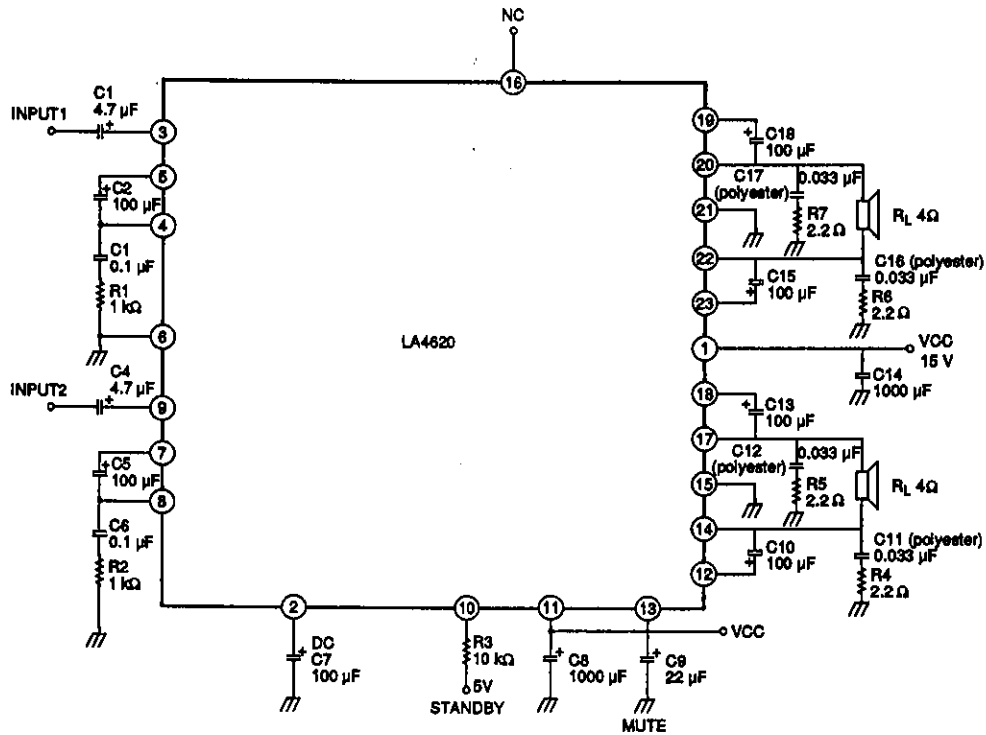

DESIGN NOTES

Input Capacitors

C1 and C4 are input coupling capacitors. They should both be 4.7 μF or less.

Feedback Capacitors

C2 and C5 form the negative feedback network. They should both be between 47 and 100 μF .

Supply Decoupling Capacitor

C7 should be 100 μF .

Supply Ripple Filter Capacitors

C8 and C14 smooth the supply voltage. Both should be at least 1,000 μF , and one of at least 2,000 μF can be used.

Startup Time Capacitor

C9 determines the amplifier startup time.

Bootstrapping Capacitors

C10, C13, C15 and C18 improve the device linearity for a wide range of input signals. These capacitors should be between 47 and 100 μF to improve the low-frequency response.

Oscillation Suppression

The R1 and C3, and R2 and C6 networks suppress oscillation. Use ceramic or mylar capacitors of 0.1 μF or more. Avoid using very large capacitances as these can cause high-frequency distortion.

C11, C12, C16, and C17 form RC networks with R4, R5, R6 and R7, respectively. Use mylar capacitors of 33 nF or more to prevent instability caused by circuit board layout.

Standby Control Current Limiting Resistor

R3 limits the current applied to STANDBY SW. It should be 10 Ω or more.

Heatsinking

The LA4620 should always be operated with a heatsink. If the heatsink does not provide adequate thermal dissipation, the thermal protection circuit will attenuate the signal level when the device overheats to prevent long-term thermal stress.

Short-circuit Protection

If outputs can be shorted either to ground or the supply, use an external circuit to protect the device as shown in the following figure.

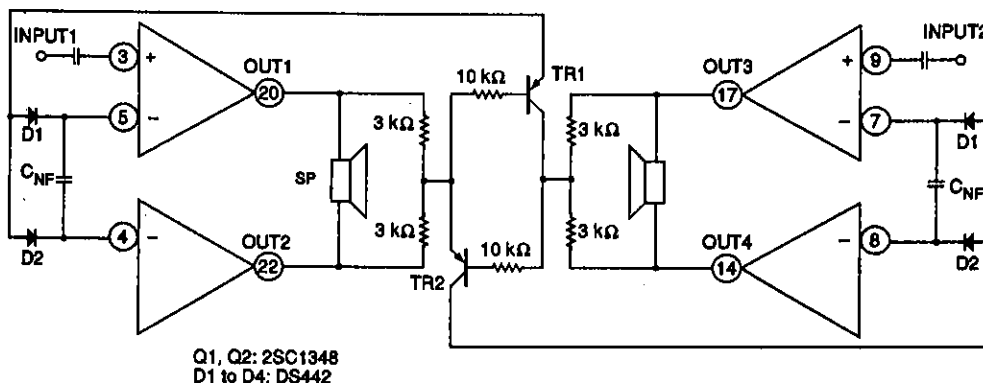

- No products described or contained herein are intended for use in surgical implants, life-support systems, aerospace equipment, nuclear power control systems, vehicles, disaster/crime-prevention equipment and the like, the failure of which may directly or indirectly cause injury, death or property loss.
- Anyone purchasing any products described or contained herein for an above-mentioned use shall:
 - ① Accept full responsibility and indemnify and defend SANYO ELECTRIC CO., LTD., its affiliates, subsidiaries and distributors and all their officers and employees, jointly and severally, against any and all claims and litigation and all damages, cost and expenses associated with such use;
 - ② Not impose any responsibility for any fault or negligence which may be cited in any such claim or litigation on SANYO ELECTRIC CO., LTD., its affiliates, subsidiaries and distributors or any of their officers and employees jointly or severally.
- Information (including circuit diagrams and circuit parameters) herein is for example only; it is not guaranteed for volume production. SANYO believes information herein is accurate and reliable, but no guarantees are made or implied regarding its use or any infringements of intellectual property rights or other rights of third parties.