



LA4590W

1.5 V Stereo Headphone Preamplifier and Power Amplifier

Overview

The LA4590W is a system IC that collects the functions required for a playback set in a single chip, and reduces the number of required external components. Furthermore, a recording system can be formed by combining the LA4590W with the LA3235W.

Functions

- Stereo preamplifier (including functions for auto-reverse, metal/normal tape switching, and muting)
- Stereo power amplifier (including OCL and muting functions)
- Two ripple filters (single channel on/off switching)
- Low boost (BTL operation at low frequencies)
- AMS (inter-station detection function)
- Power switch

Features

- Preamplifier requires no NF capacitors.
- Virtual ground impedance is reduced by built-in V_{REF} amplifier.
- Ripple filter oscillation suppression requires no capacitors.
- Power output available when low boost is on. ($P_o = 21 \text{ mW}$, $V_{CC} = 1.2 \text{ V}$, $f = 100 \text{ Hz}$)
- High cut capacitors built into preamplifier and power amplifier. Buzz suppression
- Miniature package: SQFP-48 (0.5 mm pitch)

Package Dimensions

unit: mm

3163-SQFP48

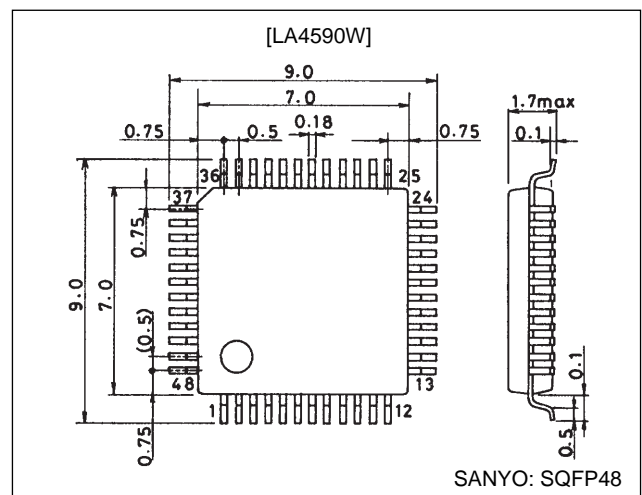

PD max - Ta

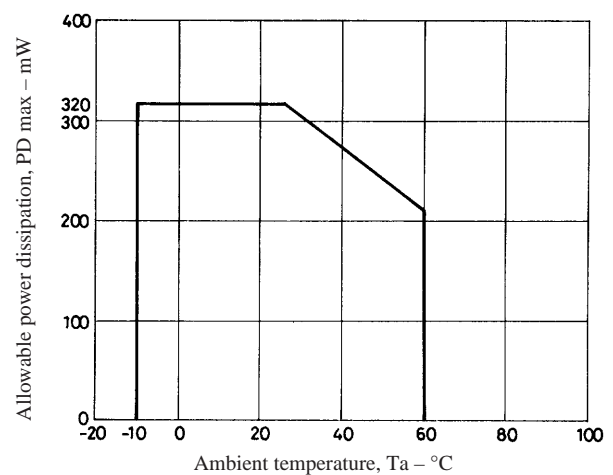

■ Any and all SANYO products described or contained herein do not have specifications that can handle applications that require extremely high levels of reliability, such as life-support systems, aircraft's control systems, or other applications whose failure can be reasonably expected to result in serious physical and/or material damage. Consult with your SANYO representative nearest you before using any SANYO products described or contained herein in such applications.

■ SANYO assumes no responsibility for equipment failures that result from using products at values that exceed, even momentarily, rated values (such as maximum ratings, operating condition ranges, or other parameters) listed in products specifications of any and all SANYO products described or contained herein.

SANYO Electric Co., Ltd. Semiconductor Business Headquarters

TOKYO OFFICE Tokyo Bldg., 1-10, 1 Chome, Ueno, Taito-ku, TOKYO, 110-8534 JAPAN

Specifications

Maximum Ratings at $T_a = 25^\circ\text{C}$

Parameter	Symbol	Conditions	Ratings	Unit
Maximum supply voltage	V_{CC} max		3.0	V
Allowable power dissipation	P_d max		320	mW
Operating temperature	T_{opr}		-10 to +60	$^\circ\text{C}$
Storage temperature	T_{stg}		-40 to +125	$^\circ\text{C}$

Operating Conditions at $T_a = 25^\circ\text{C}$

Parameter	Symbol	Conditions	Ratings	Unit
Recommended supply voltage	V_{CC}		1.5	V
Operating supply voltage range	V_{CC} op		0.95 to 2.2	V

Operating Characteristics

at $T_a = 25^\circ\text{C}$, $V_{CC} = 1.2\text{ V}$, $f = 1\text{ kHz}$, $0.775\text{ V} = 0\text{ dBm}$, $R_L = 10\text{ k}\Omega$ (preamp), $R_L = 16\text{ }\Omega$ (power amplifier)

Parameter	Symbol	Conditions	Ratings			Unit
			min	typ	max	
[Preamplifier + Power Amplifier]						
Quiescent current	I_{CCO1}	$R_g = 2.2\text{ k}\Omega$, $R_V = 0\text{ }\Omega$	8	15	24	mA
	I_{CCO2}	With the power switch off		0.1	5	μA
Voltage gain (closed)	V_{G_T}	$V_O = -20\text{ dBm}$, $R_V = 10\text{ k}\Omega$	54	57	60	dB
[Preamplifier]						
Voltage gain (open)	V_{G_0}	$V_O = -20\text{ dBm}$	60	67		dB
Voltage gain (closed)	V_{G_1}	$V_O = -20\text{ dBm}$	34	35.3	37	dB
	V_{G_2}	$V_O = -20\text{ dBm}$, $f = 10\text{ kHz}$, metal selected	25.5	28	30.5	dB
Maximum output voltage	$V_{O\text{ max}}$	THD = 1%	100	210		mV
Total harmonic distortion	THD_1	$V_G = 35.3\text{ dB/NAB}$, $V_O = 100\text{ mV}$		0.2	0.5	%
Input conversion noise voltage	V_{NI}	$R_g = 2.2\text{ k}\Omega$, BPF: 20 Hz to 20 kHz		1.3	3.0	μV
Crosstalk, inter-channel	CT_1	$R_g = 2.2\text{ k}\Omega$, 1 kHz TUNE, $V_O = -20\text{ dBm}$	45	56		dB
Crosstalk, F/R	CT_2	$R_g = 2.2\text{ k}\Omega$, 1 kHz TUNE, $V_O = -20\text{ dBm}$	65	78		dB
Ripple exclusion ratio	Rr_1	$R_g = 2.2\text{ k}\Omega$, $V_r = -30\text{ dBm}$, $fr = 100\text{ Hz}$ 100 Hz TUNE	45	52		dB
Muted output voltage	V_{M1}	$V_i = -40\text{ dBm}$, 1 kHz TUNE, Muting on			-90	dBm
[Low boost + Power Amplifier]						
Voltage gain (closed)	V_{G_3}	$V_O = -20\text{ dBm}$	20.5	23	25.5	dB
	V_{G_4}	$V_O = -20\text{ dBm}$, L.B. = on	20.5	23	25.5	dB
	V_{G_5}	$V_O = -20\text{ dBm}$, L.B. = on, $f = 10\text{ kHz}$	24.5	27.5	30.5	dB
	V_{G_6}	$V_O = -20\text{ dBm}$, L.B. = on, $f = 100\text{ Hz}$	30	34	38	dB
Output power	P_{O1}	THD = 10%	5	9		mW
	P_{O2}	THD = 10%, $f = 100\text{ Hz}$, L.B. = on	13	21		mW
Total harmonic distortion	THD_2	$P_O = 1\text{ mW}$		0.5	1.5	%
Inter-channel crosstalk	CT_3	$V_O = -20\text{ dBm}$, $R_V = 0\text{ }\Omega$	38	43		dB
Output noise voltage	V_{NO}	$R_V = 0\text{ }\Omega$, BPF: 20 Hz to 20 kHz		35	48	μV
Ripple exclusion ratio	Rr_2	$R_V = 0\text{ }\Omega$, $V_r = -30\text{ dBm}$, $fr = 100\text{ Hz}$, 100 Hz TUNE	50	74		dB
Muted output voltage	V_{M2}	$V_i = -30\text{ dBm}$, 1 kHz TUNE, Muting on			-90	dBm
Input resistance	R_i		8	10	12	$\text{k}\Omega$
Voltage gain difference	ΔV_{G_3}			0	1.5	dB
[Ripple Filter]						
Ripple exclusion ratio	Rr_3	$fr = 100\text{ Hz}$, $V_r = -30\text{ dBm}$, $V_{CC} = 1.0\text{ V}$, $I_{RF} = 25\text{ mA}$, 2SB1295, using a rank 6 h_{FE}	33	39		dB
Output voltage	V_{RF}	$V_{CC} = 1.0\text{ V}$, $I_{RF} = 25\text{ mA}$	0.89	0.93		V
[AMS]						
Operating output voltage	V_{OAMS}	With the Preout output K22 on when the AMS OUT output peak voltage is 0.6 Vp-p.	1.80	2.55	3.6	mV

Note: L.B.: Low boost

LA4590W

Sample Application Circuit

Unit (resistance: Ω, capacitance: F)

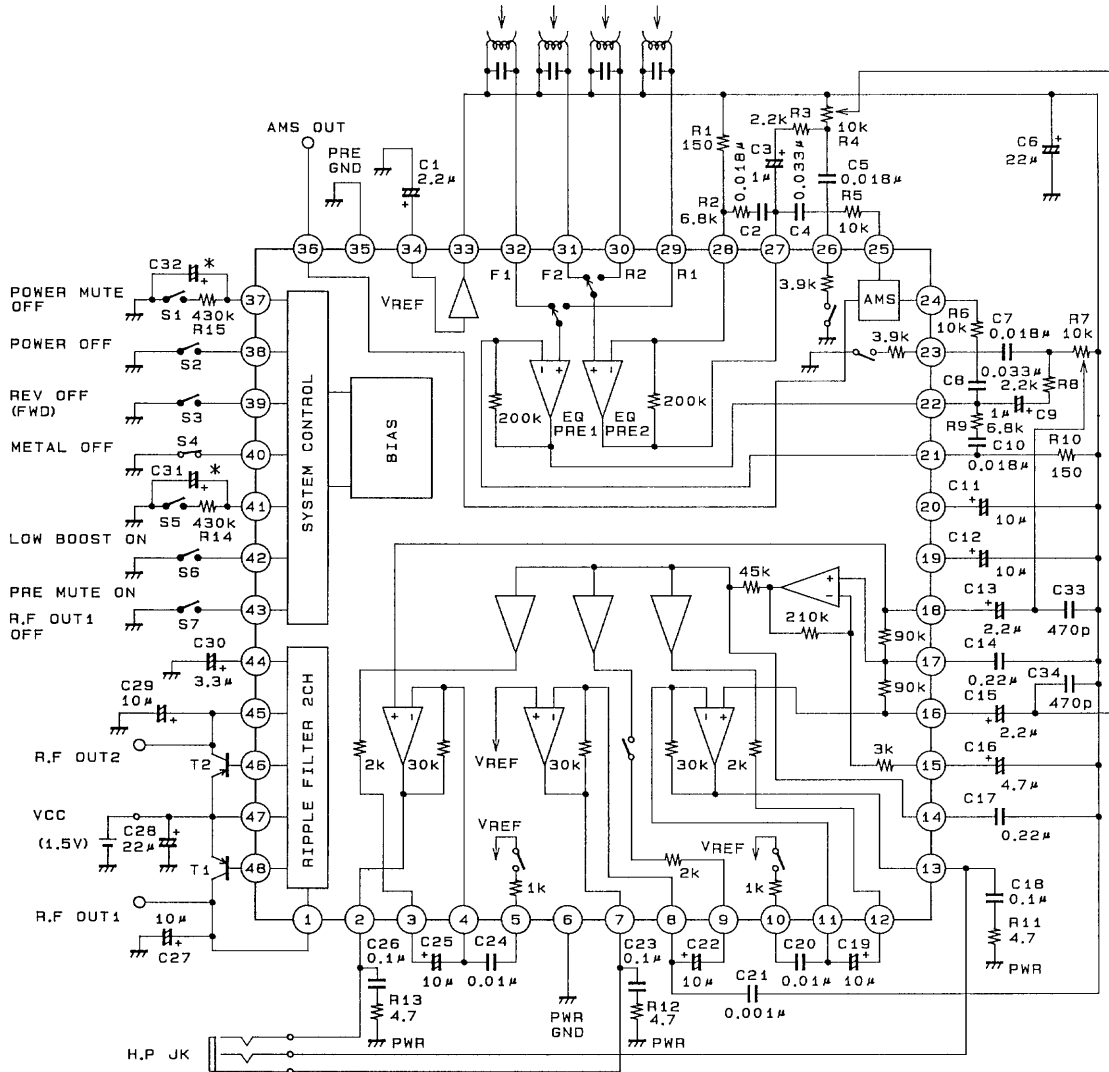

A01291

Note: We recommend using a 2SB1295 of h_{FE} rank 6 or higher as the external transistor.
Capacitors marked with an asterisk must be adjusted according to the set timing. (6800 pF to 0.22 μF)

LA4590W

Pin Functions and Equivalent Circuits ($V_{CC} = 1.2\text{ V}$)

Unit (resistance: Ω , capacitance: F)

Pin No.	Symbol	V_{DC} (V)	Equivalent circuit	Pin function
1 45	R.F OUT 1 R.F OUT 2	1.13		<ul style="list-style-type: none"> R.F OUT1 can be switched on/off: on when pin 43 is at ground.
2 7 13	POWER OUT1 POWER OUTC POWER OUT2	0.6		<ul style="list-style-type: none"> The output spans (pin 2 to pin 7, and pin 13 to pin 7) are connected by 160 Ω resistors.
3 9 12	POWER NF REF1 POWER NF REFC POWER NF REF2	0.75		<ul style="list-style-type: none"> Used as the power NF connections.
4 8 11	POWER NF1 POWER NFC POWER NF2	0.75		<ul style="list-style-type: none"> Power NF pins
5 10	POWER H.P1 POWER H.P2	0.75		<ul style="list-style-type: none"> Connected to V_{ref} through a 1 kΩ resistor when low boost is on, i.e., when pin 41 is floating.
14	L.P2	0.75		<ul style="list-style-type: none"> Low boost secondary low pass pin

Continued on next page.

LA4590W

Continued from preceding page.

Unit (resistance: Ω , capacitance: F)

Pin No.	Symbol	V _{DC} (V)	Equivalent circuit	Pin function
15	LOW BOOST NF	0.75		<ul style="list-style-type: none"> Low boost amplifier NF pins
16 18	POWER IN2 POWER IN1	0.75		<ul style="list-style-type: none"> Power input pins The input resistance is 10 kΩ. Buzz suppression capacitors are built in.
17	L.P1	0.75		<ul style="list-style-type: none"> Low boost primary low pass pin
19 20	NFC2 NFC1	0.75		
21 28	PRE NF1 PRE NF2	0.75		<ul style="list-style-type: none"> Preamplifier NF pins No capacitors are required for these noise filters.
22 27	PRE OUT1 PRE OUT2	0.45		<ul style="list-style-type: none"> Each output pin is connected to the corresponding NF pin by a 200 kΩ resistor.

Continued on next page.

LA4590W

Continued from preceding page.

Unit (resistance: Ω , capacitance: F)

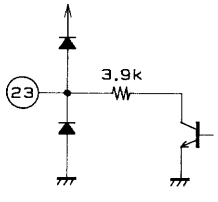
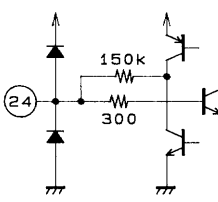
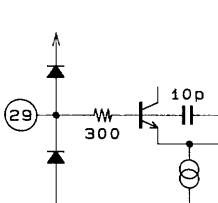
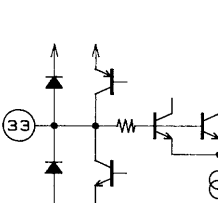
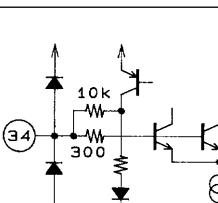
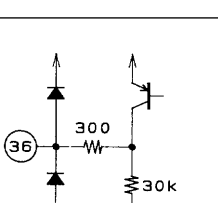
Pin No.	Symbol	V _{DC} (V)	Equivalent circuit	Pin function
23 26	METAL1 METAL2	0	 <p style="text-align: right;">A00395</p>	<ul style="list-style-type: none"> Connected to ground by a 3.9 kΩ resistor when metal is selected (pin 40 is floating).
24 25	AMS IN1 AMS IN2	0.75	 <p style="text-align: right;">A00396</p>	<ul style="list-style-type: none"> AMS inverting input pins External input resistors must be connected to these pins.
29 30 31 32	PRE REV IN1 PRE REV IN2 PRE FWD IN2 PRE FWD IN1	0.75	 <p style="text-align: right;">A00397</p>	<ul style="list-style-type: none"> Pins 29 and 30 are on in reverse mode (when pin 39 is grounded). Pins 31 and 32 are on in forward mode (when pin 39 is floating). When a particular head is not used, 2.2 kΩ bias resistors must be inserted between the corresponding pins and V_{ref} (pin 33). Buzz suppression capacitors are built-in.
33	V _{REF}	0.75	 <p style="text-align: right;">A00398</p>	<ul style="list-style-type: none"> V_{REF} amplifier output pin. A built-in output resistor (r_o, about 10 Ω) makes this a low impedance output. The current (inflow and outflow) capacity of this pin is 200 μA, maximum.
34	REF	0.75	 <p style="text-align: right;">A00399</p>	<ul style="list-style-type: none"> V_{REF} amplifier reference
36	AMS OUT		 <p style="text-align: right;">A00400</p>	<ul style="list-style-type: none"> Outputs a pulse waveform that depends on the AMS IN (pins 24 and 25) input levels.

Continued on next page.

LA4590W

Continued from preceding page.

Unit (resistance: Ω , capacitance: F)

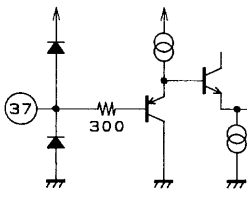
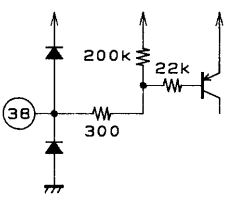
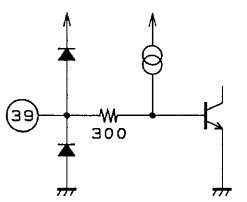
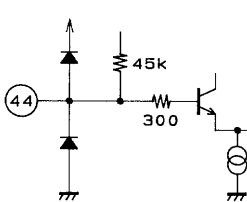
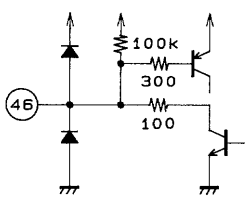
Pin No.	Symbol	V_{DC} (V)	Equivalent circuit	Pin function
37 41	POWER MUTE SW LOW BOOST SW		 <p style="text-align: right;">A00401</p>	<ul style="list-style-type: none"> Muting is turned on by grounding pin 37. Low boost is turned on by setting pin 41 floating.
38	POWER SW		 <p style="text-align: right;">A00402</p>	<ul style="list-style-type: none"> Turns on IC power when grounded.
39 40 42 43	FWD/REV SW METAL SW PRE MUTE SW R.F1 SW		 <p style="text-align: right;">A01292</p>	<ul style="list-style-type: none"> Forward is selected when pin 39 is floating, reverse when grounded. Metal is selected when pin 40 is floating. Muting is turned on when pin 42 is floating. R.F1 (pin 1) is turned on when pin 43 is grounded.
44	R.F REF	1.13	 <p style="text-align: right;">A00404</p>	<ul style="list-style-type: none"> The R.F. reference. The R.F. SVRR can be changed with an external capacitor.
46 48	R.F BASE2 R.F BASE1	0.5	 <p style="text-align: right;">A00405</p>	<ul style="list-style-type: none"> External PNP transistor base drive pins.

External Component Functions: Recommended values are indicated in parentheses.

- C₁ (1.0 to 10 μ F)

V_{REF} amplifier reference decoupling capacitor

This capacitor changes the VREF SVRR. Note that the SVRR is degraded as this capacitance decreases.

- C₂, C₁₀

Playback equalization constants

- C₃, C₉ (0.47 to 3.3 μ F)

Preamplifier output capacitors

- C₄, C₈

AMS input high pass filter capacitors

- C₅, C₇

Metal tape equalization constants. (The internal resistance is 3.9 k Ω \pm 15%.)

- C₆ (0.1 to 22 μ F)

V_{REF} decoupling capacitor

Used for excluding high frequency noise.

- C₁₁, C₁₂ (3.3 to 10 μ F)

NFC decoupling capacitors

Note that the preamplifier low frequency gain falls as these capacitances are reduced.

- C₁₃, C₁₅ (1.0 to 3.3 μ F)

Power amplifier input capacitors (Input resistance: 10 k Ω)

- C₁₄, C₁₇

Low boost low pass filter capacitors

The low boost gain can be changed by varying these capacitances.

- C₁₆ (1.0 to 4.7 μ F)

Boost amplifier NF capacitor

Note that the low boost low frequency gain falls as these capacitances are reduced.

- C₁₈, C₂₃, C₂₆ (0.1 to 1.0 μ F)

Oscillation suppression capacitors

- C₁₉, C₂₂, C₂₅ (3.3 to 10 μ F)

Power amplifier NF capacitors

Note that the power amplifier low frequency gain falls as these capacitances are reduced.

- C₂₀, C₂₄

Loudness high boost capacitors

The high frequency gain is changed by these capacitances.

- C₂₁ (100 to 2200 pF)

Oscillation suppression capacitor

- C₂₇, C₂₉ (4.7 to 10 μ F)

R.F. output decoupling capacitors (These capacitors also function as power supply capacitors and oscillation suppression capacitors.)

- C₂₈ (22 to 220 μ F)

Power supply capacitors

- C₃₀ (2.2 to 10 μ F)

R.F. reference low pass filter capacitor

The R.F. SVRR is changed by this capacitance.

- C₃₁, C₃₂ (6800 pF to 0.22 μ F)

Switching circuit smoothing capacitors. These capacitances must be adjusted according to the set timing.

- C₃₃, C₃₄ (470 to 1000 pF)

Oscillation suppression capacitors used when both the preamplifier and power amplifier are used, i.e., when the volume is maximum.

- R₁, R₁₀

Preamplifier gain adjustment

- R₂, R₉

Playback equalization constants

- R₃, R₈

Metal tape equalization constants

- R₄, R₇

10 k Ω variable resistors

- R₅, R₆

AMS gain adjustment and high pass filter

- R₁₁, R₁₂, R₁₃

Oscillation suppression

- R₁₄, R₁₅ (100 to 430 k Ω)

Switching circuit smoothing (discharge resistors)

Function Descriptions

1. Low boost system

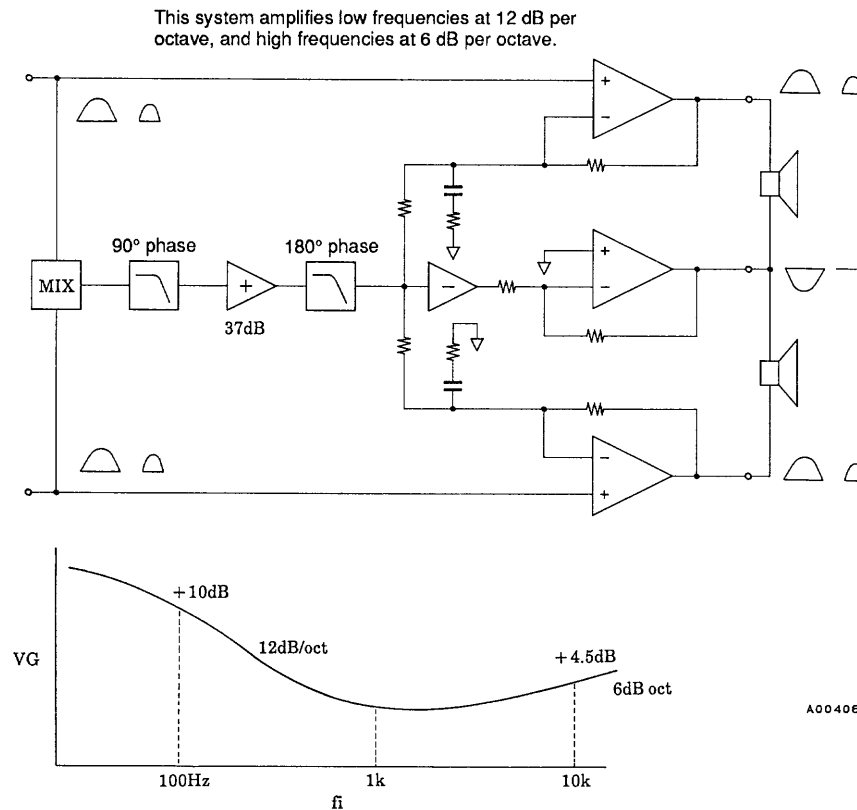

2. Low boost

The signals applied to each input are mixed and passed through a two stage low pass filter. Since the signal level is reduced by the low pass filters it is amplified between the two low pass filter stages to correct the level. The signal that has passed through the second low pass filter is reversed in phase with respect to the input signal and is input to each power amplifier.

3. Channel 1 and 2 amplifiers

The positive phase input signals are input to the normal (+) inputs, and the reverse phase signal that was passed through the low pass filter is input to the inverting (-) inputs.

4. Common amplifier

The signal that was passed through the low pass filter is phase inverted by an inverting amplifier and input to the common amplifier's inverting (-) input. Note that this input signal is reverse phase from the signal input to the channel 1 and channel 2 amplifier inverting (-) inputs. Since the amplifier's plus input is connected to Vref, it functions as an inverting amplifier.

This circuit achieves a large dynamic range since the common amplifier and the channel 1 and channel 2 amplifiers operate in reverse phases.

Low Boost Switching Application Circuit Proposals

Proposal 1

Unit (resistance: Ω , capacitance: F)

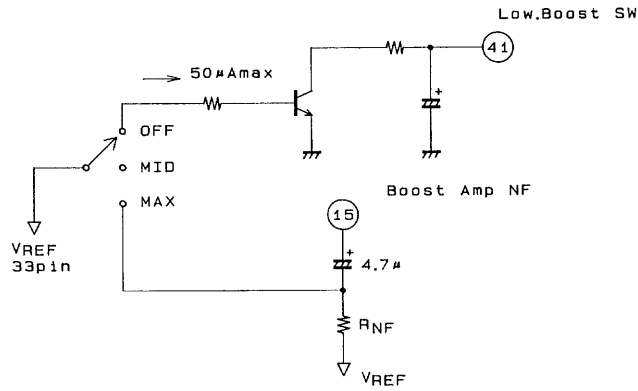

A00407

Proposal 2

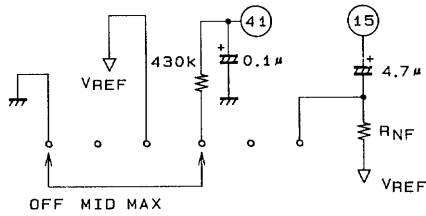

A00408

The above circuits both achieve middle and maximum settings by changing the boost amplifier gain.

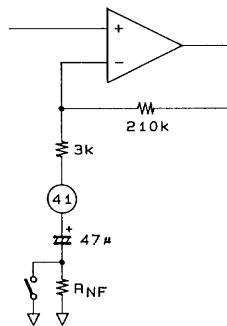

A00409

AMS Comparator

Block Diagram

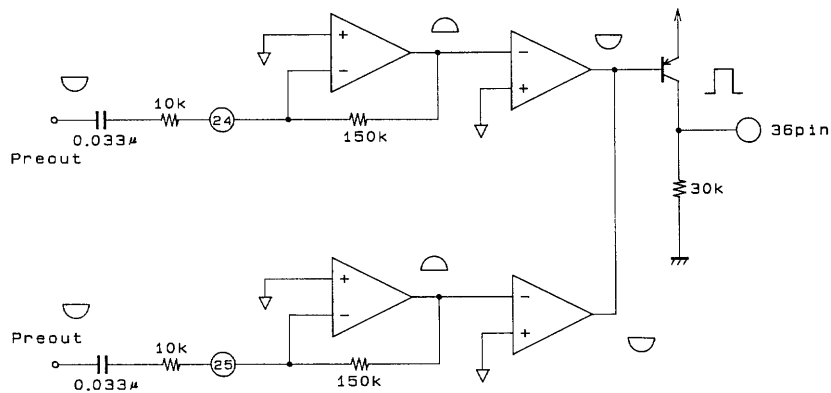

A00410

Function Descriptions

1. The input amplifier has an inverting structure. The gain and the high pass filter characteristics are adjusted by an external CR circuit that determines the input impedance.
2. The AMS comparator outputs pulses for input waveforms that fulfill certain conditions (frequency and voltage level).

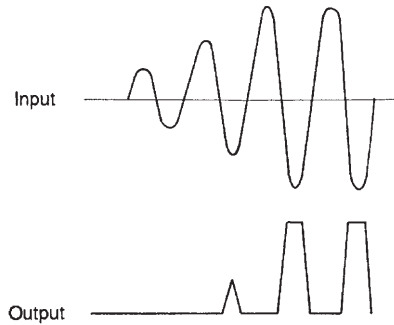

3. Connect pins 24 and 25 to Vref (pin 33) if the AMS function is not used.

Ripple Filter

1. The ripple filter SVRR is adjusted with the external capacitor connected at pin 44.

3.3 μF \rightarrow 39 dB

4.7 μF \rightarrow 42 dB

10 μF \rightarrow 47 dB

2. Leave pins 43, 48 and 1 floating if ripple filter 1 is not used.
3. We recommend using a 2SB1295 of rank 6 or higher as the external transistor.

Power Output

1. The power amplifier and common amplifier outputs are connected by resistances of about 160 Ω .

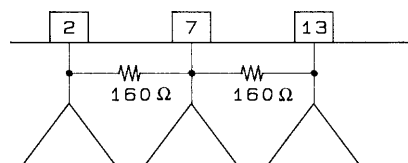

A00411

Power Muting

1. The power muting function turns off the fixed current supplied to the power block.
2. The output DC voltage when the power muting function is on is the Vref potential (0.75 V).
3. The output impedance when the power muting function is on is about 10 k Ω .

Preamplifier Muting

1. The preamplifier muting function turns off the fixed current supplied to the preamplifier block.
2. The output DC voltage when the preamplifier muting function is on is the Vref potential (0.75 V).
3. The output impedance when the preamplifier muting function is on is determined by the NAB constants.

Switch Pin Equivalent Circuits

1. Power switch pin

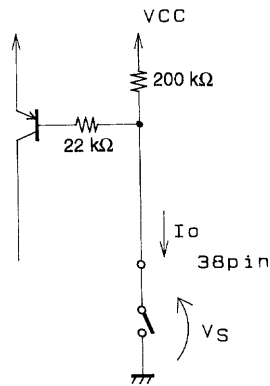

The power switch is on when the power switch pin is connected to ground.

$$I_o = V_{CC}/200 \text{ k} + V_{CC} - 0.7 \text{ V}/22 \text{ k}\Omega$$

Pin 38

$$V_S \leq 100 \text{ mV}$$

A00412

2. Power muting and low boost switch pins

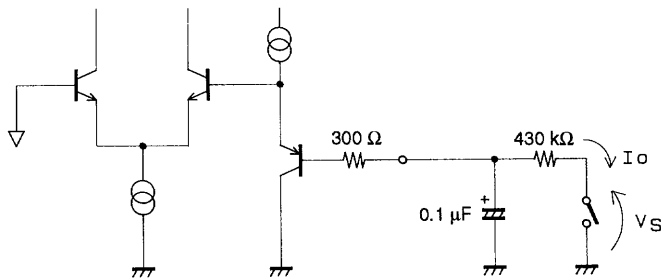

The power muting function is turned on when pin 37 is connected to ground.

The low boost switch is turned on when pin 41 is floating.

$$I_o \leq 0.1 \mu\text{A}$$

$$V_S \leq 80 \text{ mV}$$

Note: The smoothing discharge resistor should be 430 kΩ or smaller.

3. FWD/REV, METAL, PRE MUTE, R.F1 switches

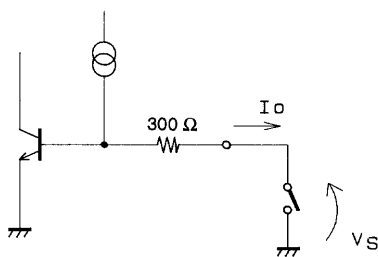

Reverse is selected when pin 39 is connected to ground.

Metal tape is selected when pin 40 is floating.

Pre-amplifier muting is turned on when pin 42 is floating.

The ripple filter switch is turned on when pin 43 is grounded.

$$\left\{ \begin{array}{l} \text{Pins 39, 40, and 43} \\ I_o \leq 7 \mu\text{A} \\ V_S \leq 0.5 \text{ V} \end{array} \right\} \left\{ \begin{array}{l} \text{Pin 42} \\ I_o \leq 14 \mu\text{A} \\ V_S \leq 0.5 \text{ V} \end{array} \right.$$

A00414

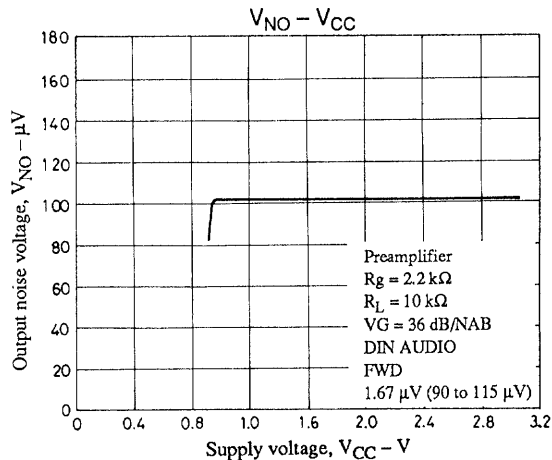
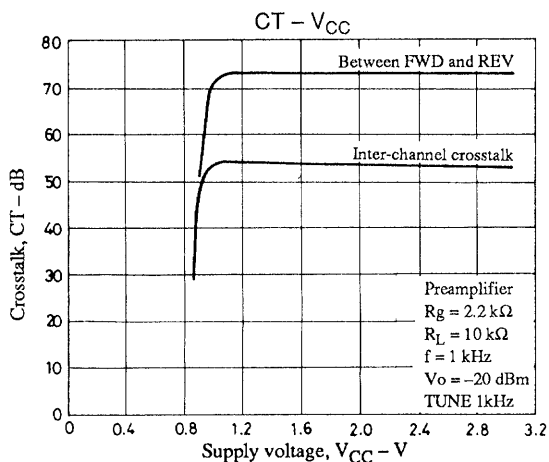
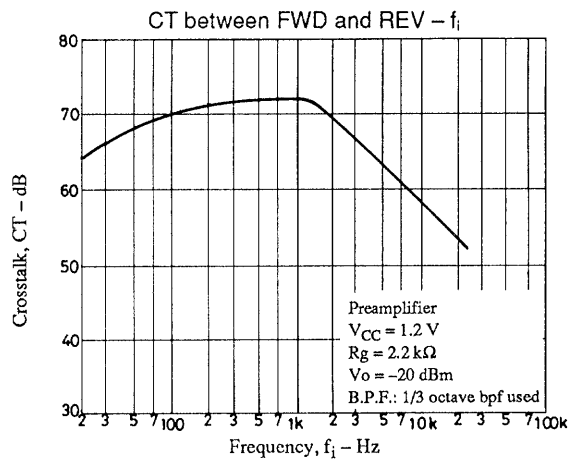
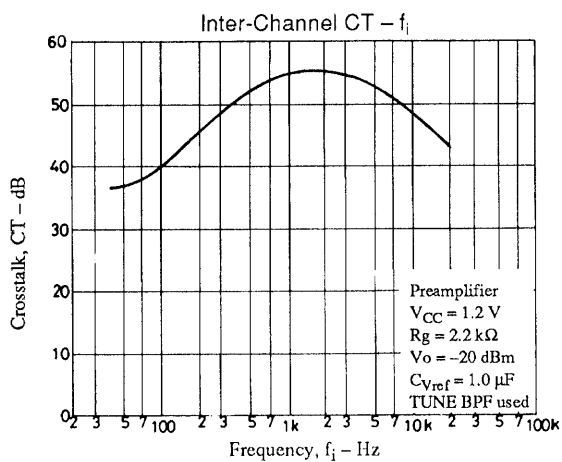
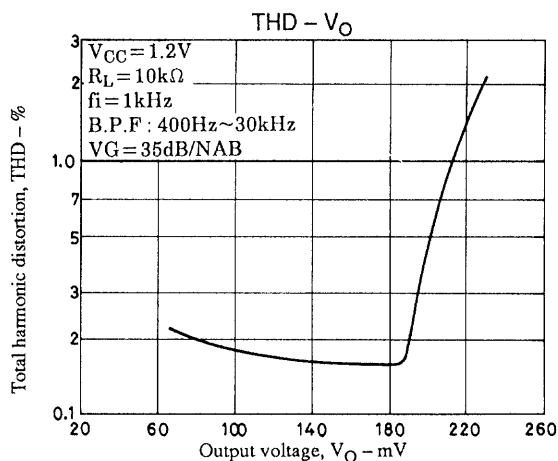
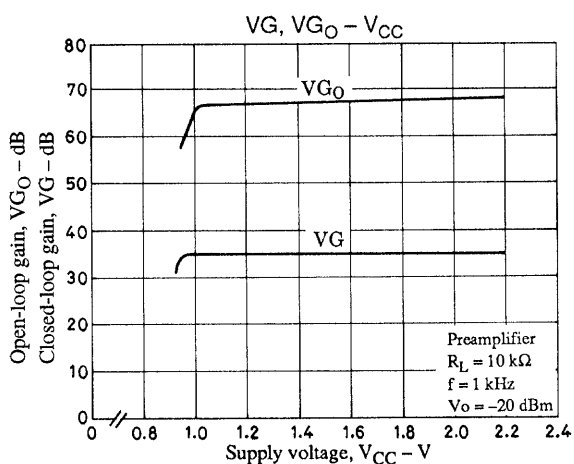
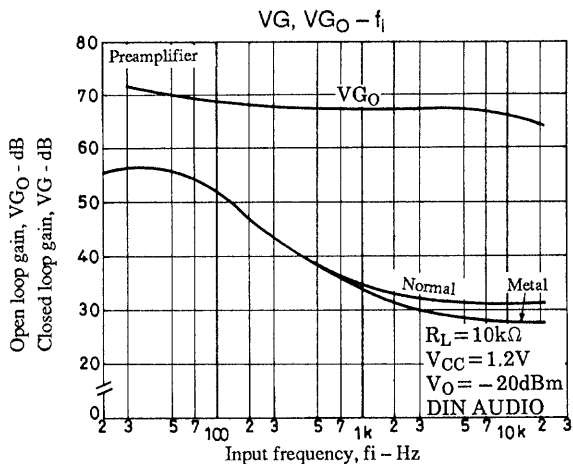
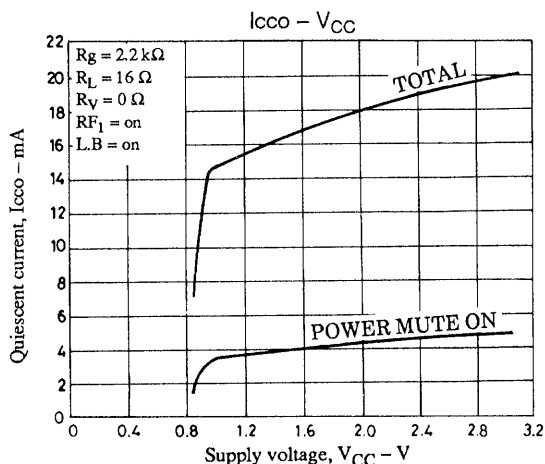

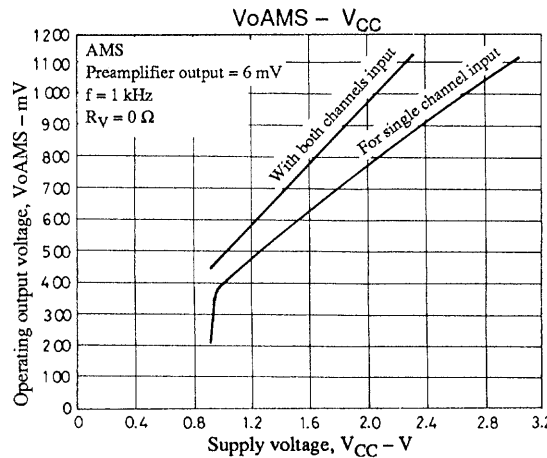
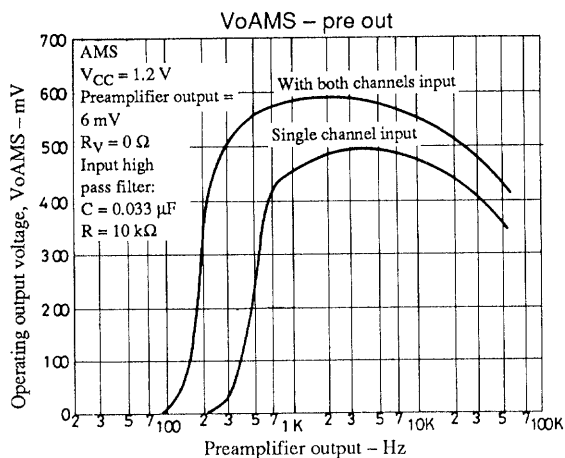
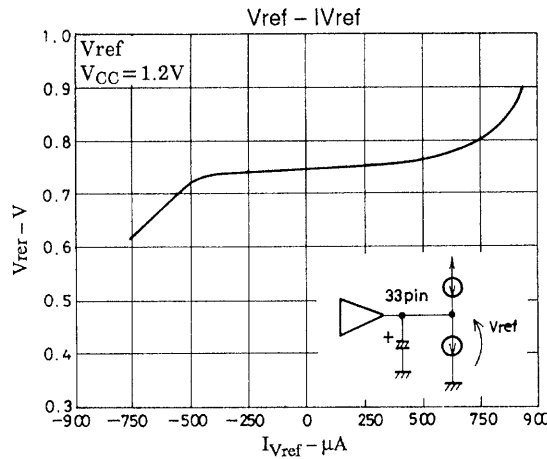
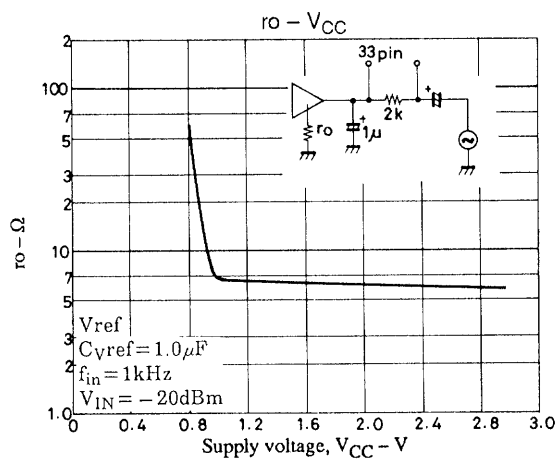
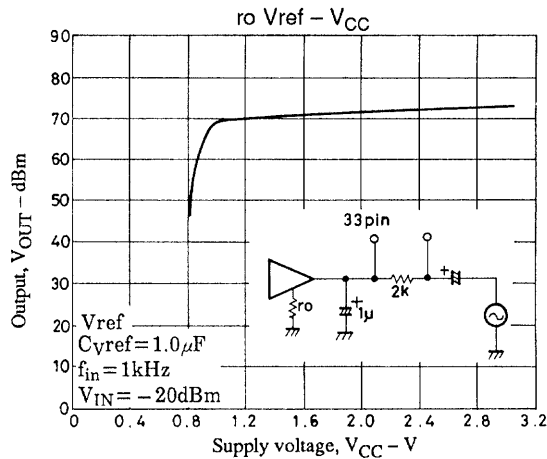
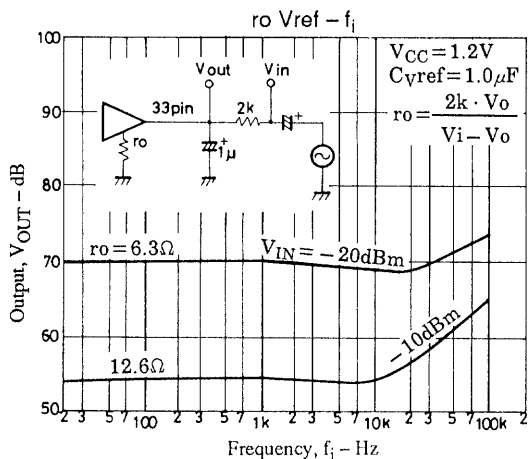
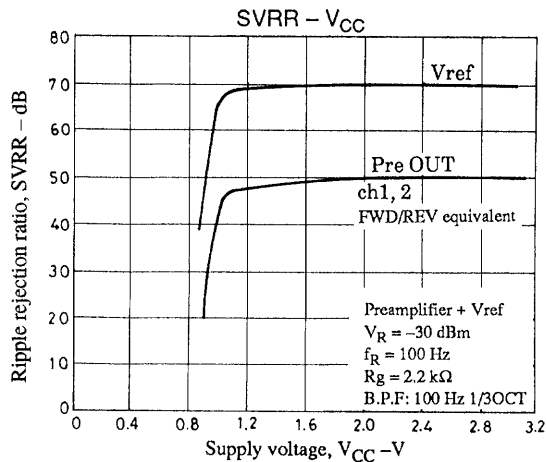
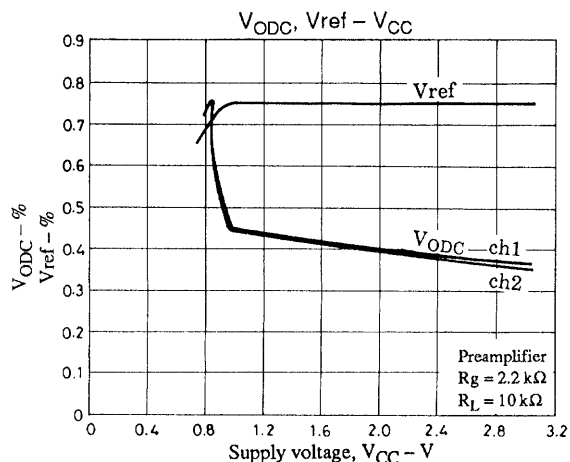

Unit (resistance: Ω , capacitance: F)

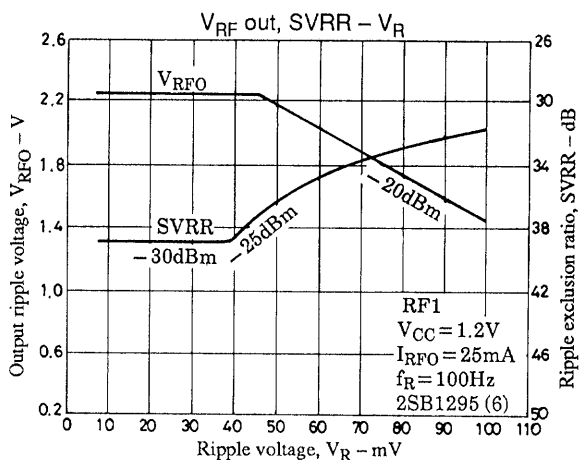
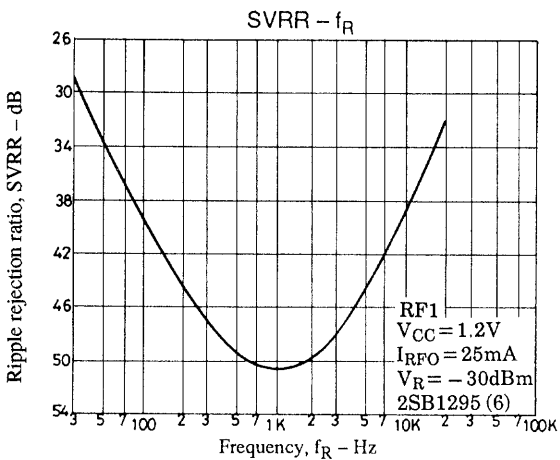
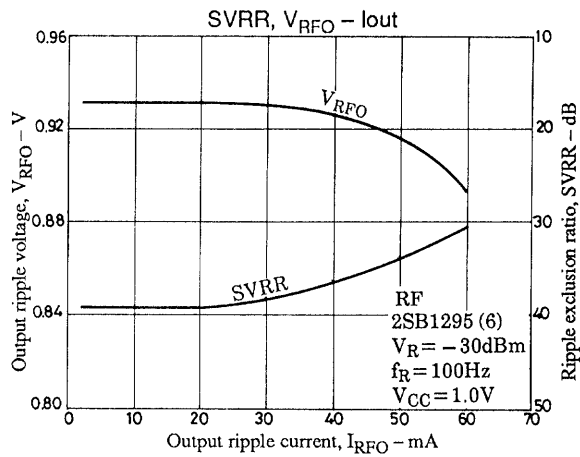
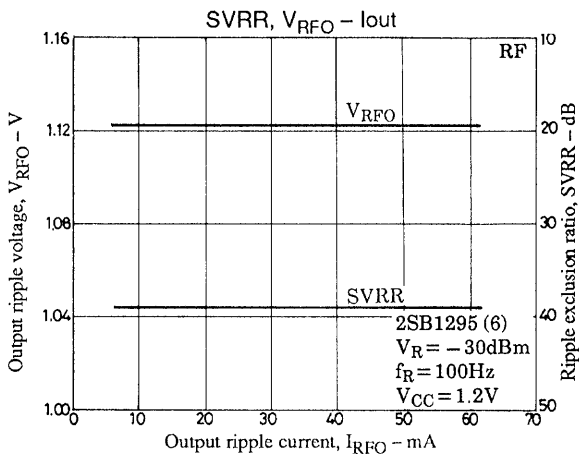
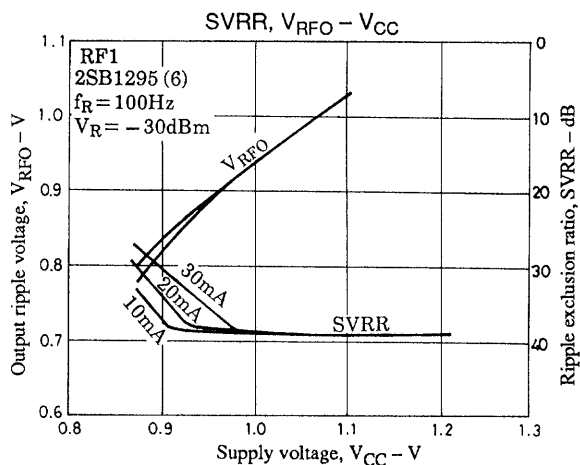
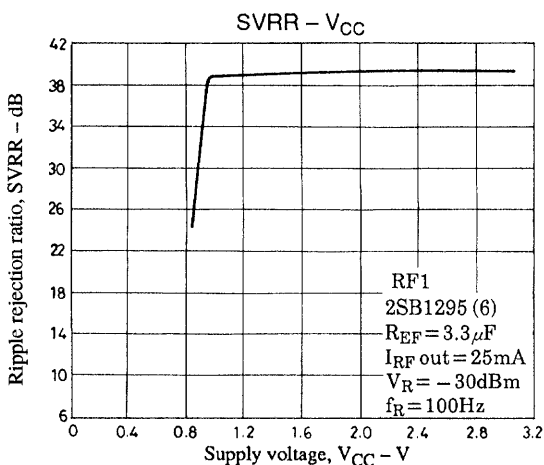
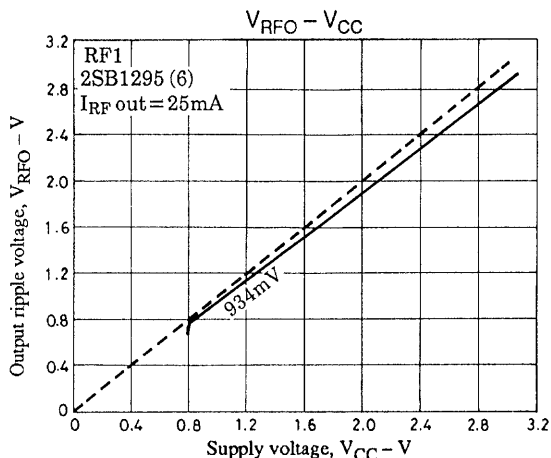
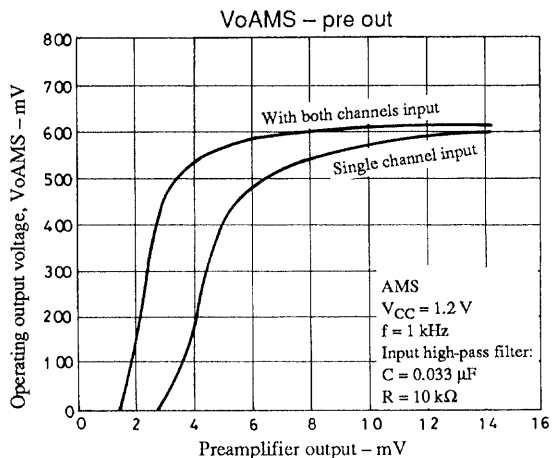

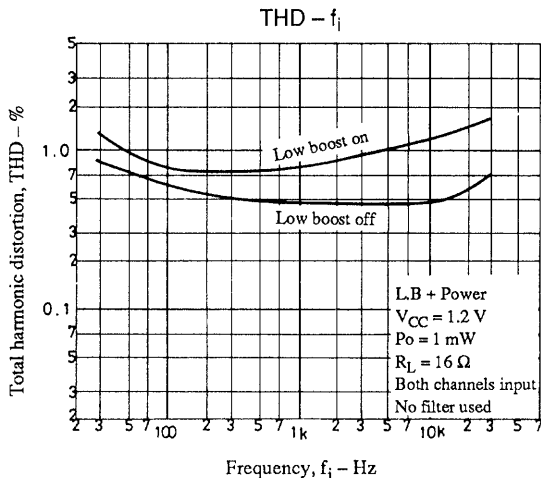
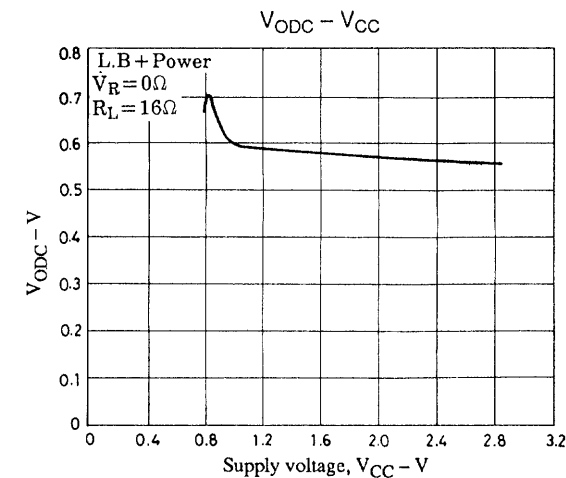
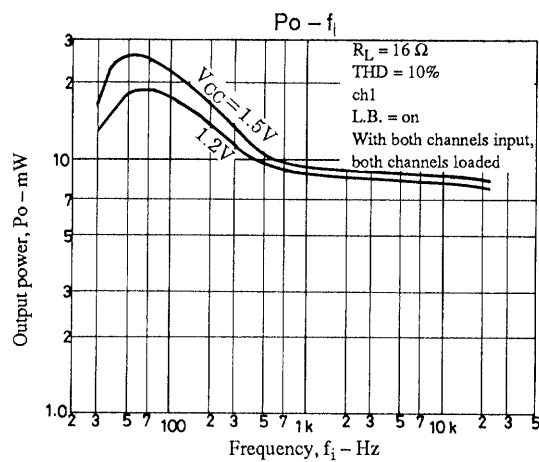
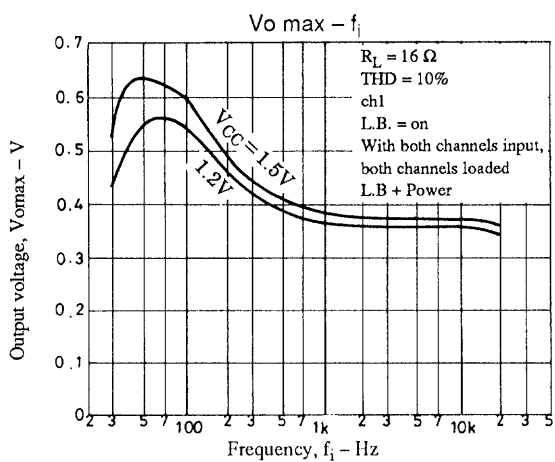
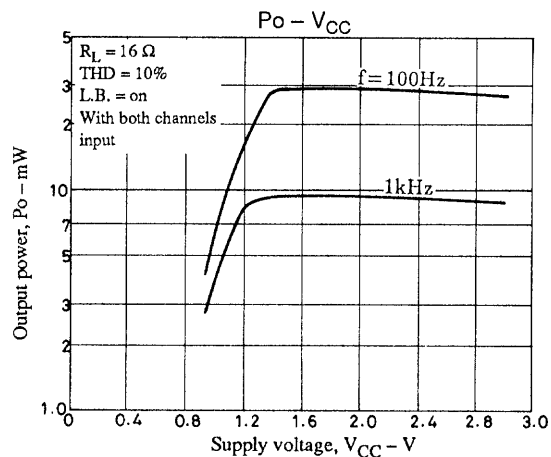
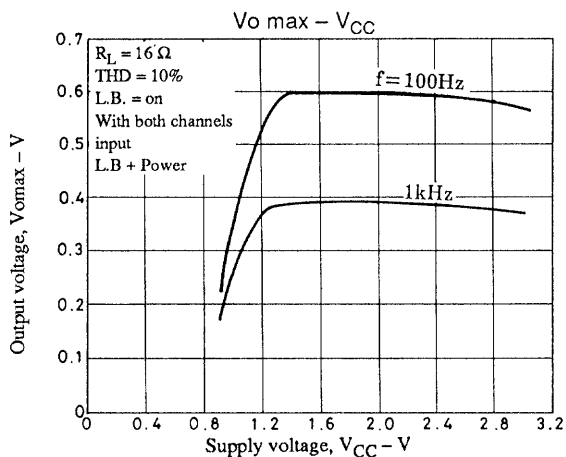
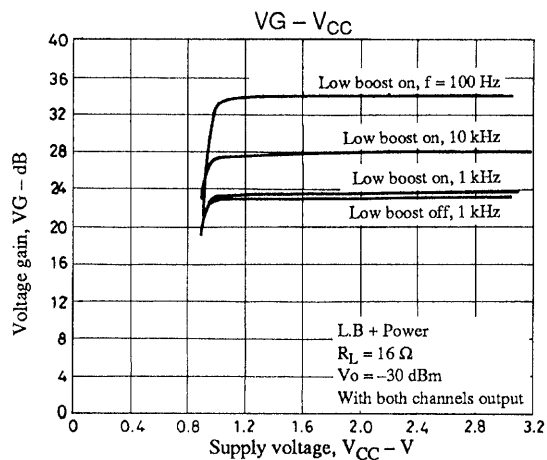
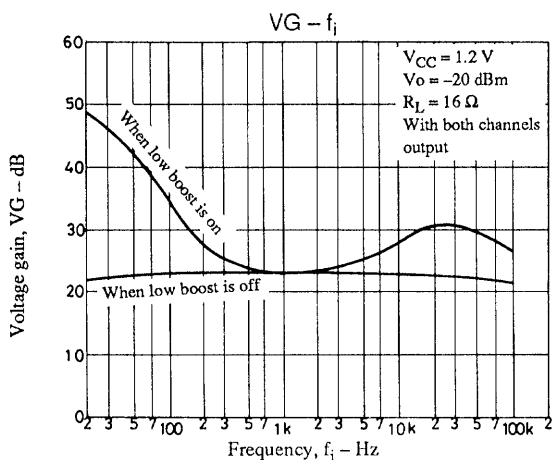

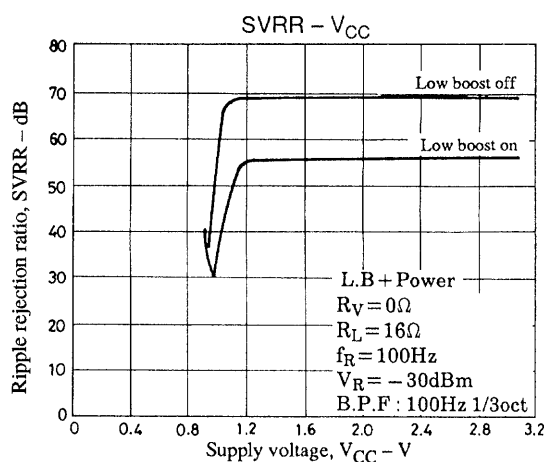
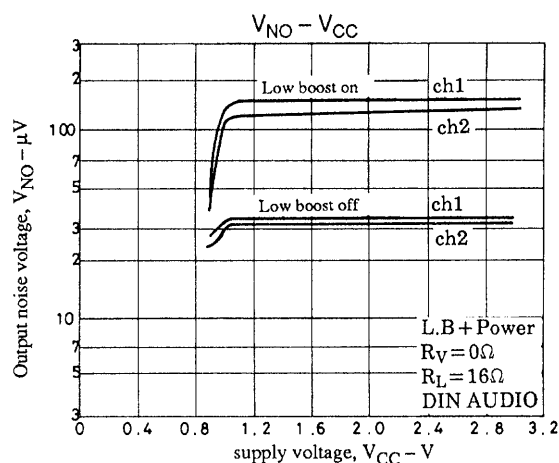
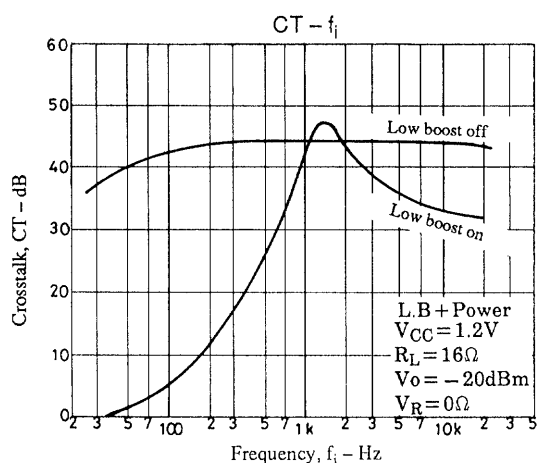

- Specifications of any and all SANYO products described or contained herein stipulate the performance, characteristics, and functions of the described products in the independent state, and are not guarantees of the performance, characteristics, and functions of the described products as mounted in the customer's products or equipment. To verify symptoms and states that cannot be evaluated in an independent device, the customer should always evaluate and test devices mounted in the customer's products or equipment.
- SANYO Electric Co., Ltd. strives to supply high-quality high-reliability products. However, any and all semiconductor products fail with some probability. It is possible that these probabilistic failures could give rise to accidents or events that could endanger human lives, that could give rise to smoke or fire, or that could cause damage to other property. When designing equipment, adopt safety measures so that these kinds of accidents or events cannot occur. Such measures include but are not limited to protective circuits and error prevention circuits for safe design, redundant design, and structural design.
- In the event that any or all SANYO products (including technical data, services) described or contained herein are controlled under any of applicable local export control laws and regulations, such products must not be exported without obtaining the export license from the authorities concerned in accordance with the above law.
- No part of this publication may be reproduced or transmitted in any form or by any means, electronic or mechanical, including photocopying and recording, or any information storage or retrieval system, or otherwise, without the prior written permission of SANYO Electric Co., Ltd.
- Any and all information described or contained herein are subject to change without notice due to product/technology improvement, etc. When designing equipment, refer to the "Delivery Specification" for the SANYO product that you intend to use.
- Information (including circuit diagrams and circuit parameters) herein is for example only; it is not guaranteed for volume production. SANYO believes information herein is accurate and reliable, but no guarantees are made or implied regarding its use or any infringements of intellectual property rights or other rights of third parties.

This catalog provides information as of December, 1998. Specifications and information herein are subject to change without notice.