



# LA4534M

## 3V CD Headphone-stereo Power Amplifier

The LA4534M is a low noise, low distortion headphone-stereo power IC designed for use in a portable CD.

### Features

- Less current drain.
- Accept 16Ω load drive.
- Excellent voltage reduction characteristic.
- Excellent ripple rejection.
- Power switch function and built-in muting circuit.
- Low noise (7μV), low gain (11dB).

### Package Dimensions

unit:mm

#### 3086A-MFP10S

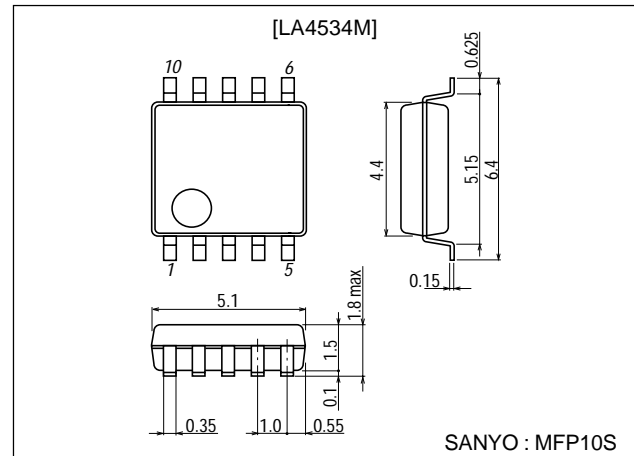

### Specifications

#### Absolute Maximum Ratings at Ta = 25°C

Parameter	Symbol	Conditions	Ratings	Unit
Maximum supply voltage	V <sub>CC</sub> max	Quiescent time	4.5	V
Allowable power dissipation	P <sub>d</sub> max		300	mW
Operating temperature	T <sub>opr</sub>		-20 to +75	°C
Storage temperature	T <sub>stg</sub>		-40 to +125	°C

#### Operating Conditions at Ta = 25°C

Parameter	Symbol	Conditions	Ratings	Unit
Recommended supply voltage	V <sub>CC</sub>		3.0	V
Operating supply voltage range	V <sub>CC op</sub>		1.6 to 4.0	V
Recommended load impedance	R <sub>L</sub>		16 to 32	Ω

■ Any and all SANYO products described or contained herein do not have specifications that can handle applications that require extremely high levels of reliability, such as life-support systems, aircraft's control systems, or other applications whose failure can be reasonably expected to result in serious physical and/or material damage. Consult with your SANYO representative nearest you before using any SANYO products described or contained herein in such applications.

■ SANYO assumes no responsibility for equipment failures that result from using products at values that exceed, even momentarily, rated values (such as maximum ratings, operating condition ranges, or other parameters) listed in products specifications of any and all SANYO products described or contained herein.

**SANYO Electric Co.,Ltd. Semiconductor Business Headquarters**

TOKYO OFFICE Tokyo Bldg., 1-10, 1 Chome, Ueno, Taito-ku, TOKYO, 110-8534 JAPAN

# LA4534M

## Operating Characteristics at $T_a = 25^\circ\text{C}$ , $R_L=16\Omega$ , $R_g=600\Omega$

Parameter	Symbol	Conditions	Ratings			Unit
			min	typ	max	
Quiescent current	$I_{CCO1}$	$V_{CC}=2.4\text{V}$ , Quiescent time		5.4	10	mA
	$I_{CCO2}$	$V_{CC}=4.5\text{V}$ , pin 10 to GND		1.1	2.0	mA
	$I_{CCO3}$	$V_{CC}=4.5\text{V}$ , pin 1 to GND			1.0	$\mu\text{A}$
Voltage gain	VG1	$V_{CC}=2.4\text{V}$ , $f=1\text{kHz}$ , $V_O=-10\text{dBm}$	9	11	13	dB
	VG2	$V_{CC}=1.6\text{V}$ , $f=1\text{kHz}$ , $V_O=-20\text{dBm}$	9	11	13	dB
Voltage gain variations	$\Delta\text{VG1}$	$V_{CC}=2.4\text{V}$ , $f=1\text{kHz}$ , $V_O=-10\text{dBm}$			1.0	dB
	$\Delta\text{VG2}$	$V_{CC}=1.6\text{V}$ , $f=1\text{kHz}$ , $V_O=-20\text{dBm}$			1.0	dB
Total harmonic distortion	THD	$V_{CC}=2.0\text{V}$ , $f=1\text{kHz}$ , $P_O=1\text{mW}$		0.08	0.24	%
Output power	$P_O$	$V_{CC}=3.0\text{V}$ , $f=1\text{kHz}$ , THD=10%	25	50		mW
Crosstalk	CT	$V_{CC}=2.4\text{V}$ , $f=1\text{kHz}$ , $R_g=1\text{k}\Omega$ , $V_O=-10\text{dBm}$	40	50		mW
Ripple rejection	SVRR	$V_{CC}=1.6\text{V}$ , $f=100\text{Hz}$ , $R_g=1\text{k}\Omega$ , $V_R=-20\text{dBm}$ , BPF=100Hz	50	70		dB
Output noise voltage	$V_{NO}$	$V_{CC}=4.5\text{V}$ , $R_g=1\text{k}\Omega$ , BPF=20Hz to 20kHz		7	20	$\mu\text{V}$
Power off effect	$V_{O(\text{off})}$	$V_{CC}=1.6\text{V}$ , $f=100\text{Hz}$ , Pin 1 to GND, $V_{IN}=-10\text{dBm}$			-80	dBm
Mute effect	$V_{O(\text{MT})}$	$V_{CC}=1.6\text{V}$ , $f=100\text{Hz}$ , Pin 10 to GND, $V_{IN}=-10\text{dBm}$			-80	dBm
Power on current sensitivity	$I1(\text{on})$	$V_{CC}=1.5\text{V}$ , $V_5 \geq 0.85\text{V}$		0.05	1.0	$\mu\text{A}$
Power off voltage sensitivity	$V1(\text{off})$	$V_{CC}=1.5\text{V}$ , $V_5 \leq 0.1\text{V}$	0.5	0.6		V
Mute off current sensitivity	$I10(\text{off})$	$V_{CC}=1.5\text{V}$ , $V_5 \geq 0.85\text{V}$		0.2	1.0	$\mu\text{A}$
Mute on voltage sensitivity	$V10(\text{on})$	$V_{CC}=1.5\text{V}$ , $V_5 \leq 0.1\text{V}$	0.5	0.65		V

Note : Quiescent current is the current flowing into pin 6. The current flowing into pin 1 and pin 10 is at the maximum value and calculated from the equation  $(V_{\text{pin}}-0.5\text{V})/16[\text{V}/\text{k}\Omega]$ , increasing total current.

## Equivalent Circuit Block Diagram

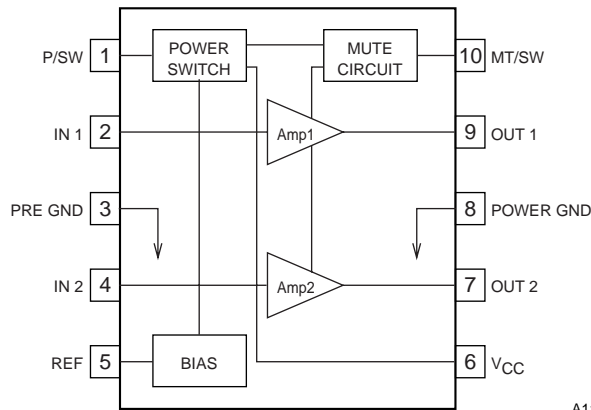

A11151

# LA4534M

## Test Circuit

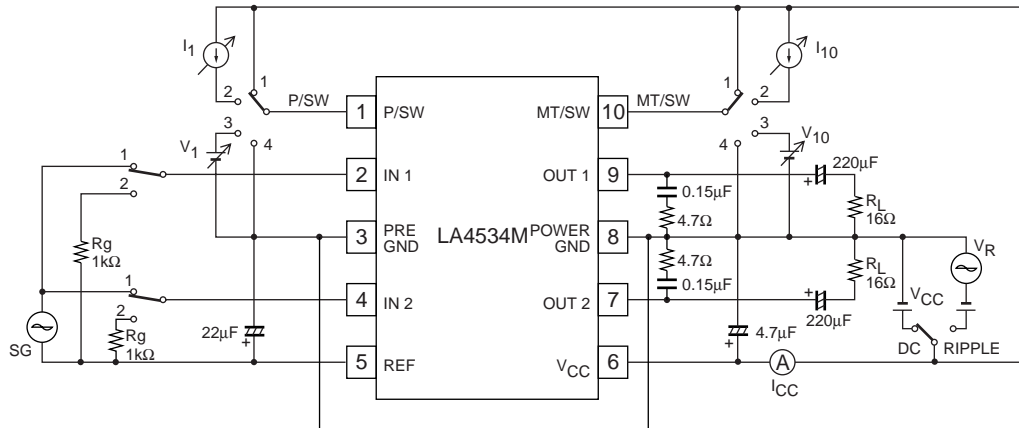

A11152

## Sample Application Circuit

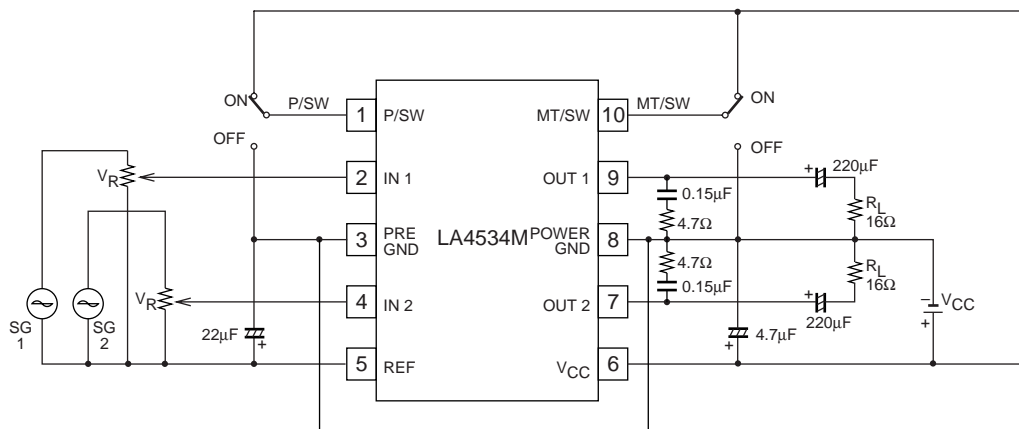

A11153

# LA4534M

## Pin Functions ( $V_{CC}=3.0V$ )

Pin No.	Symbol	Pin voltage (V)	Equivalent circuit	Pin function
1	P/SW1			<ul style="list-style-type: none"> <li>The system turns on when the <math>V_{CC}</math> is applied to this pin and turns off by connecting this pin to GND.</li> </ul>
2 4	IN1 IN2	1.1 1.1		<ul style="list-style-type: none"> <li>Input pin connection. Input impedance is 10kΩ.</li> </ul>
3	PRE GND			
5	REF	1.1		<ul style="list-style-type: none"> <li>1.1V fixed bias is applied to this pin.</li> </ul>
6	$V_{CC}$	3.0		
7 9	OUT2 OUT1	1.1 1.1		<ul style="list-style-type: none"> <li>Output pin connection.</li> </ul>
8	POWER GND			
10	MT/SW			<ul style="list-style-type: none"> <li>The muting function turns on when this pin is connected to GND and turns off by applying the <math>V_{CC}</math> to this pin.</li> </ul>

# LA4534M

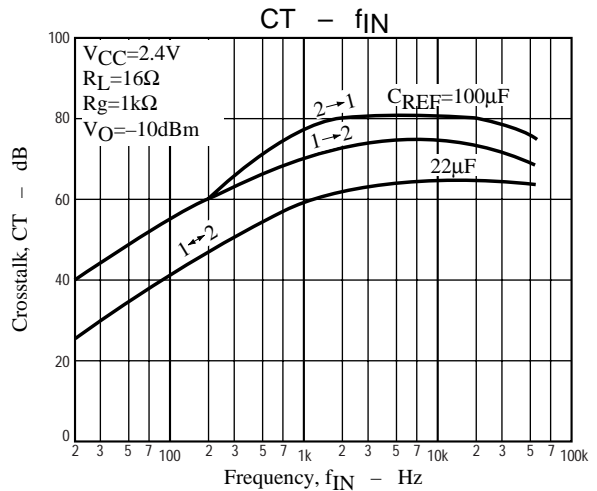
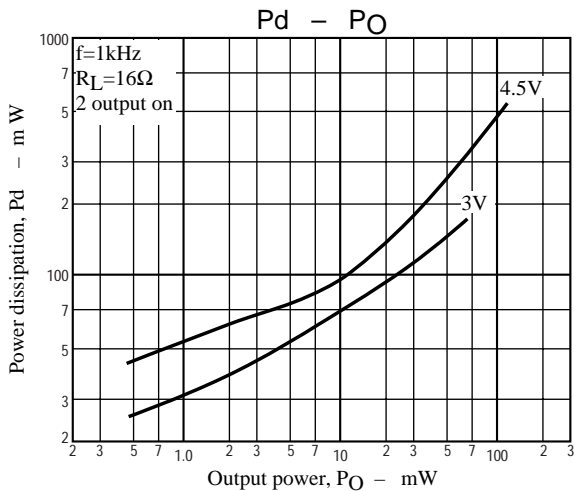
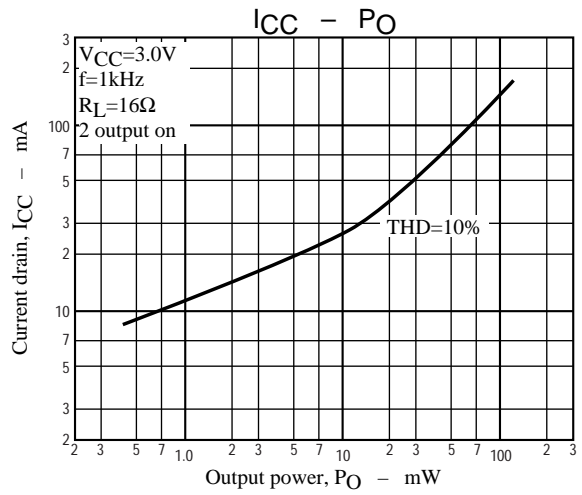
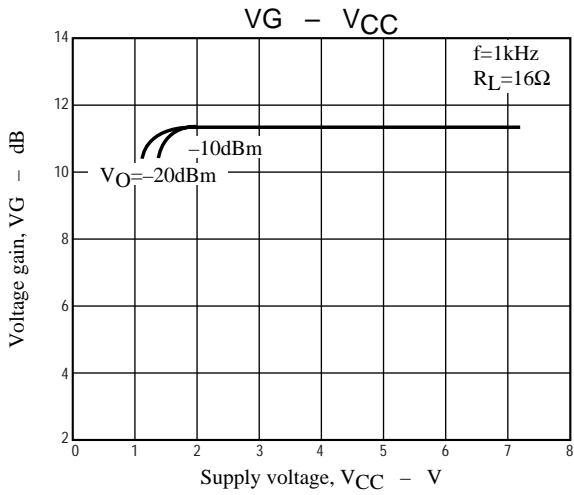
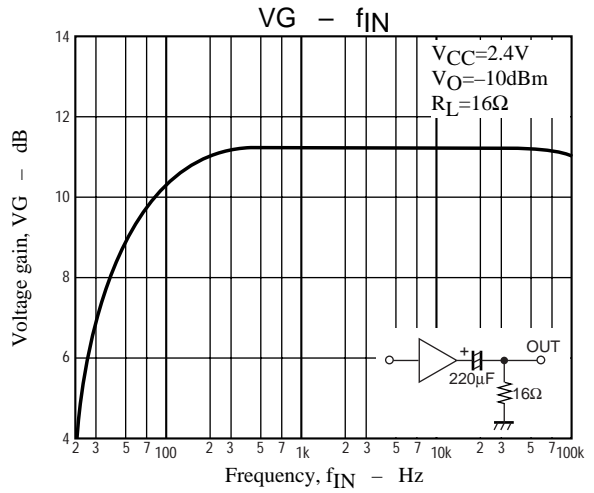
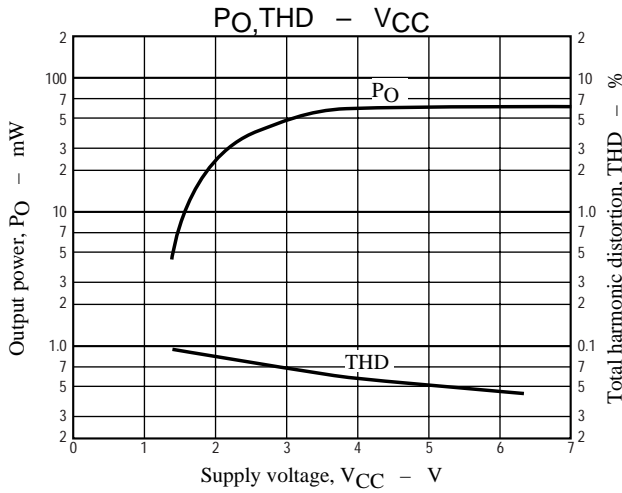
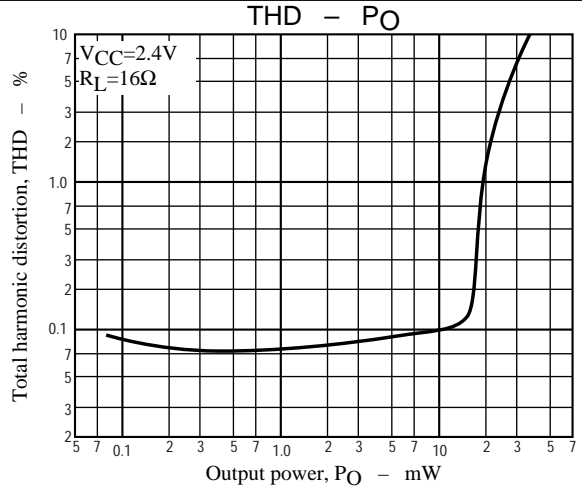
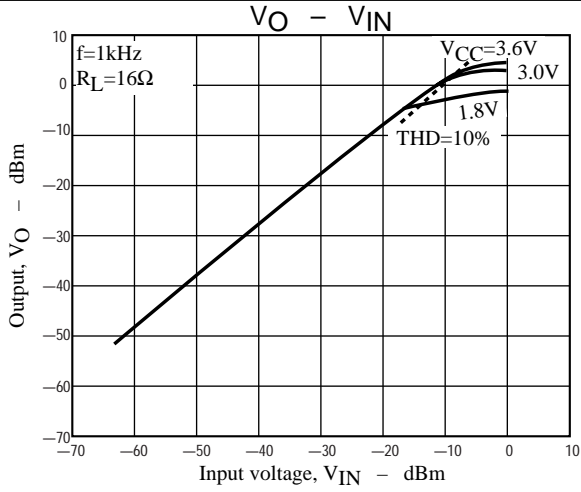

# LA4534M

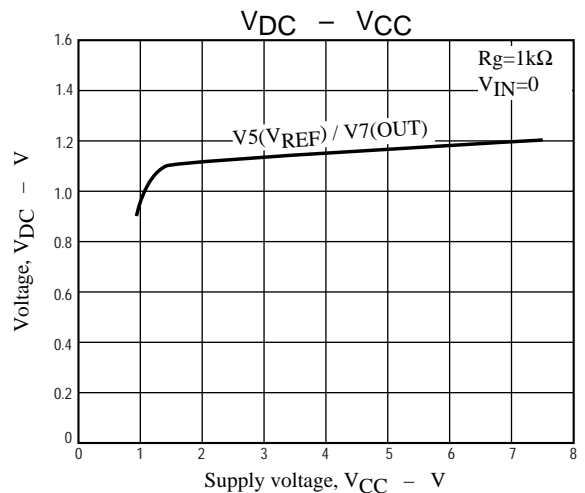
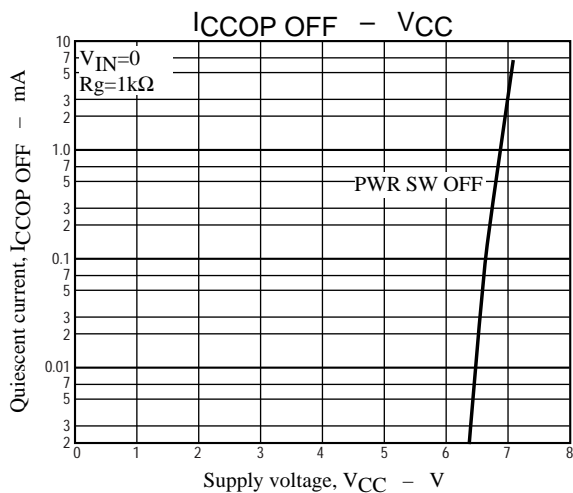
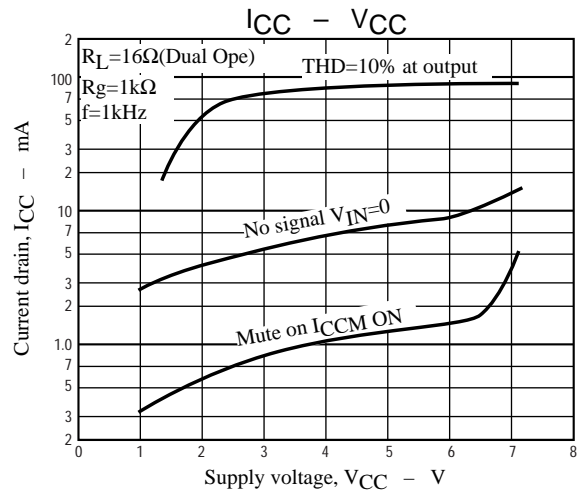
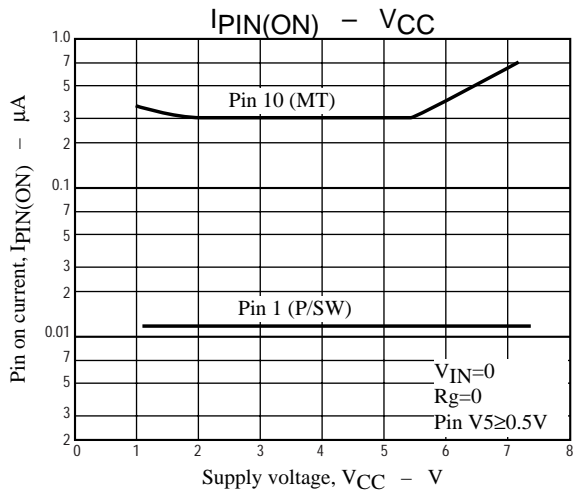
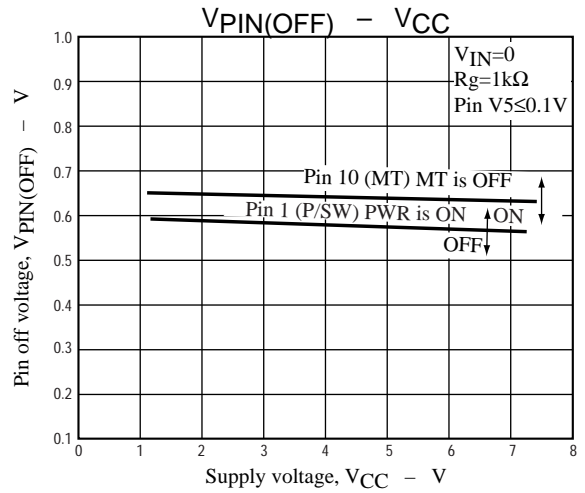
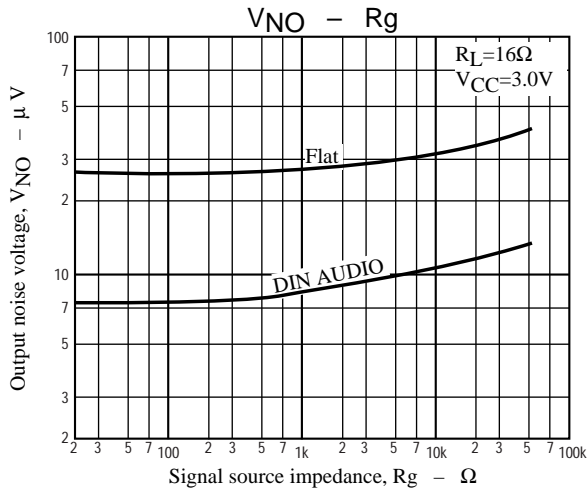
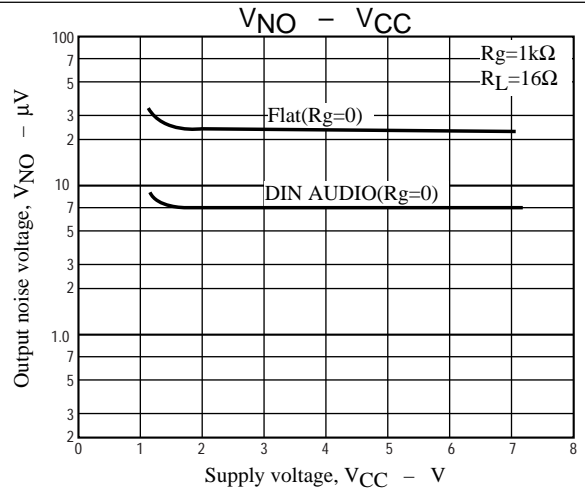
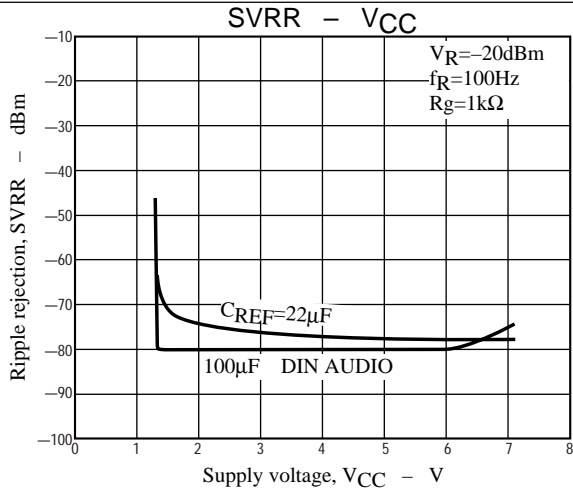

# LA4534M

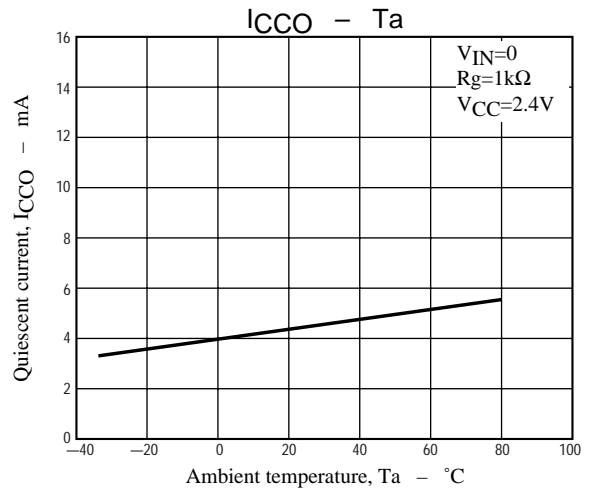
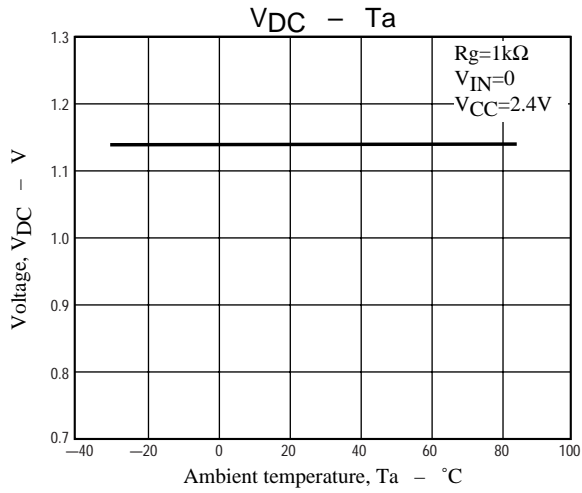
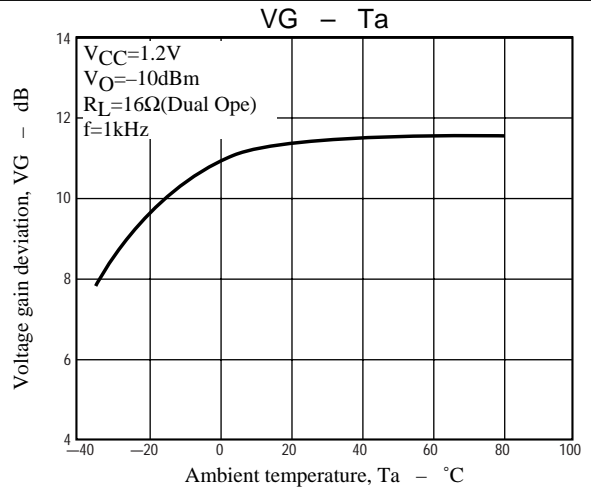
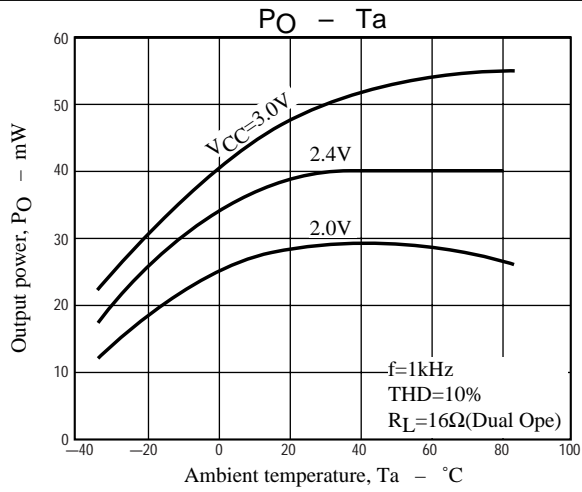

P.SW OFF

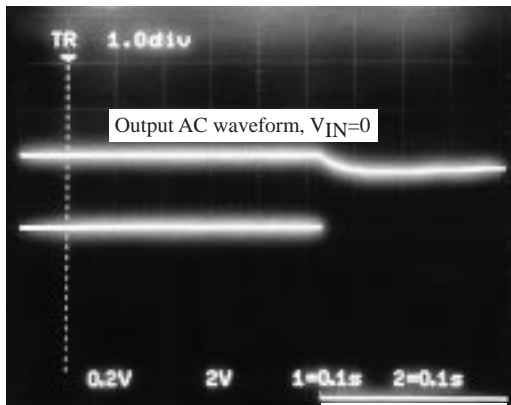

P.SW DC waveform

P.SW OFF

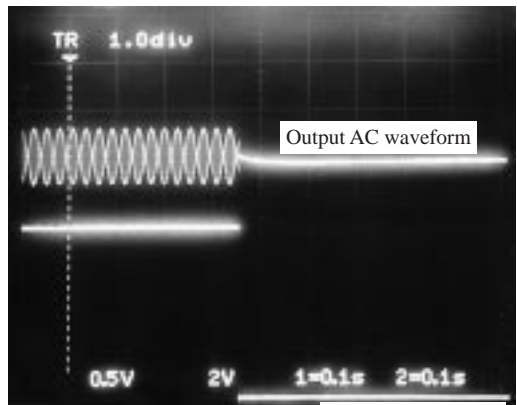

P.SW DC waveform

P.SW OFF

P.SW ON

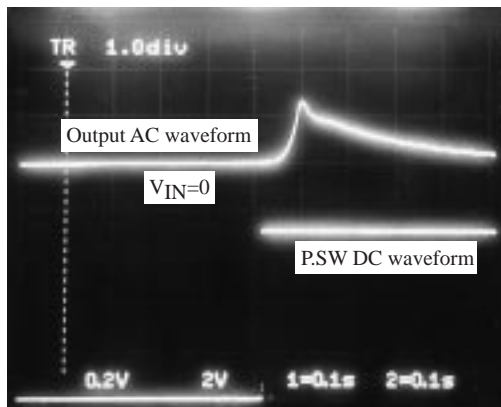

P.SW ON

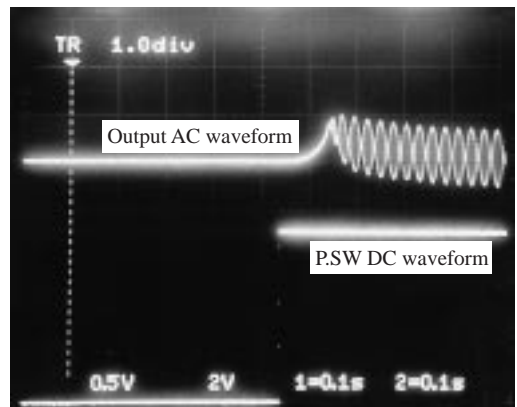

P.SW ON

# LA4534M

M.SW OFF

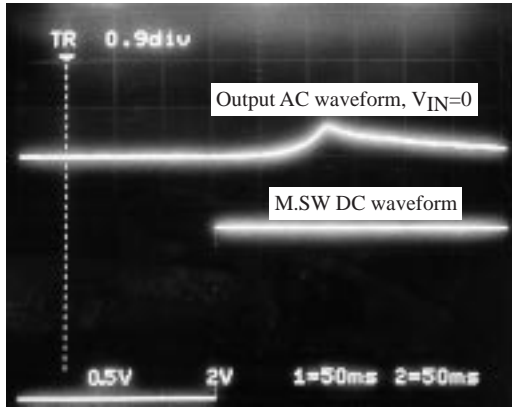

M.SW OFF

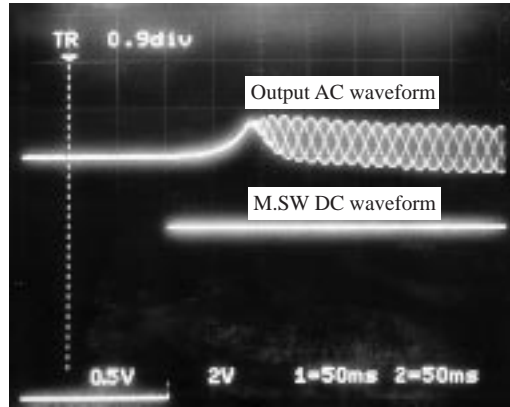

M.SW OFF

M.SW ON

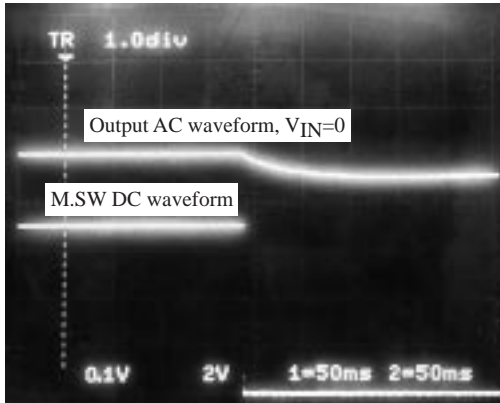

M.SW ON

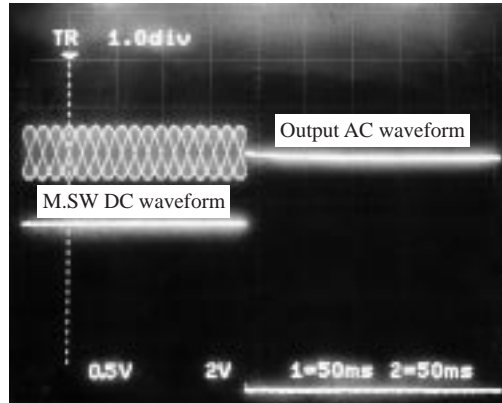

M.SW ON

## Application Notes

- Popping noise reduction

The switching sequence shown below can minimize popping noise.

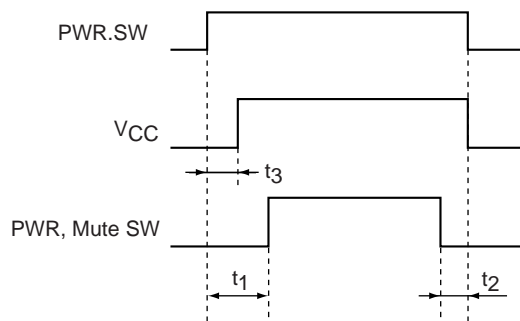

A11154

To minimize popping noise, the PWR mute switch should be turned on  $t_1$  (about 0.1s) after power-on and turned off  $t_2$  (about 0.1s) before power-off. Turn on and off the PWR mute switch by applying  $V_{CC}$  with the PWR be is no state.



- Specifications of any and all SANYO products described or contained herein stipulate the performance, characteristics, and functions of the described products in the independent state, and are not guarantees of the performance, characteristics, and functions of the described products as mounted in the customer's products or equipment. To verify symptoms and states that cannot be evaluated in an independent device, the customer should always evaluate and test devices mounted in the customer's products or equipment.
- SANYO Electric Co., Ltd. strives to supply high-quality high-reliability products. However, any and all semiconductor products fail with some probability. It is possible that these probabilistic failures could give rise to accidents or events that could endanger human lives, that could give rise to smoke or fire, or that could cause damage to other property. When designing equipment, adopt safety measures so that these kinds of accidents or events cannot occur. Such measures include but are not limited to protective circuits and error prevention circuits for safe design, redundant design, and structural design.
- In the event that any or all SANYO products(including technical data, services) described or contained herein are controlled under any of applicable local export control laws and regulations, such products must not be exported without obtaining the export license from the authorities concerned in accordance with the above law.
- No part of this publication may be reproduced or transmitted in any form or by any means, electronic or mechanical, including photocopying and recording, or any information storage or retrieval system, or otherwise, without the prior written permission of SANYO Electric Co., Ltd.
- Any and all information described or contained herein are subject to change without notice due to product/technology improvement, etc. When designing equipment, refer to the "Delivery Specification" for the SANYO product that you intend to use.
- Information (including circuit diagrams and circuit parameters) herein is for example only ; it is not guaranteed for volume production. SANYO believes information herein is accurate and reliable, but no guarantees are made or implied regarding its use or any infringements of intellectual property rights or other rights of third parties.

This catalog provides information as of October, 1998. Specifications and information herein are subject to change without notice.