

**SANYO**

No. 1161D

**LA4510****240mW AF POWER AMPLIFIER****Applications**

- Especially suited for use in 3V micro cassette recorder, mini cassette recorder, headphone stereo applications.

**Features**

- Operating supply voltage range : 2 to 5V
- Low current dissipation (7mA typ/ $V_{CC}=3V$ )
- Output power : 240mW typ at  $V_{CC}=3V, R_L=4\text{ohms}, \text{THD}=10\%$   
40mW typ at  $V_{CC}=3V, R_L=32\text{ohms}, \text{THD}=10\%$
- Built-in muting circuit to be operated at the time of power switch ON capable of varying starting time and making pop noise low.
- Soft clipping

**Maximum Ratings at  $T_a=25^\circ\text{C}$** 

			unit
Maximum Supply Voltage	$V_{CC\text{max}}$	6.0	V
Maximum Output Current	$I_{O\text{peak}}$	570	mA
Allowable Power Dissipation	$P_{d\text{max}}$	700	mW
Operating Temperature	$T_{\text{opr}}$	-10 to +60	$^\circ\text{C}$
Storage Temperature	$T_{\text{stg}}$	-55 to +150	$^\circ\text{C}$

**Operating Conditions at  $T_a=25^\circ\text{C}$** 

		3.0	4.5	V
Recommended Supply Voltage	$V_{CC}$	3.0	4.5	V
Load Resistance	$R_L$	4 to 32	8 to 32	ohm

**Electrical Characteristics at  $T_a=25^\circ\text{C}, V_{CC}=3.0V, R_L=4\text{ohms}, f=1\text{kHz}$ , See Sample Application circuit 1.**

			min	typ	max	unit
Quiescent Current	$I_{CCO(1)}$ No signal			7	12	mA
	$I_{CCO(2)}$ No signal, $V_{CC}=4.5V$			8.5	15	mA
Voltage Gain	VG $R_L=100\text{ohm}$		42	45	48	dB
Output Power	$P_O$ THD=10%		200	240		mW
Total Harmonic Distortion	THD $P_O=100\text{mW}$			0.4	1.5	%
Output Noise Voltage	$V_{NO}$ $R_g=1\text{kohm}, BW=20\text{Hz to }20\text{kHz}$			0.2	0.5	mV
Output Ripple Voltage	$V_{rp}$ $R_g=0, f_R=100\text{Hz}, V_R=50\text{mV}$			0.7		mV

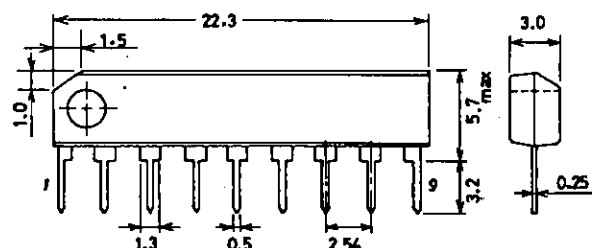
**Package Dimensions 3017B**  
(unit: mm)

Equivalent Circuit Block Diagram

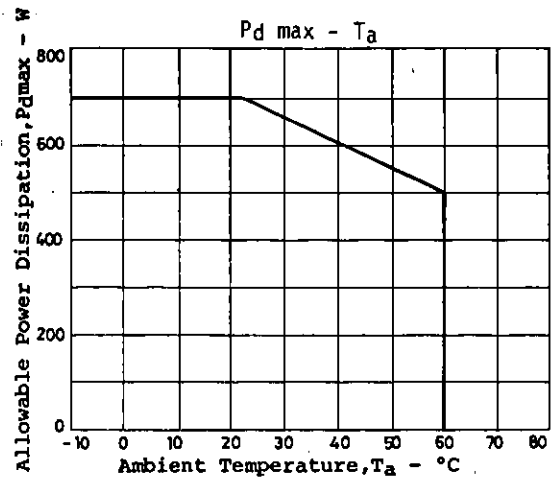
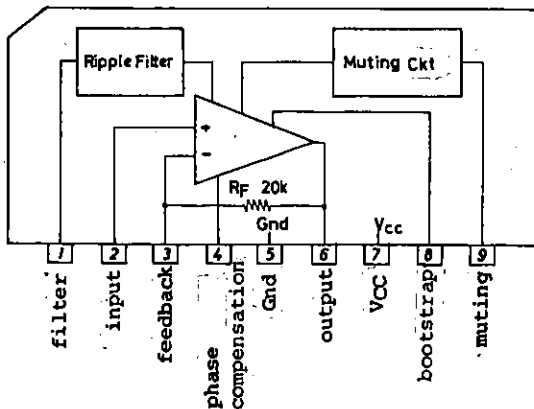

Sample Application Circuit 1 : Speaker load

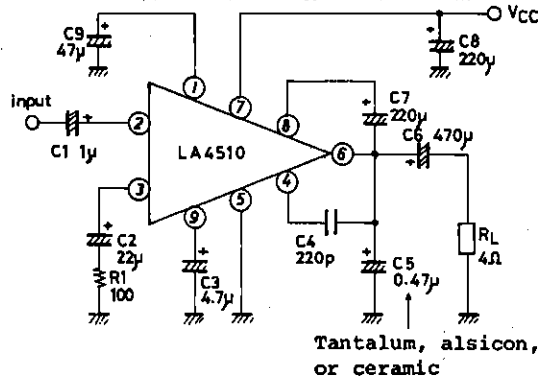

Unit (resistance: Ω, capacitance: F)

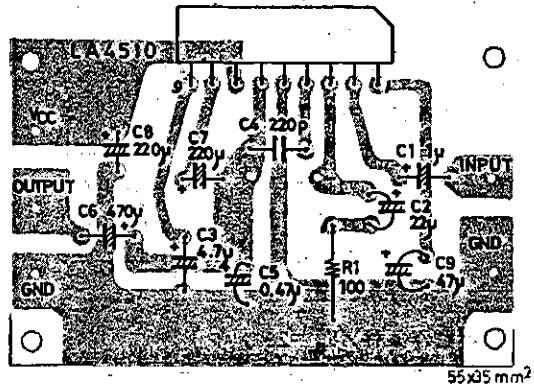

Sample printed circuit pattern (Cu-foiled area)

1. Description of external parts

- C1(1µF) . Input capacitor (Coupling capacitor for input signal)  
Decreasing the capacitance value lowers the frequency response at low frequencies.
- C2(22µF) . Feedback capacitor (Bypass of feedback signal)  
Decreasing the capacitance value lowers the frequency response at low frequencies; increasing the capacitance value makes the starting time later.
- C3(4.7µF) . Muting capacitor  
Decreasing the capacitance value makes the starting time earlier; removing C3 causes pop noise. Increasing the capacitance value makes the starting time later.
- C4(220pF) . Phase compensation capacitor (Phase compensation by local feedback)  
Decreasing the capacitance value causes the frequency response to extend at high frequencies, and thereby oscillation is liable to occur. Increasing the capacitance value worsens distortion factor at high frequencies.
- C5(0.47µF) . Oscillation blocking capacitor  
Decreasing the capacitance value causes oscillation to liable to occur. Using an ordinary electrolytic capacitor may cause oscillation to occur at a low temperature. Use a tantalum or alsicon electrolytic capacitor that is good in temperature characteristic.
- C6(470µF) . Output capacitor (Cutoff of DC to speaker)  
Decreasing the capacitance value causes insufficient power at low frequencies.
- C7(220µF) . Bootstrap capacitor (Feedback from output stage)  
Decreasing the capacitance value causes insufficient power at low frequencies, especially when voltage is reduced.

Continued on next page.

Continued from preceding page.

- C8(220uF) . Power capacitor (Drop in power impedance)  
Decreasing the capacitance value causes motor noise, etc. to be entered easily. Removing C8 may cause oscillation to occur.
- C9(47uF) . Capacitor for ripple filter (Filter for bias voltage)  
Decreasing the capacitance value causes the circuit to be subjected to the influence of power supply, and thereby ripple is liable to occur.
- ri(100ohms) . Feedback resistor (Setting of voltage gain)  
Decreasing the resistance value increases voltage gain, but worsens distortion factor, and thereby gain varies. Increasing the resistance value causes oscillation to liable to occur.

2. Setting of starting time

The LA4510 contains a muting circuit to be operated at the time of power switch ON/OFF. Thus, pop noise coming from power amplifier and preamplifier is rejected. The starting time depends on the capacitance value of feedback capacitor C2 as well as muting capacitor (C3).

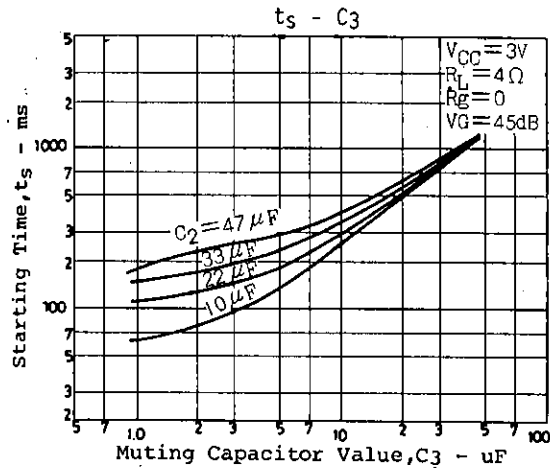
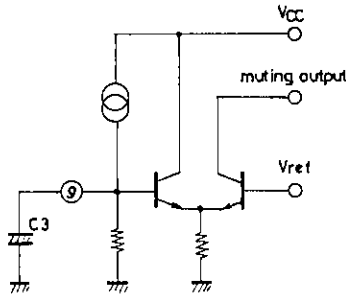

3. Voltage Gain

Voltage gain depends on the ratio of internal resistance value (20kohms) to external resistance value (R1). However, since setting of open loop voltage gain is a little on the low side (62dB) due to soft clipping, it is not recommendable to use the IC at a voltage gain greater than recommended. If the IC is used at a voltage gain less than recommended, take care not to cause oscillation to occur.

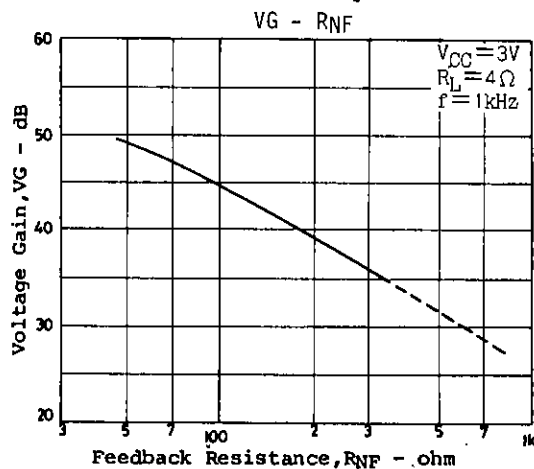

4. Action to prevent oscillation

If oscillation occurs, check C5. The larger the capacitance value is or the smaller the value of tan δ is if the capacitance value is the same, C5 acts more effectively against oscillation. Using an electrolytic capacitor as C5 may cause oscillation to occur at a low temperature.

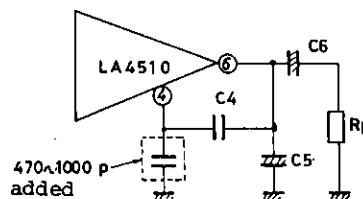

It is recommendable to use a tantalum or alsicon electrolytic capacitor that is good in temperature characteristic. For oscillation that occurs at a decreased voltage gain, increase the capacitance value of C4. If it is impossible for C4, C5 to act effectively against oscillation, add a ceramic capacitor of 470 to 1000pF across pin (4) and GND. In this case, distortion factor at high frequencies worsens to some extent.

5. Removal of bootstrap capacitor

In applications where more power than required is available (approximately 60% of rating), it is possible to remove bootstrap capacitor C7 (pin (7)-to-pin (8) short). However, since this causes clipping unbalance to occur, this unbalance must be compensated by use of a resistor and a diode. A simple compensation method is shown below. This method makes it possible to attain clipping balance at a certain supply voltage only.

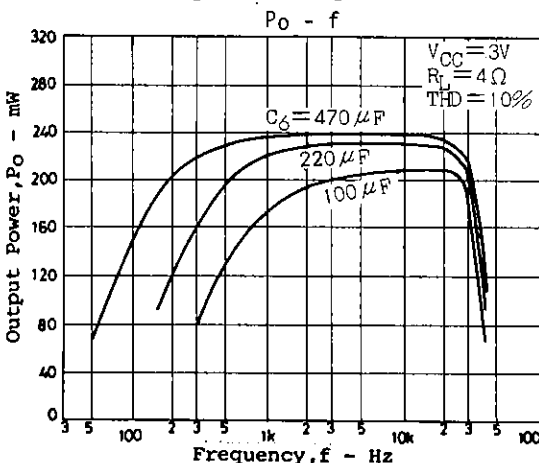
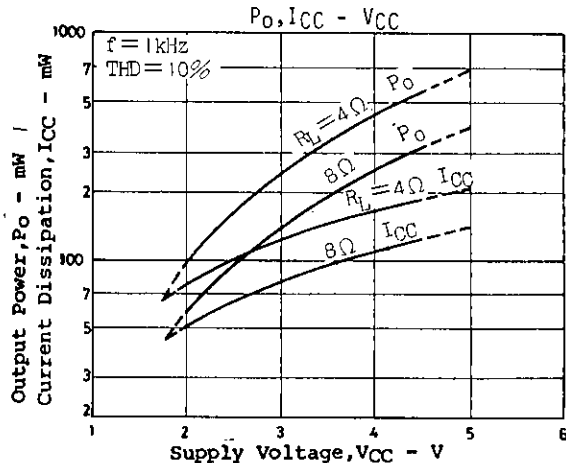
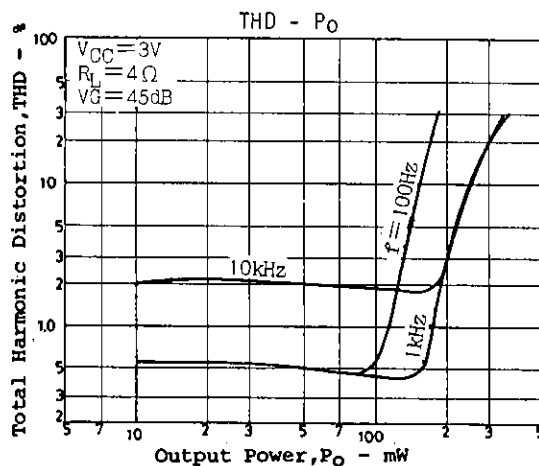
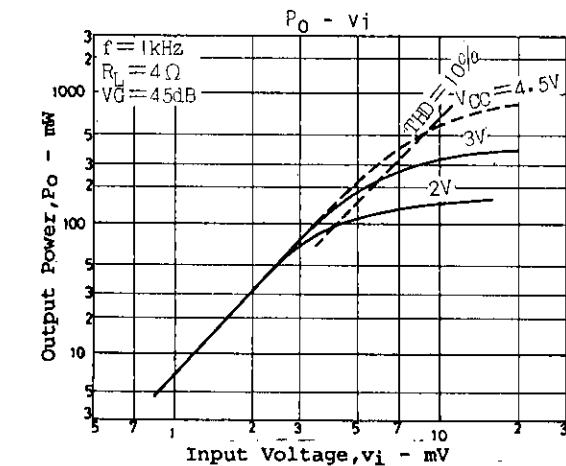
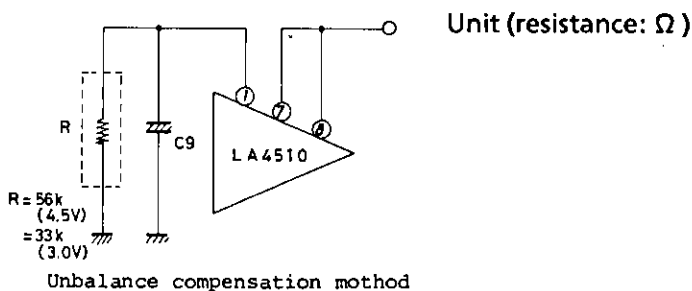

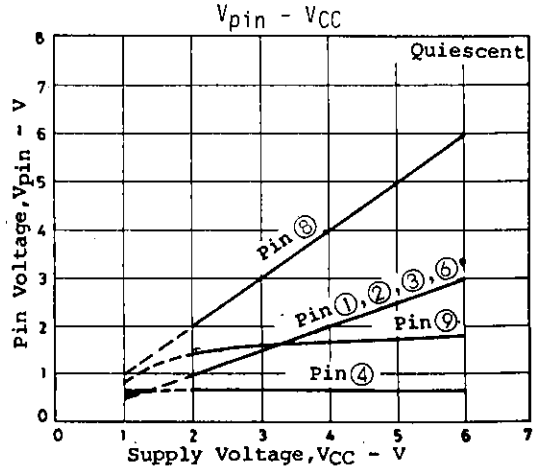
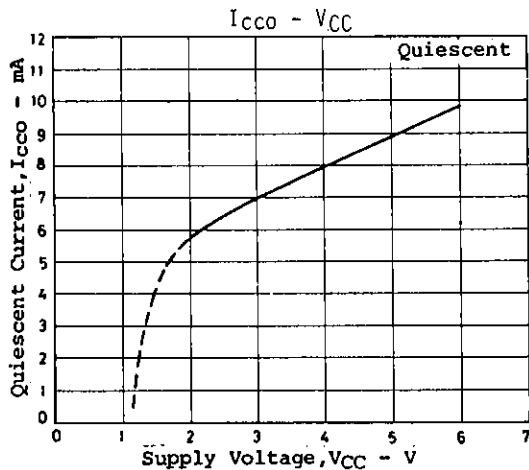
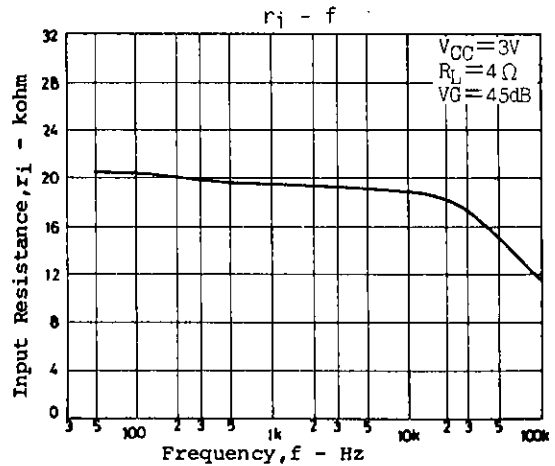
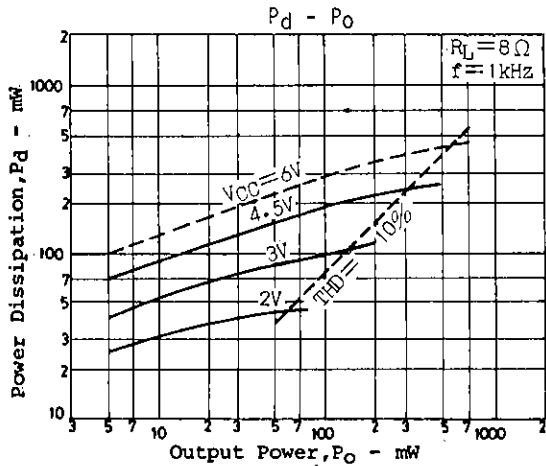
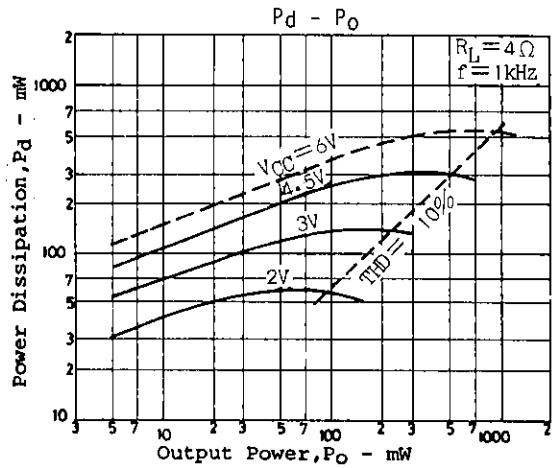
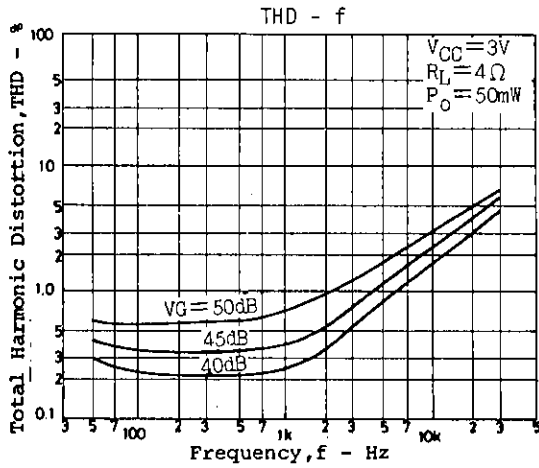
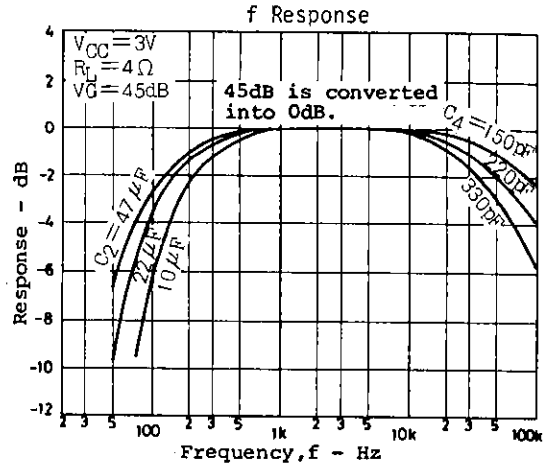
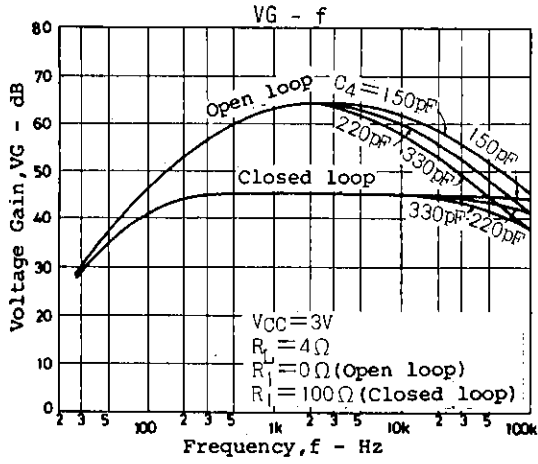

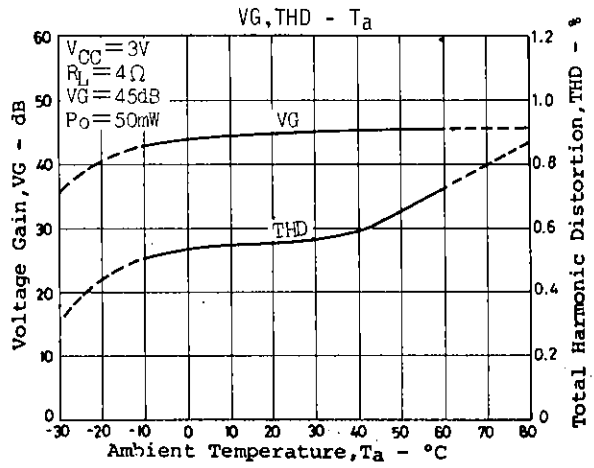
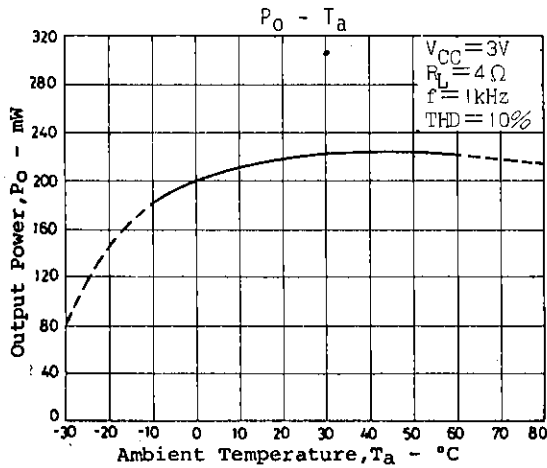
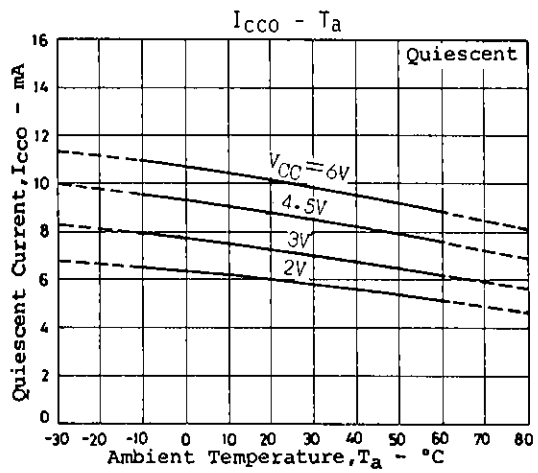
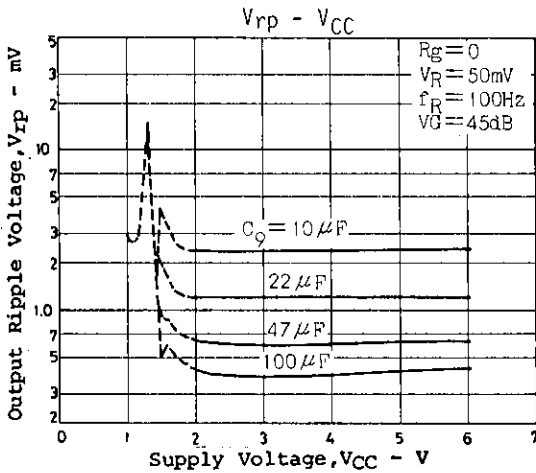
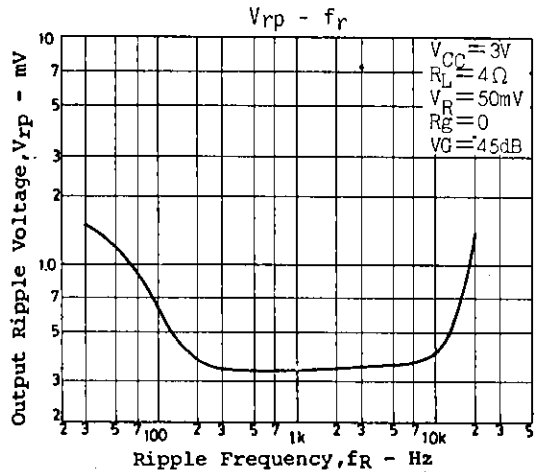
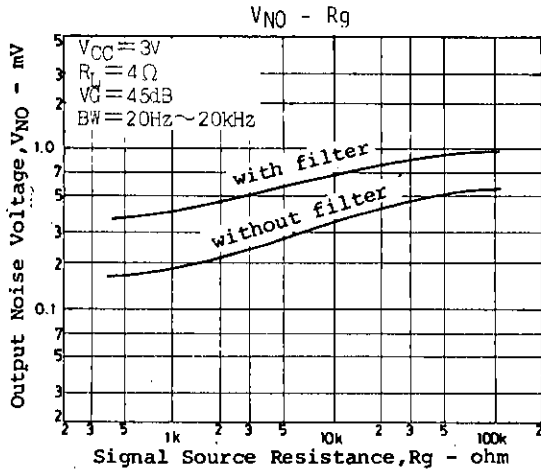

Sample Application Circuit 2 : Headphone load

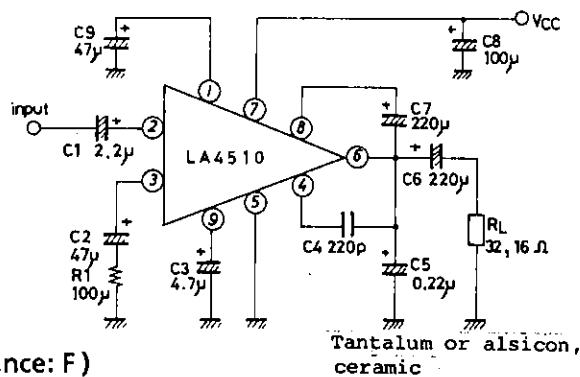

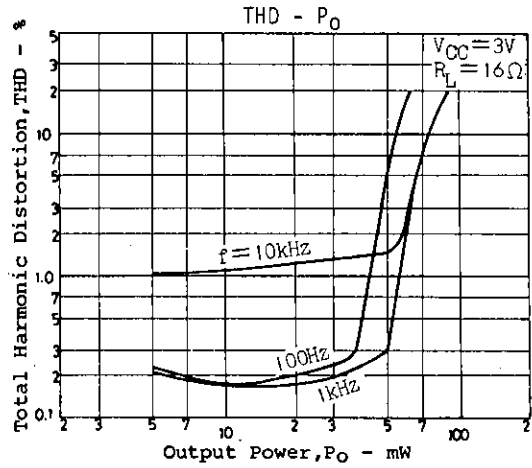
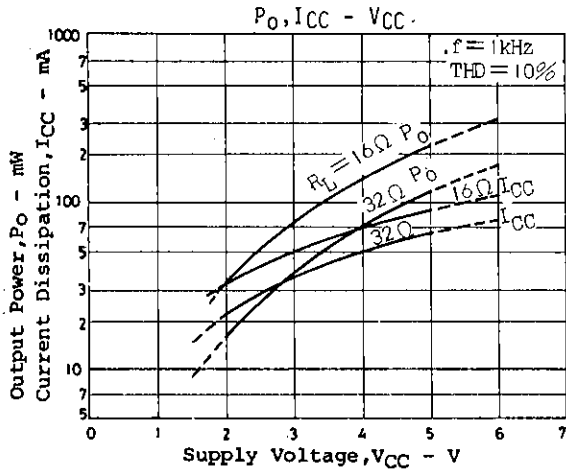

Sample Application Circuit 3 : Bridge

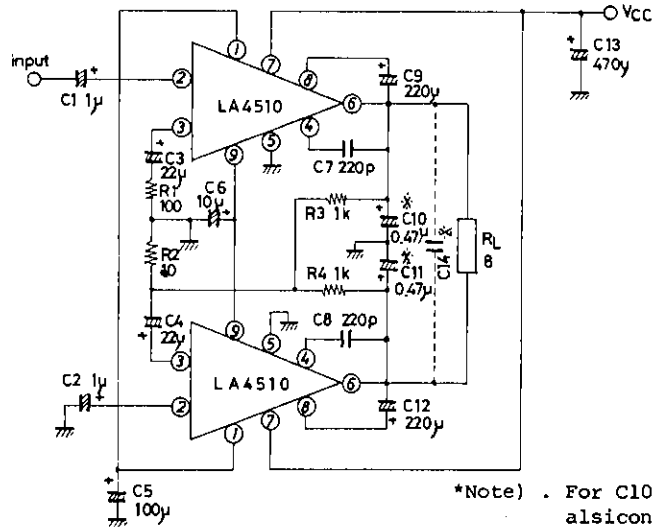

\*Note) . For C10,C11, use tantalum or alscion electrolytic capacitor.  
 . If oscillation occurs, add C14 (0.1 to 0.2u ceramic capacitor).

Unit (resistance:  $\Omega$ , capacitance: F)

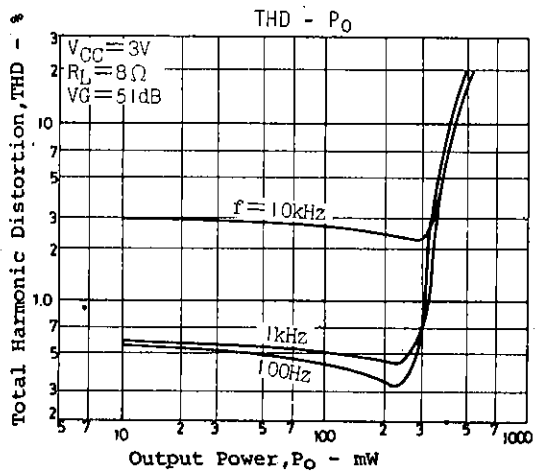
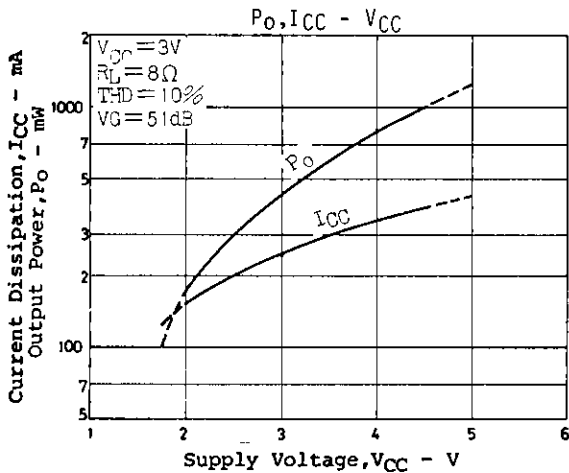

### Proper cares in using IC

#### . Maximum ratings

If the IC is used in the vicinity of the maximum ratings, even a slight variation in conditions may cause the maximum ratings to be exceeded, thereby leading to breakdown. Allow an ample margin of variation for supply voltage, etc. and use the IC in the range where the maximum ratings are not exceeded.

#### . Pin-to-pin short

If power is applied when the space between pins is shorted, breakdown or deterioration may occur. When mounting the IC on the board or applying power, make sure that the space between pins is not shorted with solder, etc.

#### . Printed circuit pattern

When designing the printed circuit pattern, make the power supply, output, and ground lines thick and short and arrange the pattern and parts so that no feedback loop is formed between input and output. Place power capacitor C8, oscillation blocking capacitors C4, C5 as close to IC pins as possible to prevent oscillation from occurring. Refer to the sample printed circuit pattern.

■ No products described or contained herein are intended for use in surgical implants, life-support systems, aerospace equipment, nuclear power control systems, vehicles, disaster/crime-prevention equipment and the like, the failure of which may directly or indirectly cause injury, death or property loss.

■ Anyone purchasing any products described or contained herein for an above-mentioned use shall:

- ① Accept full responsibility and indemnify and defend SANYO ELECTRIC CO., LTD., its affiliates, subsidiaries and distributors and all their officers and employees, jointly and severally, against any and all claims and litigation and all damages, cost and expenses associated with such use:
- ② Not impose any responsibility for any fault or negligence which may be cited in any such claim or litigation on SANYO ELECTRIC CO., LTD., its affiliates, subsidiaries and distributors or any of their officers and employees jointly or severally.

■ Information (including circuit diagrams and circuit parameters) herein is for example only; it is not guaranteed for volume production. SANYO believes information herein is accurate and reliable, but no guarantees are made or implied regarding its use or any infringements of intellectual property rights or other rights of third parties.