

SANYO

No. 912D

LA3220**2-CHANNEL EQUALIZER AMPE WITH ALC****FEATURES**

- Dual pre-amp with built-in ALC (pre-amp x 2 + ALC x 2).
- Due to high gain, recording amp can be formed separately. (variable monitor possible)
- ALC and direct motor drive obtained through SEPP output stage.
- Good ALC response balance between channels.
- Good reduced voltage characteristic.
- Excellent channel separation.
- Quick stabilization during power supply input.

MAXIMUM RATINGS/ $T_a = 25^\circ\text{C}$

				unit
Maximum power supply voltage	V_{CC} max		14	V
Allowable power consumption	P_d max	$T_a \leq 40^\circ\text{C}$	600	mW
Operating ambient temperature	T_{opg}		-20 ~ +75	$^\circ\text{C}$
Storage ambient temperature	T_{stg}		-40 ~ +125	$^\circ\text{C}$
ALC Tr. allowable current			3.5	mA

RECOMMENDED OPERATING CONDITIONS/ $T_a = 25^\circ\text{C}$

				unit
Recommended power supply voltage	V_{CC}		5 ~ 13	V
Load resistance	R_L		not less than 680 Ω	

OPERATING CHARACTERISTICS/ $T_a = 25^\circ\text{C}$, $V_{CC} = 5\text{ V}$, $f = 1\text{ kHz}$, $R_L = 10\text{ k}\Omega$ (PB), $R_L = 680\Omega$ (REC)

See specified Test Circuit.

			min	typ	max	unit
Quiescent current	I_{CCO}			4.5	10	mA
Open voltage gain	V_{G0}			85		dB
Voltage gain	V_G	PB		40		dB
		REC		58		dB
Maximum output voltage	v_O max	THD = 1%, PB	0.9	1.2		V
Total harmonic distortion	THD	$v_O = 0.5\text{ V}$, PB		0.1	1.0	%
Input resistance	r_i		21	30		k Ω
Channel separation	SEP	$R_g = 2.2\text{ k}\Omega$, $v_O = 0\text{ dBm}$, PB	40	50		dB
Noise voltage converted to input	V_{NI}	$R_g = 2.2\text{ k}\Omega$, B.P.F. = 20 Hz ~ 20 kHz, PB		1.0	2.0	μV
ALC width		$v_i = -60\text{ dBm}$, REC	35	45		dB
ALC balance		$v_i = -20\text{ dBm}$, REC		0	2.0	dB
ALC distortion		$v_i = -20\text{ dBm}$, REC		0.5	2.0	%

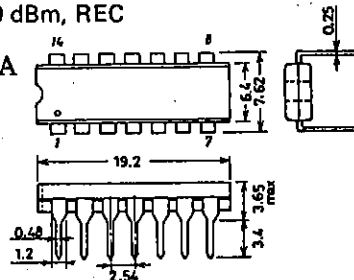
Package Dimensions 3003A
(unit: mm)

SANYO: DIP14

SANYO Electric Co., Ltd. Semiconductor Business Headquarters
TOKYO OFFICE Tokyo Bldg., 1-10, 1 Chome, Ueno, Taito-ku, TOKYO, 110 JAPAN

LA3220

Equivalent Circuit Block Diagram

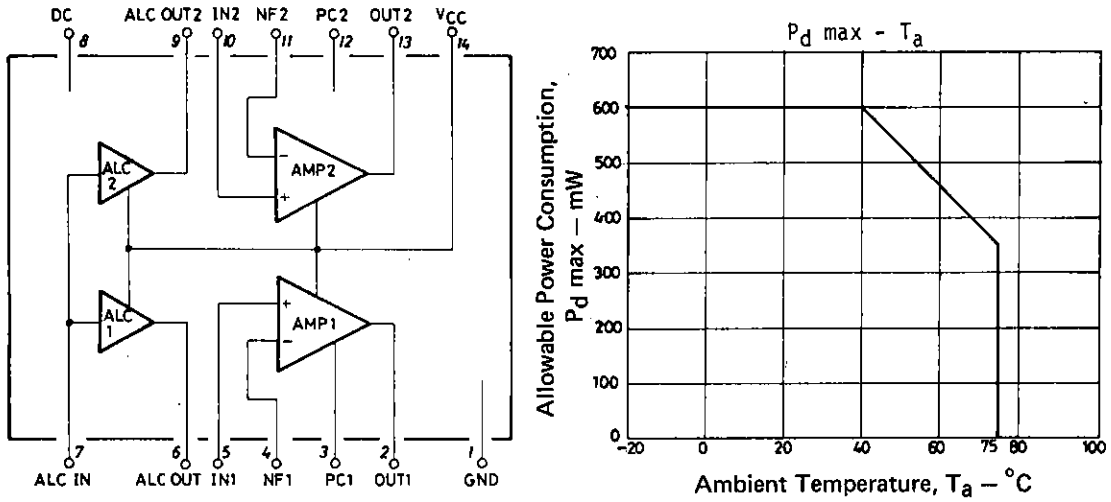

Test Circuit

Unit (resistance: Ω , capacitance: F)

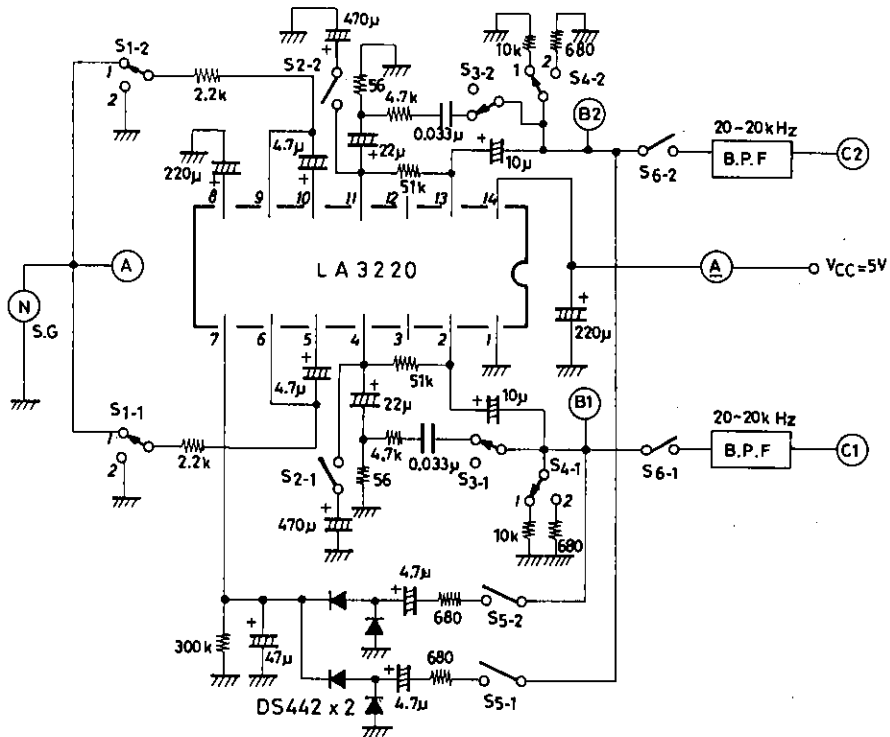

See next page for test procedure.

Test Procedure

Item	S1	S2	S3	S4	S5	S6	Measurement location	Procedure
ICCO	2	off	off	1	off	off	—	Read ammeter.
VGo	1	on	off	1	off	off	A, B	Measure at $V_{Go} = 20 \log V_O/V_I$ (dB) with input voltage at V_I ; output voltage at V_O .
VG	1	off	on	1	off	off	A, B	$VG = 20 \log V_O/V_I$ (dB)
V_O max	1	off	on	1	off	off	B	Measure output voltage V_O at THD = 1%.
THD	1	off	on	1	off	off	B	Measure distortion factor at $V_O = 0.5$ V.
CH sep	S1-1 S1-2 1 2 2 1	off	on	1	off	off	B	Measure crosstalk of amp 1, 2, at output voltage $V_O = 0$ dBm.
VNI	2	off	on	1	off	on	C	Obtain output noise voltage in 1 kHz gain equivalent when $R_g = 2.2$ k Ω .
ALC width	1	off	off	2	on	off	B	Input voltage range from when input voltage $V_I = -60$ dBm until output voltage V_O goes up 3 dB.
ALC balance	1	off	off	2	on	off	B	Output voltage V_O level difference between amp 1, 2 when input voltage $V_I = -20$ dBm is applied.
ALC distortion	1	off	off	2	on	off	B	Measure distortion factor when input voltage $V_I = -20$ dBm is applied.

■ Sample Application Circuit: Variable Monitor System

Unit (resistance: Ω , capacitance: F)

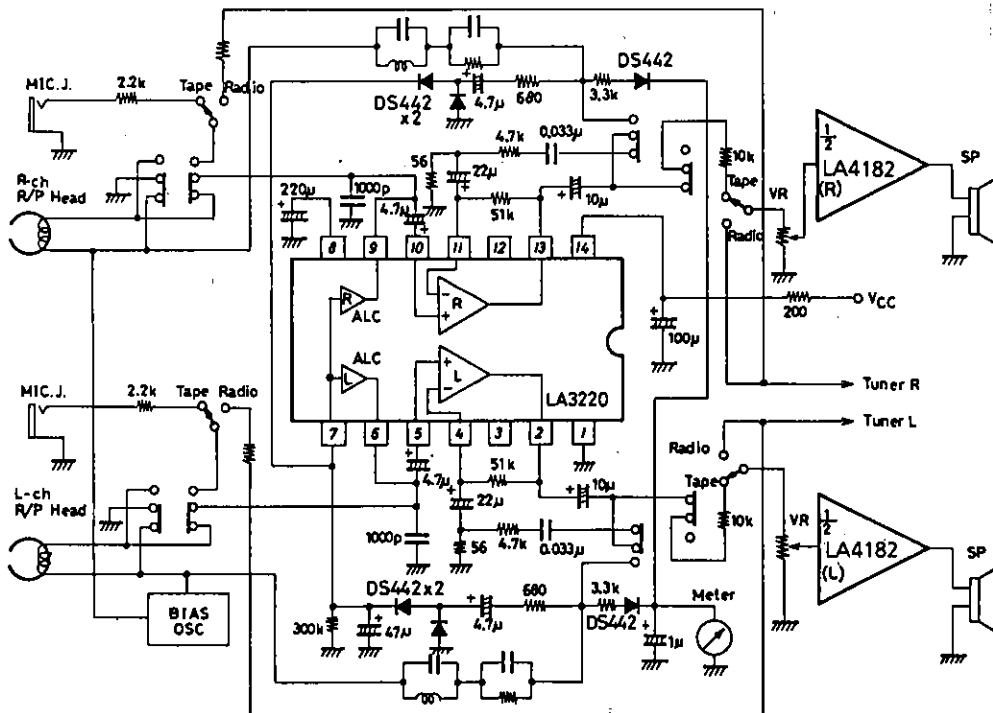

Unit (resistance: Ω , capacitance: F)

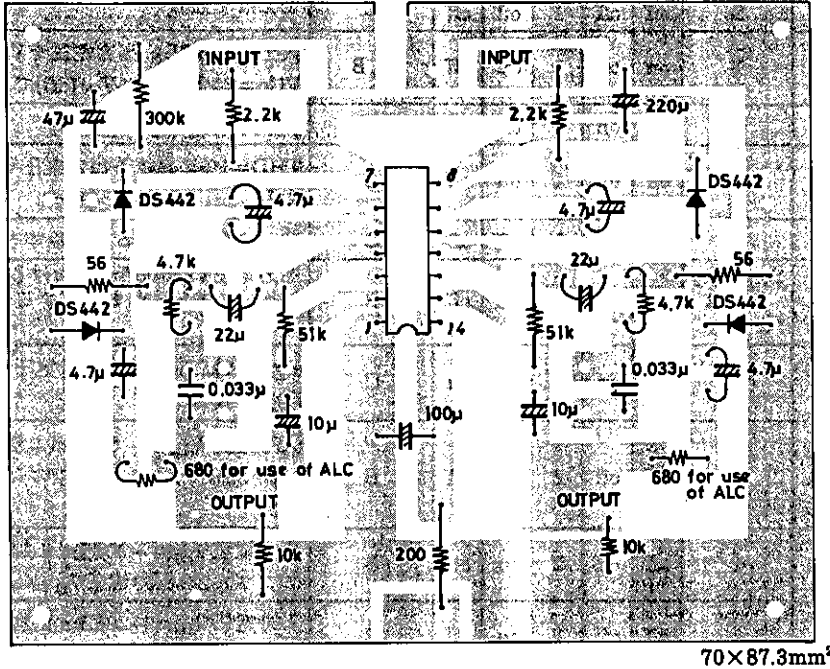

Example of Print Pattern (copper foil side)

1. Circuit Construction

- 1) This is a dual pre-amp composed of AMP x 2, ALC x 2. Input is obtained from NPN differential TR1, TR2; and differential load uses active element TR3 to obtain high voltage gain. The output stage is push-pull system with drive for low load impedance, and can be directly connected to ALC circuit and meter circuit. Also, because the amp open loop gain is sufficiently high, it can be used for recording amp and variable monitor is possible. Input impedance is determined by built-in resistor R1, and is 30 k Ω .

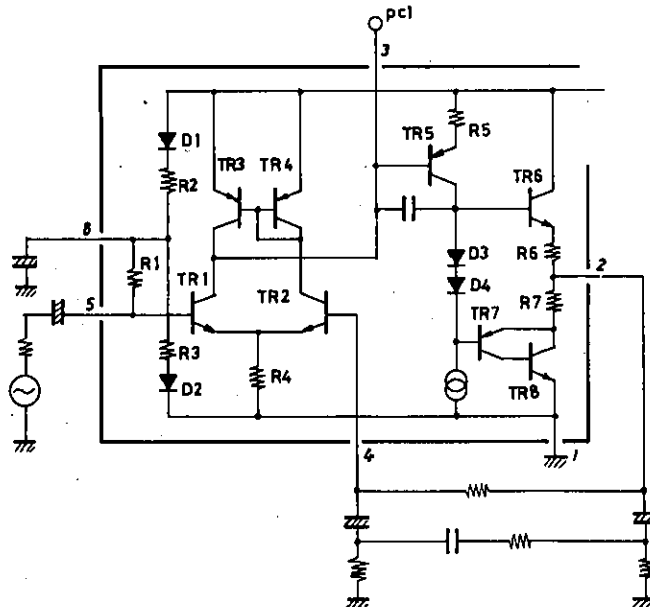

2) ALC Circuit

The ALC circuit is composed of TR1, TR2, and due to DC voltage applied to the 7 control terminals, allows variable impedance between TR1 collector and emitter and controls pre-amp input level.

* Attack Time and Recovery Time

Attack time is between when input signal is applied until ALC begins to operate. Recover time is between-justed by R2,C3 time constant. Recovery time is between

Continued on next page.

Continued from preceding page.

when input signal disappears to when amp level returns to the original level. The recovery time is adjusted by C4, R3 time constant. The rectification circuit, which obtains ALC control voltage, should be a voltage doubler with superior compression ratio. Also, for low voltage 6 V sets, etc., a germanium diode is recommended for D1, D2.

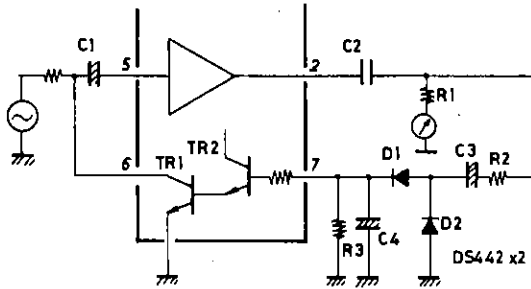

2. Closed loop gain VG (f = 1 kHz)

Closed loop voltage gain is gotten at (f = 1 kHz) $VG \approx 20 \cdot \log Z1/Z3$

If $Z1 = 7.2 \text{ k}\Omega$

$Z3 = 56\Omega$

$VG = 20 \log 7.2 \times 10^3 / 56$ becomes = 42 dB.

Therefore, equalizer response is determined by these constants.

So, playback amp gain is:

- a. $20 \log R1/R3$ in low frequency regions
- b. $20 \log Z2/Z3$ in high frequency regions

Recording amp gain is

$VG = 20 \log R1/R3$

Unit (resistance: Ω , capacitance: F)

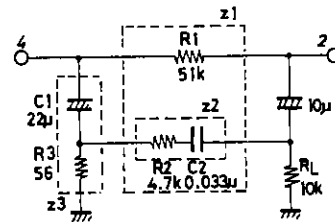

3. External Constants

External constants are related to the operation starting time of the amp. The operation starting time is designed to be within 0.2 sec, but in this case it is necessary that the differential TR1 and TR2 is the same in time constant. The condition is:

$C1 (R1//R2) = R5 \cdot C3$

Example: If $C1 = 220\mu$, $R1//R2 = 5 \text{ k}\Omega$, $R5 = 51 \text{ k}\Omega$ then $C3$ is $22\mu\text{F}$.

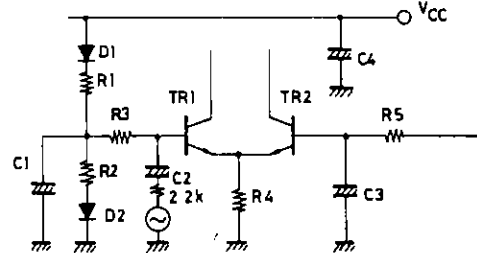

- C1 is a decoupling capacitor, and its capacity changes the ripple rejection rate. (If capacity is large, ripple rejection rate is large.) It is also related to the amp operation starting time, and when R5, C3 time constant is large, C1 must also be made large. The recommended value is $220\mu\text{F}$.
- C2 is an input capacitor, and more than $4.7\mu\text{F}$ is recommended.
- C3 is an NF capacitor, and determines the low region cut-off frequency. If C3 is increased, operation starting time lengthens. $10\mu\text{F}$ is recommended. The recommended constants therefore are:

R5 (R Ω)	C1 (CD)	C2 (IN)	C3 (NF)
51 k ~ 100k Ω	220 μF	4.7 μF	22 μF
200 k Ω	330 μF	10 μF	10 μF

We do not recommend more than 200 k Ω for R5 which lengthens amp operation starting time.

4. Notes on Use

1) Oscillation

When the amp closed loop gain is lowered, oscillation will occur, so when using it with under 40 dB gain, connect 10pF between pin 3 and pin 2, and 0.033 μ (mylar) + 10 Ω to the load end. When closed loop gain is below $VG = 30 \text{ dB}$, it should not be used.

2) Radio Interference Prevention

Connect about 1000pF between input pin (pin 5) and the ground.

3) Maximum Rating

V_{CC} max is $V_{CC} = 14 \text{ V}$, and it should not go over this. The recommended power supply voltage is 5 V ~ 13 V.

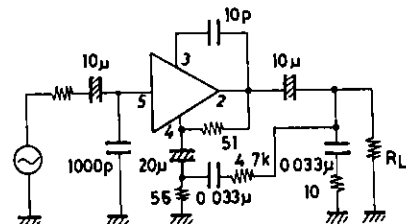

Unit (resistance: Ω , capacitance: F)

4) Load Impedance

The total load impedance as seen from the output terminal should not be less than 680Ω.

5) A short between pins will cause breakdown or deterioration.

6) A load short will cause breakdown or deterioration.

Unit (resistance: Ω, capacitance: F)

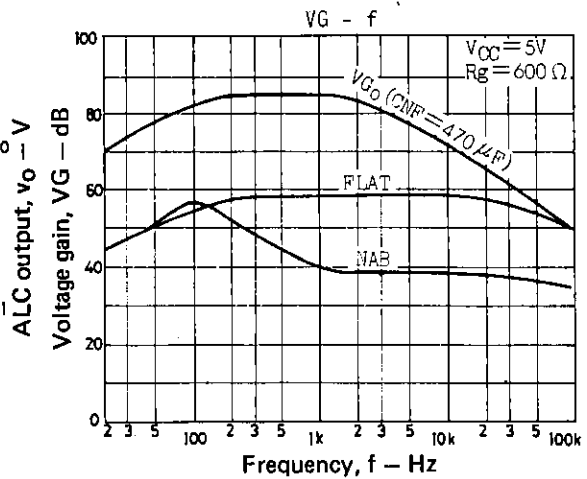
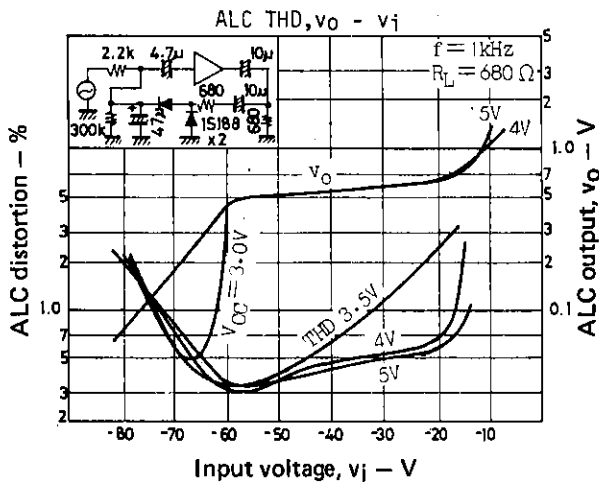
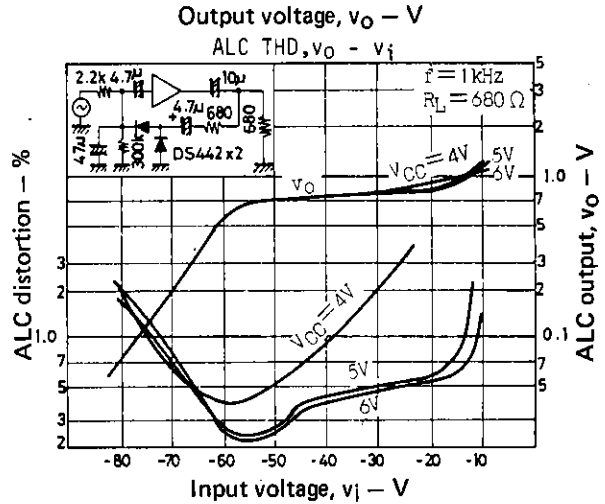
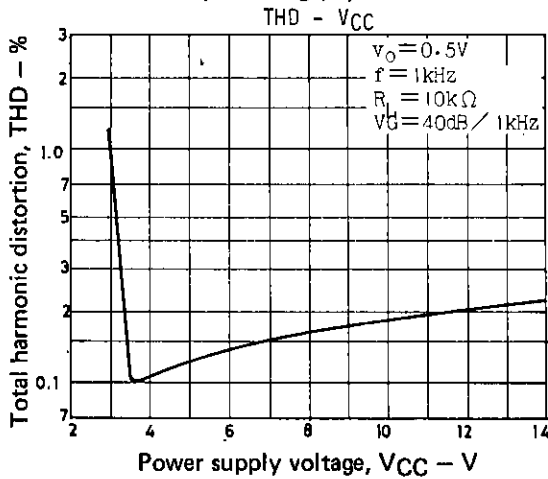
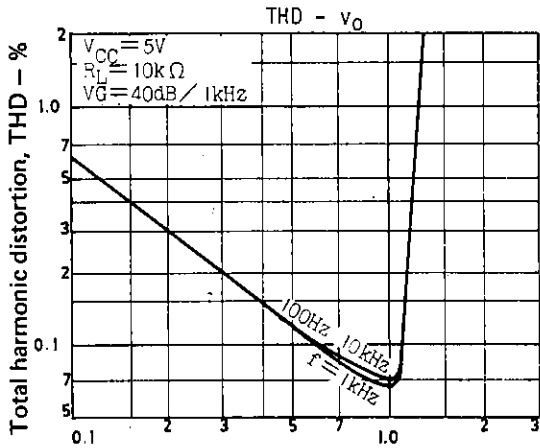
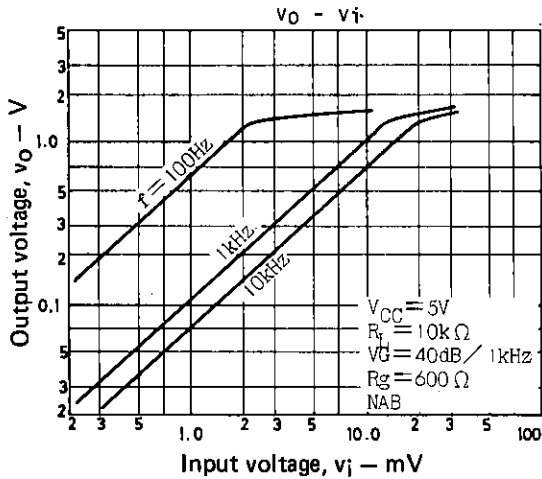

Unit (resistance: Ω , capacitance: F)

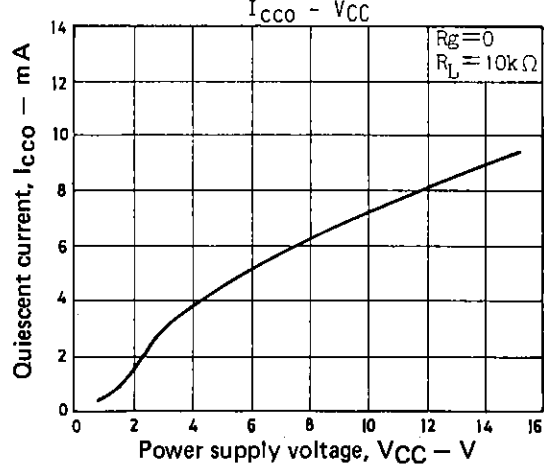
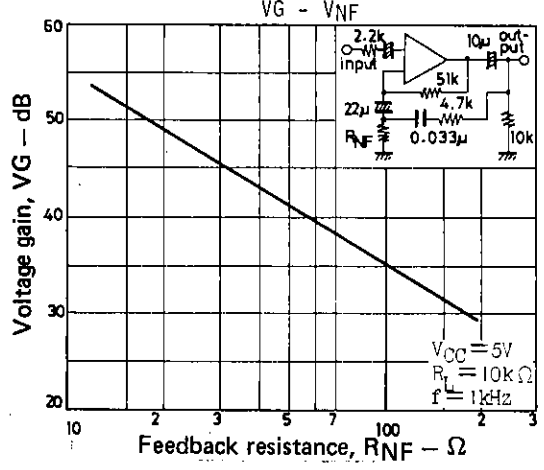
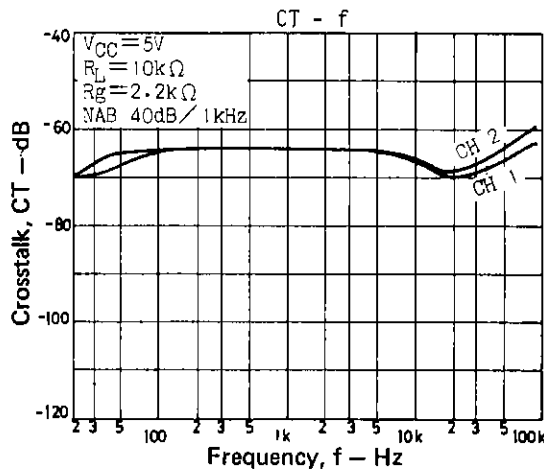
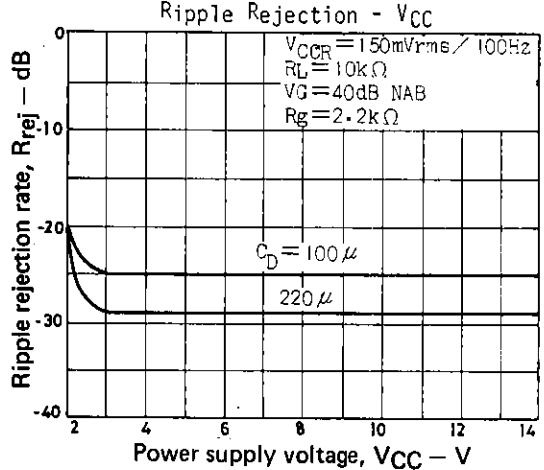
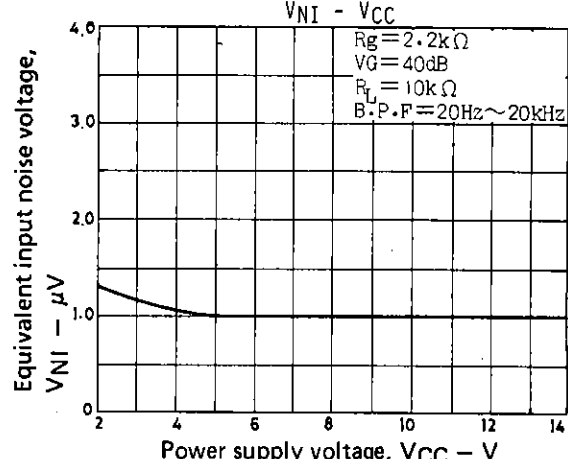
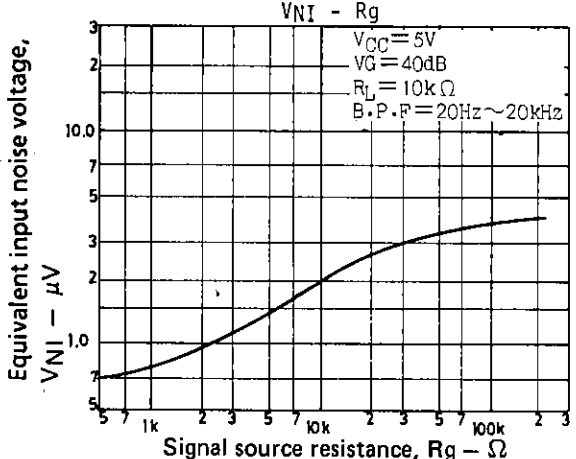
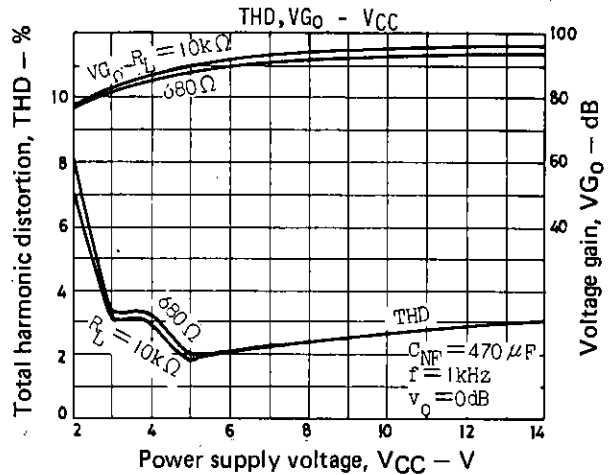
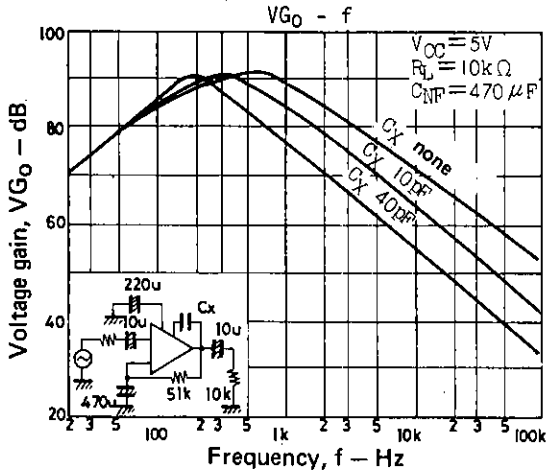

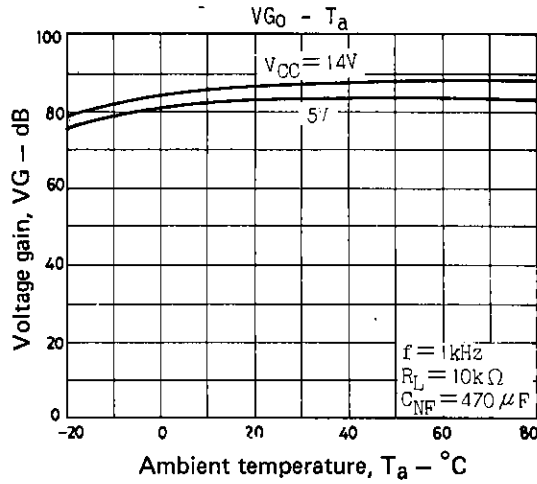
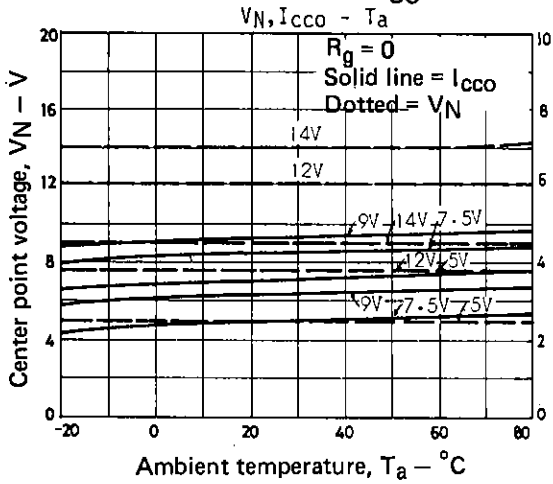
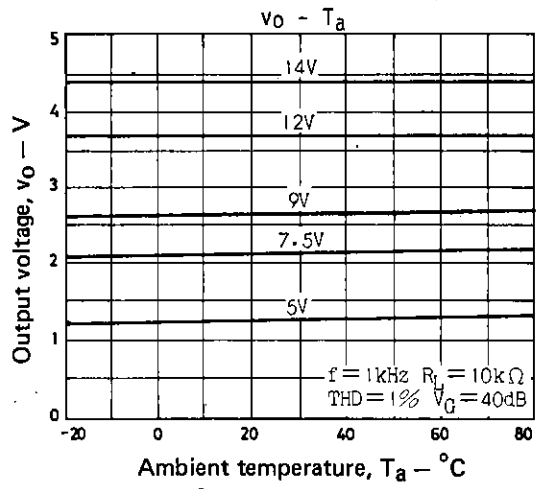
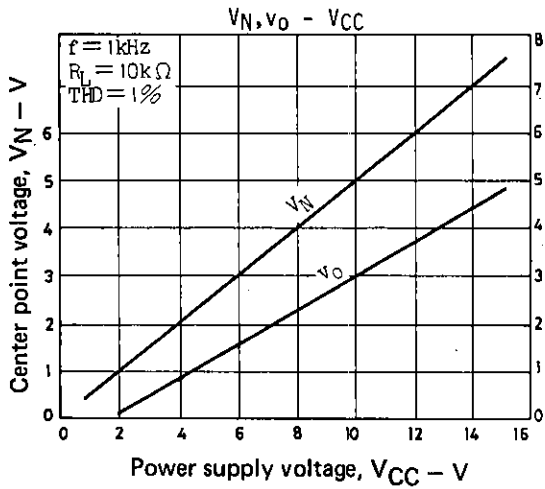

■ No products described or contained herein are intended for use in surgical implants, life-support systems, aerospace equipment, nuclear power control systems, vehicles, disaster/crime-prevention equipment and the like, the failure of which may directly or indirectly cause injury, death or property loss.

■ Anyone purchasing any products described or contained herein for an above-mentioned use shall:

- ① Accept full responsibility and indemnify and defend SANYO ELECTRIC CO., LTD., its affiliates, subsidiaries and distributors and all their officers and employees, jointly and severally, against any and all claims and litigation and all damages, cost and expenses associated with such use;
- ② Not impose any responsibility for any fault or negligence which may be cited in any such claim or litigation on SANYO ELECTRIC CO., LTD., its affiliates, subsidiaries and distributors or any of their officers and employees jointly or severally.

■ Information (including circuit diagrams and circuit parameters) herein is for example only; it is not guaranteed for volume production. SANYO believes information herein is accurate and reliable, but no guarantees are made or implied regarding its use or any infringements of intellectual property rights or other rights of third parties.