

**LA1267****FM/AM Tuner of Electronic Tuning Type****Functions**

FM : IF amplifier, quadrature detector, AF preamplifier, signal meter, tuning indicator drive output (common with stop signal, muting drive output).

AM : RF amplifier, MIX, OSC (with ALC), IF amplifier, detector, AGC, signal meter, tuning indicator drive output (common with stop signal), IF signal output.

Features

- Minimum number of external parts required.
- Excellent S/N.
- Local OSC with ALC.
- Local OSC buffer.
- Tuning indicator pin (common with narrow-band stop signal and muting drive output).
- Variable stop sensitivity (variable separately for FM, AM)
- Low whistle.
- Signal meter pin.
- Especially suited for AM stereo, IF count electronic tuning because of AM IF signal output.

Package Dimensions

unit : mm

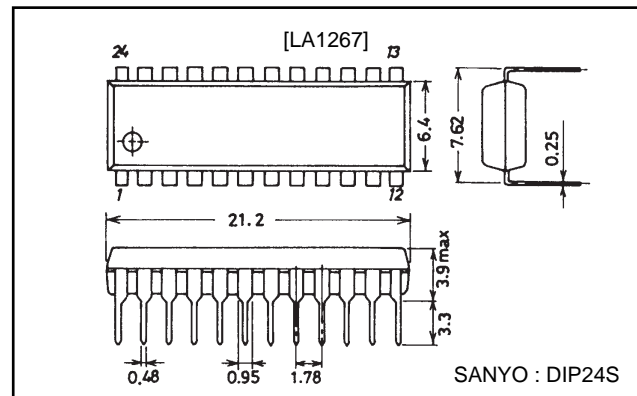
3067-DIP24S**Specifications****Maximum Ratings** at $T_a=25^\circ\text{C}$, See specified Test Circuit.

Parameter	Symbol	Conditions	Ratings	Unit
Maximum supply voltage	$V_{CC \text{ max}}$	Pins 7, 8, 19	16	V
Flow-in current	I_8	Pin 8	20	mA
Flow-out current	I_{22}	Pin 22	1	mA
	I_{24}	Pin 24	2	mA
Allowable power dissipation	$P_d \text{ max}$	$T_a \leq 60^\circ\text{C}$	650	mW
Operating temperature	T_{opr}		-20 to +70	$^\circ\text{C}$
Storage temperature	T_{stg}		-40 to +125	$^\circ\text{C}$

Operating Conditions at $T_a=25^\circ\text{C}$

Parameter	Symbol	Conditions	Ratings	Unit
Recommended operating voltage	V_{CC}		8.5	V
Operating voltage range	$V_{CC \text{ op}}$		6 to 14	V

LA1267

Operating Characteristics at $T_a=25^\circ\text{C}$, $V_{CC}=8.5\text{V}$, See specified Test Circuit

Parameter	Symbol	Conditions	Ratings			Unit
			min	typ	max	
[AM : $f=1\text{MHz}$]						
Quiescent current	I _{cco}	No input		18	26	mA
Detection output	V _{O1}	V _{IN} =20dB μ , 400Hz, 30% mod.	30	50	90	mV
	V _{O2}	V _{IN} =80dB μ , 400Hz, 30% mod.	110	160	220	mV
S/N	S/N1	V _{IN} =20dB μ	16	20		dB
	S/N2	V _{IN} =80dB μ	49	54		dB
Total harmonic distortion	THD1	V _{IN} =80dB μ , 400Hz, 30% mod.		0.3	1.0	%
	THD2	V _{IN} =107dB μ , 400Hz, 30% mod.		0.5	2.0	%
Signal meter output	V _{SM 1}	No input	0	0	0.2	V
	V _{SM 2}	V _{IN} =80dB μ	2.4	2.8	3.1	V
LED lighting sensitivity	V _{LED on}	I _{LED} =1mA	15	24	33	dB μ
Local OSC buffer output	V _{OSC}	f _{OSC} =1.45MHz	220	275	330	mV
[FM : $f=10.7\text{MHz}$]						
Quiescent current	I _{cco}	No input		20	28	mA
Input limiting sensitivity	-3dB _{L.S.}	3dB down, 400Hz, 100% mod.		31	37	dB μ
Demodulation output	V _O	V _{IN} =100dB μ , 400Hz, 100% mod.	240	330	460	mV
S/N	S/N	V _{IN} =100dB μ	78	84		dB
Total harmonic distortion	THD	V _{IN} =100%dB μ , 400Hz, 100% mod.		0.03	0.3	%
Signal meter output	V _{SM 1}	No input	0	0	0.2	V
	V _{SM 2}	V _{IN} =100dB μ	1.5	2.7	3.1	V
LED lighting sensitivity	LED-on	I _{LED} =1mA	35	50	65	dB μ
LED lighting bandwidth	LED-BW	V _{IN} =100dB, I _{LED} =1mA	90	120	160	kHz
AM rejection ratio	AMR	V _{IN} =100dB μ , FM=400Hz 100% mod. AM=1kHz 30% mod.	45	60		dB

Note : Be fully careful of dielectric breakdown.

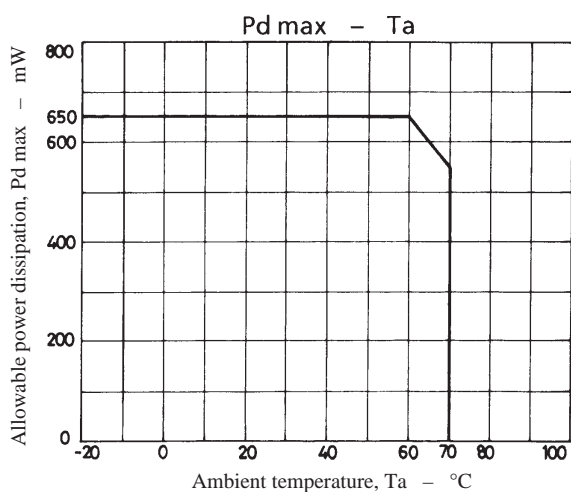

Equivalent Circuit Block Diagram

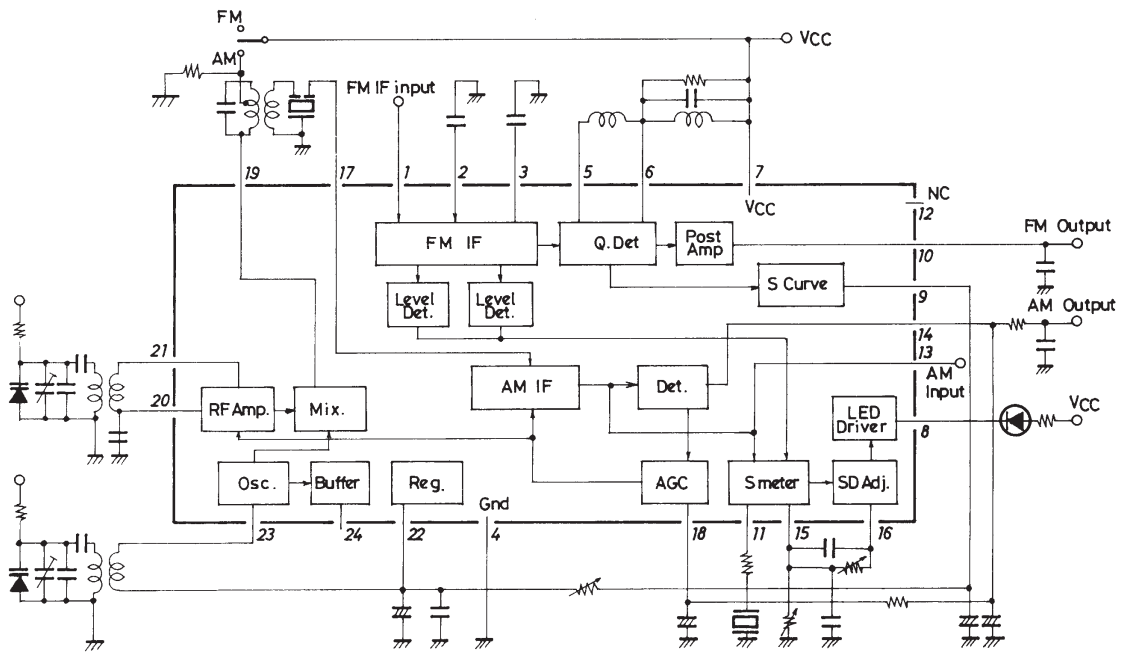

How to use the LA1267

1. LED lighting, muting drive output, stop signal (SD).

- For LED lighting, muting drive output, stop signal, the output at pin 8 is used.
- The voltage on pin 8, when tuned, turns from "H" to "L". (Active-Low)
- Signal bandwidth at pin 8.
 - For AM, the bandwidth depends on the CF (BFU450CN) at pin 11. If a capacitor is connected in place of the CF, the bandwidth will get wider.
 - For FM, the bandwidth depends on the resistance across pins 9 and 22. If the resistance is increased, the bandwidth will get narrower. $R=15k\Omega$ makes the bandwidth approximately 120kHz.

• Sensitivity adjustment of LED, muting, stop signal.

- For FM, the semifixed variable resistor across pin 15 and GND is used.
- For AM, the semifixed variable resistor across pins 15 and 16 is used. Be sure to start adjustment for FM, and then make adjustment for AM. For the stop signal sensitivity and FM stop signal bandwidth, the variations should be considered and it is recommended to use the semifixed variable resistor for adjustment.

• LED lighting sensitivity setting for AM.

For the LED lighting sensitivity setting for AM, it is desirable that the IC input be $30dB\mu$ (antenna input : approximately $50dB/m$). In this case, the value of VR1 is $30k\Omega$.

LED Lighting Bandwidth – Resistance across pins 9 and 22

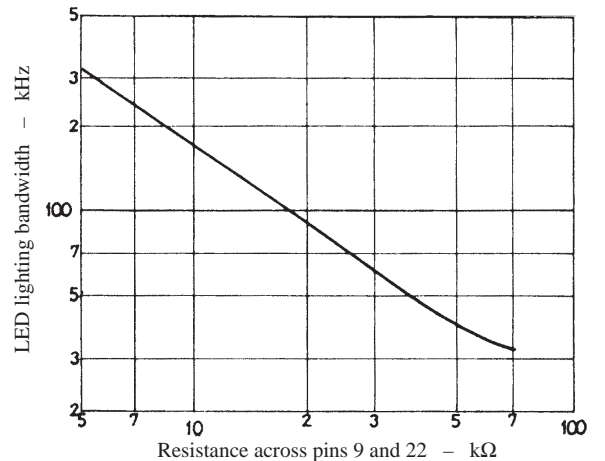

• LED lighting sensitivity setting for FM.

For the LED lighting sensitivity setting for FM, the IC input may be 45dBμ to 60dBμ. With the variations in the front end considered, it is ideal that the IC input in a standard receiving set be 51dBμ to 54dBμ. The lower value of VR2 for the LED lighting sensitivity setting is as illustrated right. Since the variations in the front end cause the IC input setting sensitivity to vary, it is recommended to use a value of VR2 at an input voltage lower than a standard setting by 6dB or greater. For example, if IC input 53dBμ is taken as a standard, use VR2 ≤ 100kΩ at IC input 47dBμ.

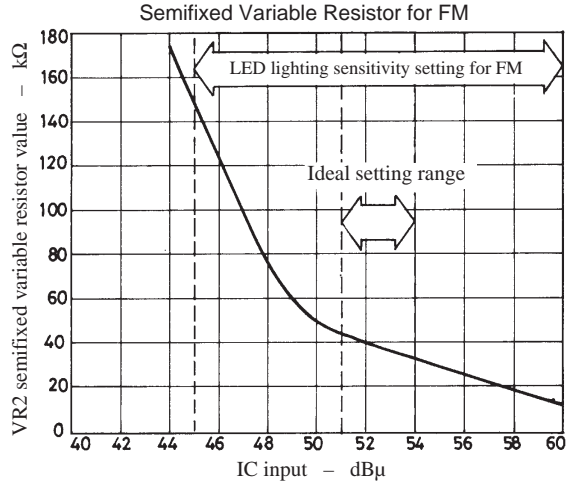

2. AM/FM changeover

• Two selections are available for changeover as shown below : (A) pin 19-used method and (B) pin 20-used method.

- For (A), the voltage on pin 19 relative to V_{CC} (pin 7) must be within the range of -0.8V to +0.1V. If not within this range, distortion and selectivity will get worse.
- For (A), a resistance of 68kΩ at the IFT cold terminal, which is used to prevent the changeover circuit from malfunctioning, must be connected.

(A) pin 19-use method for AM/FM changeover

(B) Pin 20-used method for AM/FM changeover

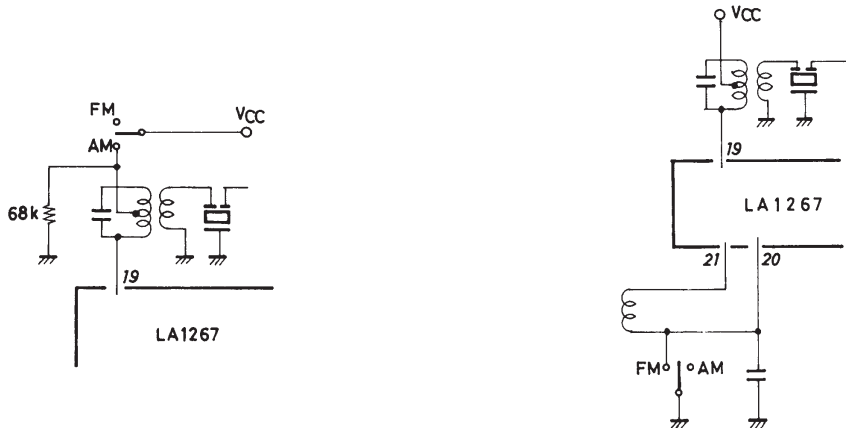

3. Local OSC buffer output

- When local OSC buffer output wave form is saw-toothed at the SW mode, connect a resistance of 1.2kΩ or thereabouts across pin 24 and GND.

4. AM input pin

- It is desirable that the AM input pin (pin 21) be L-coupled to pin 20.
- Inputting to pin 21 can be done by DC-cutting with a capacitor. However, an unbalance in the RF amplifier (differential amplifier) causes gain drop and whistle worsening.

5. Capacitance across pin 9 and GND.

A large capacitance across pin 9 and GND may cause a misstop at an adjacent channel when the channel select speed is made faster at the automatic channel select mode. In this case, decrease the capacitance across pin 9 and GND. However, if too decreased, the LED will flutter at low modulation frequencies at the time of detuning. Therefore, it is recommended to fix the capacitance across pin 9 and GND to be 3.3μF to 10μF. The relation between modulation frequency and demodulation output voltage on pin 9 with the capacitance across pin 9 and GND as a parameter is shown right.

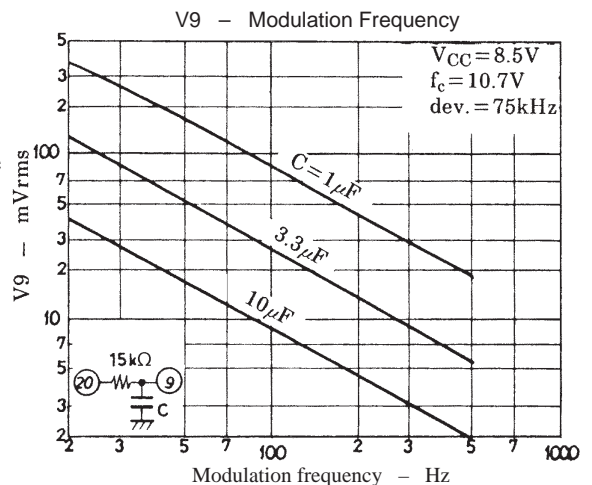

LA1267

6. If the coupling coefficient of the local OSC coil is small and an antiresonance point of approximately 100MHz is present or the stray capacitance across pins 24 and 23 is large, a parasitic oscillation of approximately 100MHz may occur in the buffer output (pin 24). In this case, connect a capacitance of approximately 30pF across pin 24 and GND.
7. AM OSC coil
Generally speaking, the following should be noted. Avoid winding with loose coupling between primary side and secondary side (especially SW1, SW2). To put it concretely, the pot core type is better than the screw core type which is loose in coupling. This prevents the local OSC frequency from turning third resonance frequency related to the coupling coefficient.
8. Resistance across pin 8 and V_{DD} .
If pin 8 is used for the stop signal (SD) only, without using LED, it is recommended to fix resistance R_L across pin 8 and GND to be 51k Ω to 100k Ω .
9. To prevent whistle from worsening, make the pattern of AM output pin 14 as short as possible.

Input/Output Admittance

FM

—	Parameter	Frequency	—	Admittance	Unit
IF	γ_{i1}	10.7MHz	r_i	330	Ω
			c_i	20	pF

AM

—	Parameter	Frequency	—	Admittance		Unit
				AGC-off ($V_{16}=1.4V$)	AGC-on ($V_{16}=2.5V$)	
RF	γ_{i21}	1MHz	r_i	15	16	k Ω
			c_i	4	4	pF
MIX	γ_{o19}	500kHz	r_o	—	—	k Ω
			c_o	3	3	pF
IF	γ_{i17}	500kHz	r_i	2	2	k Ω
			c_o	10	8	pF

Test Circuit : FM, AM-MW

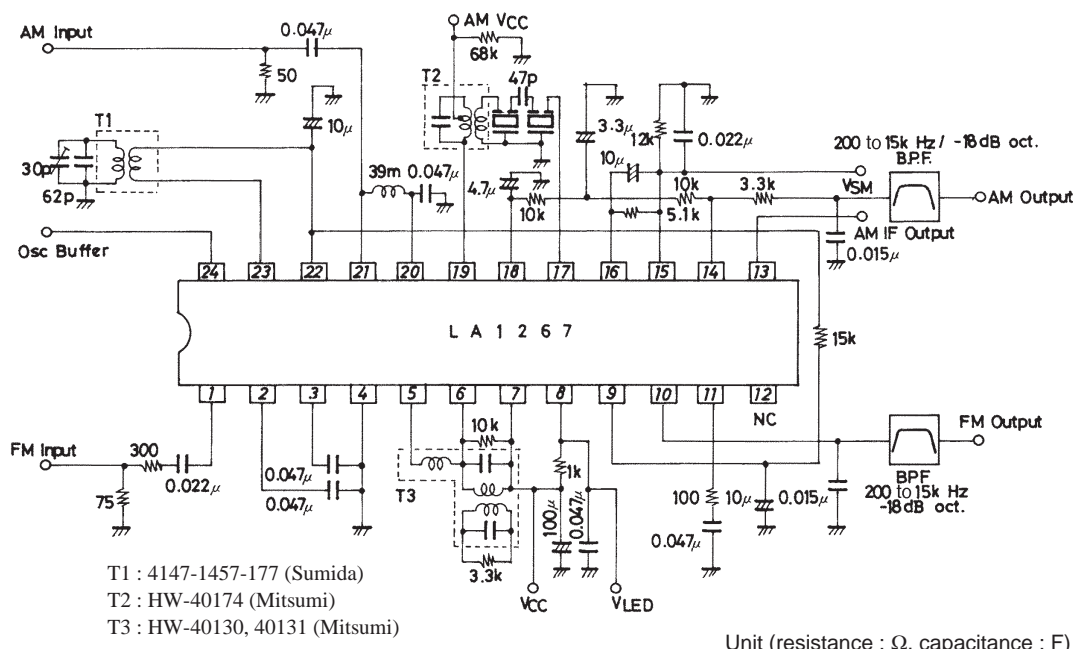

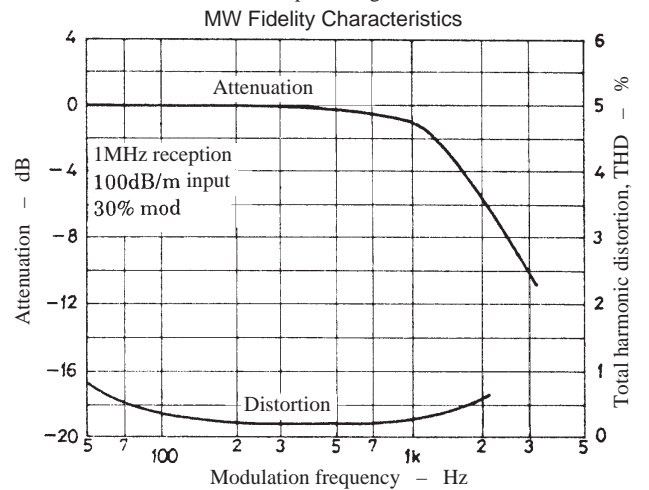
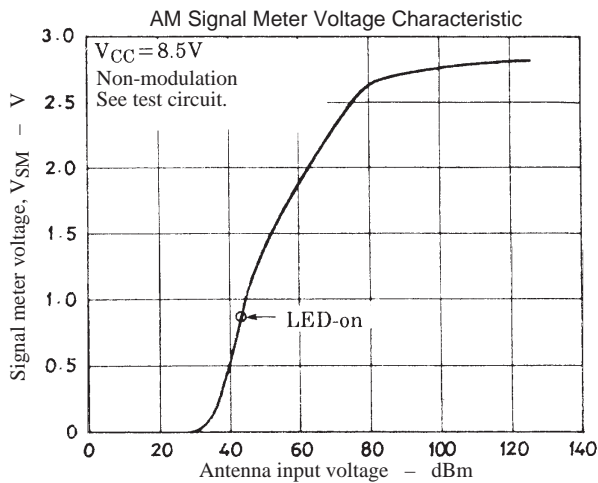
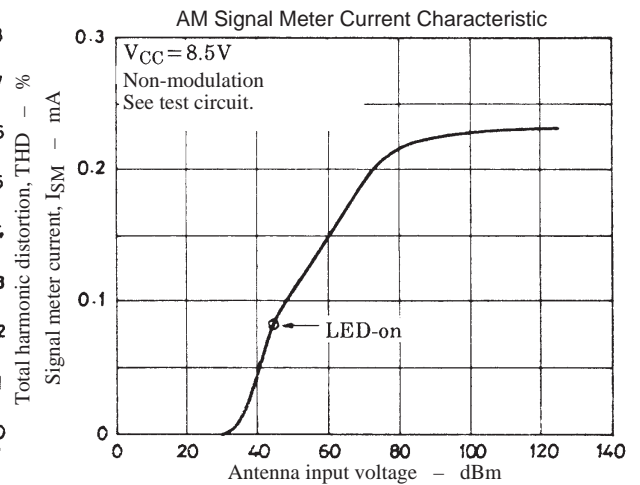
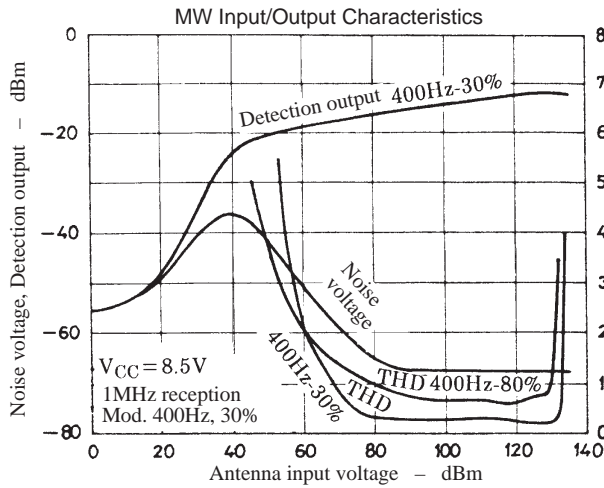
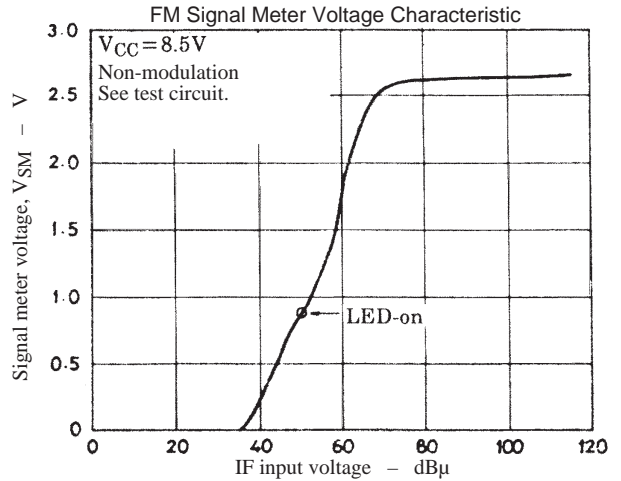
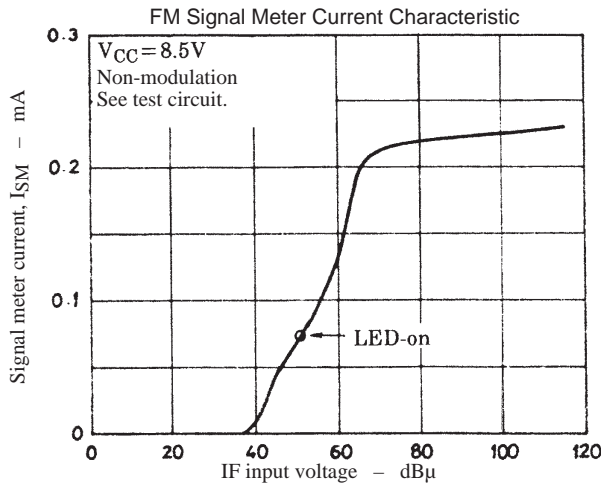
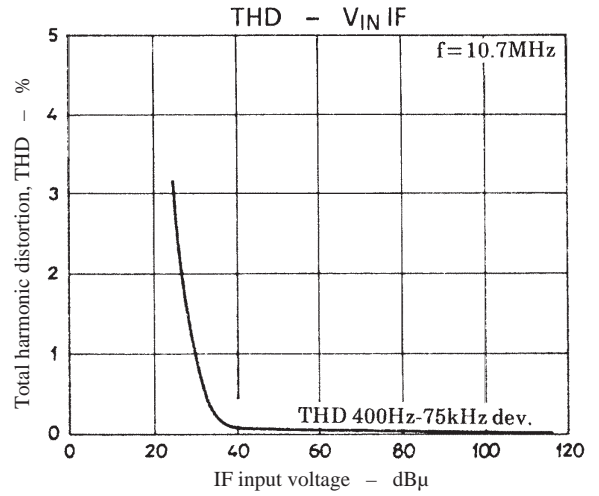
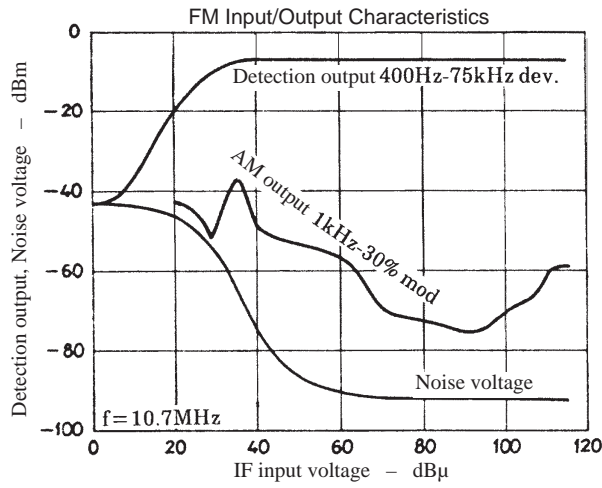

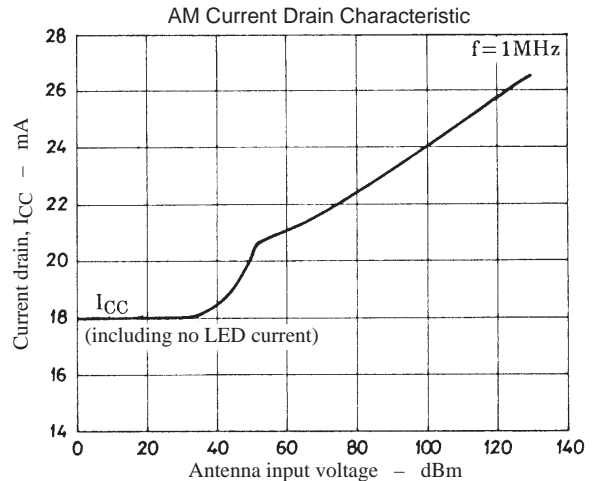
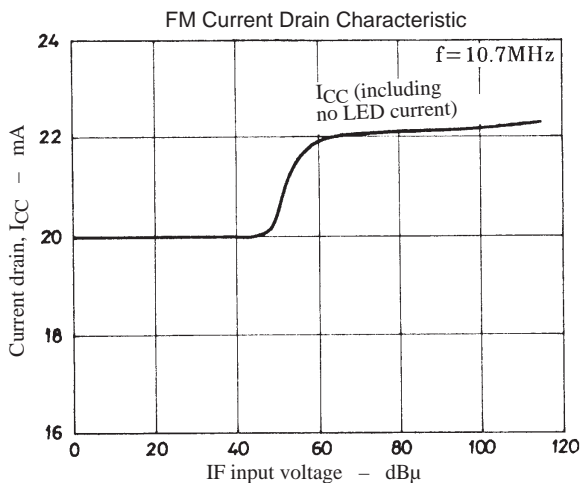
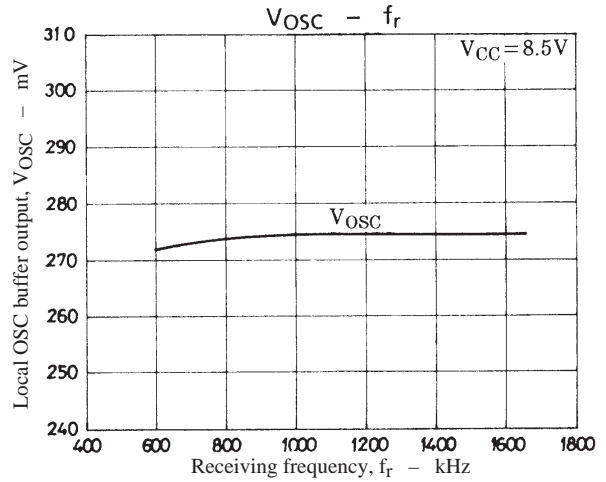
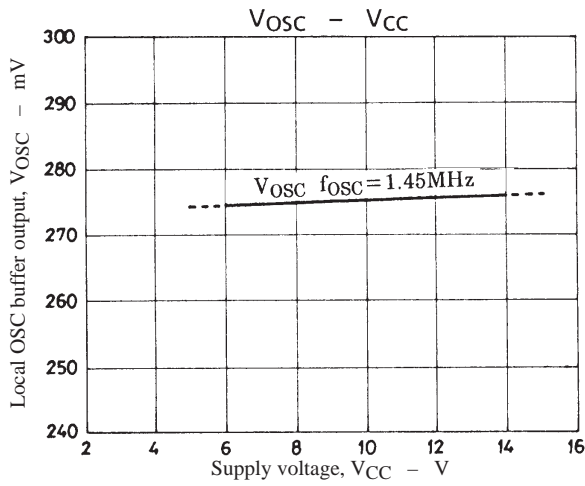
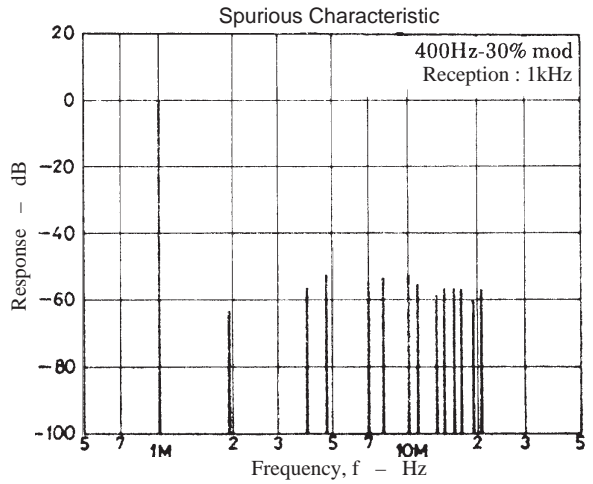
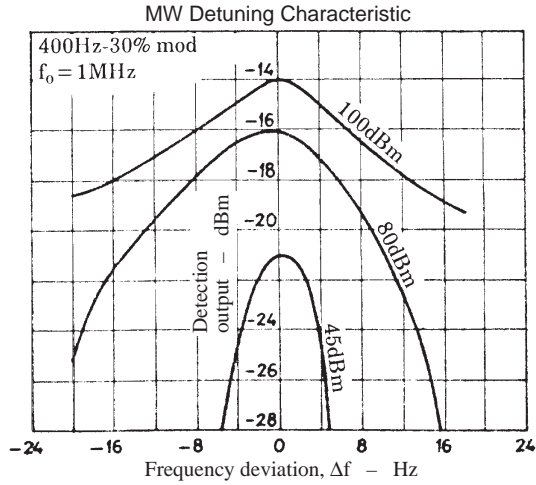
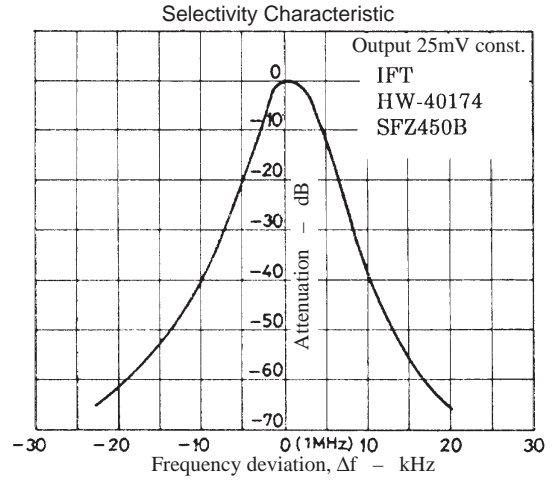
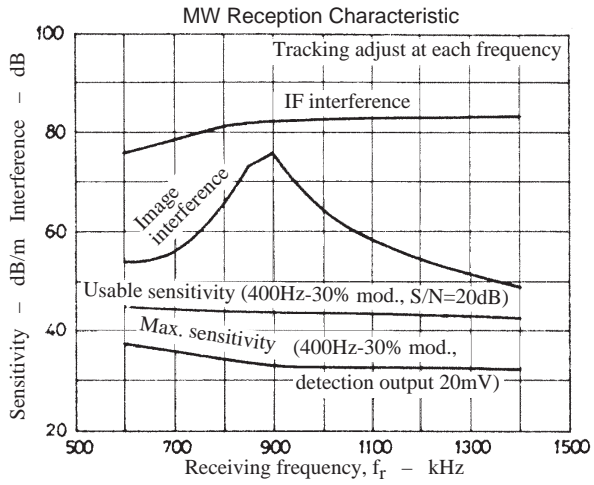

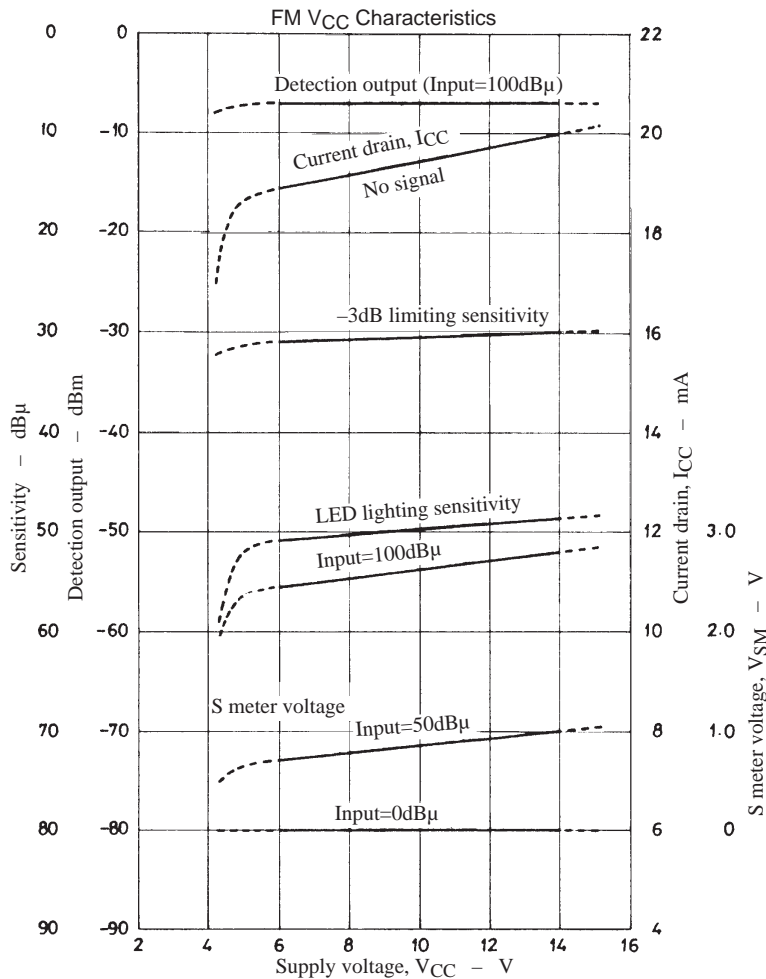
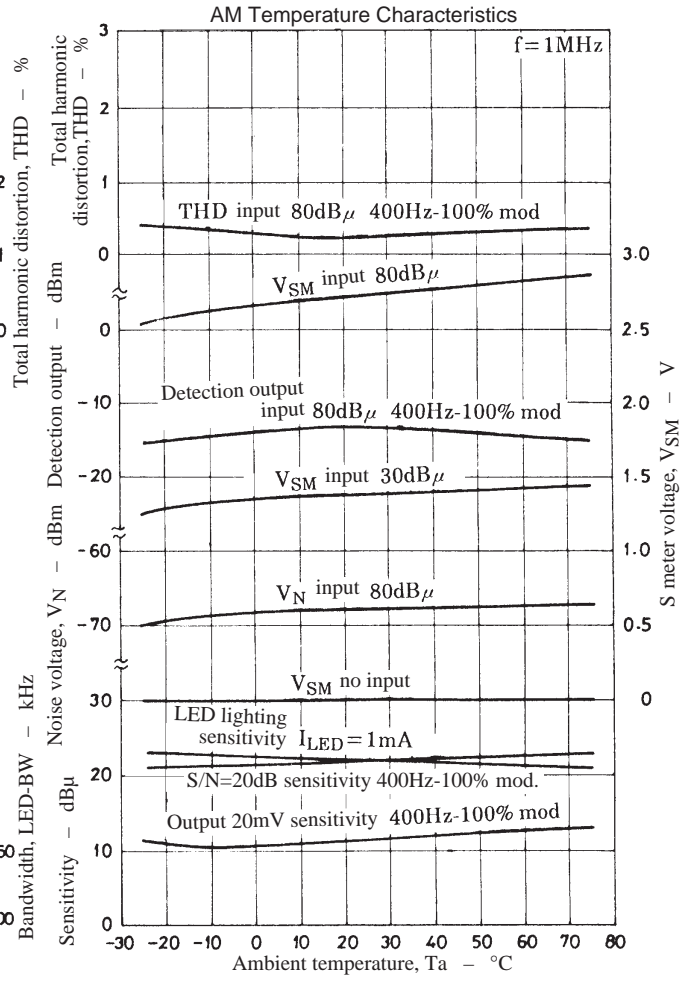
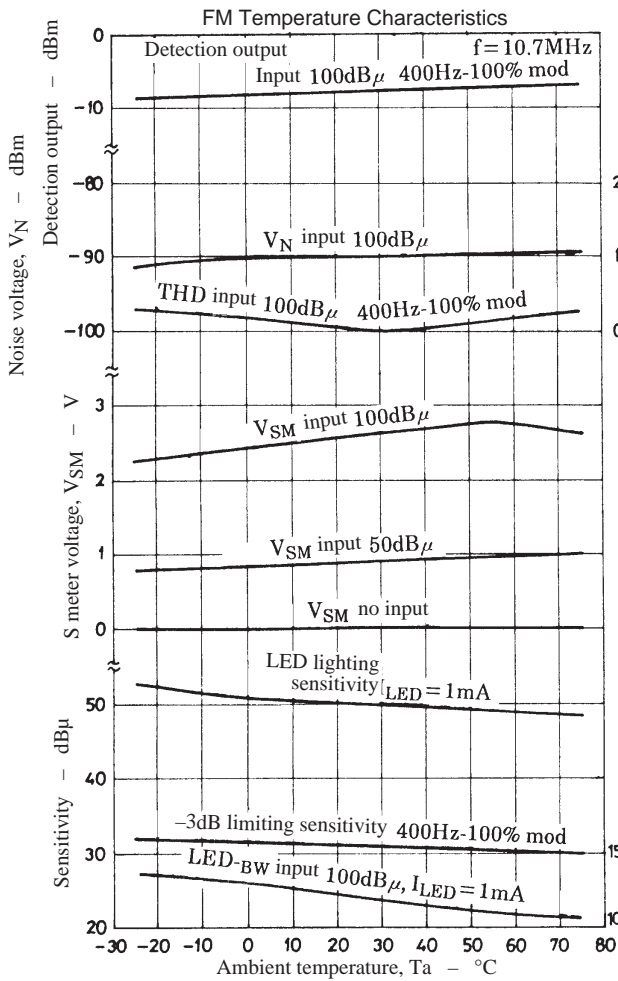

LA1267

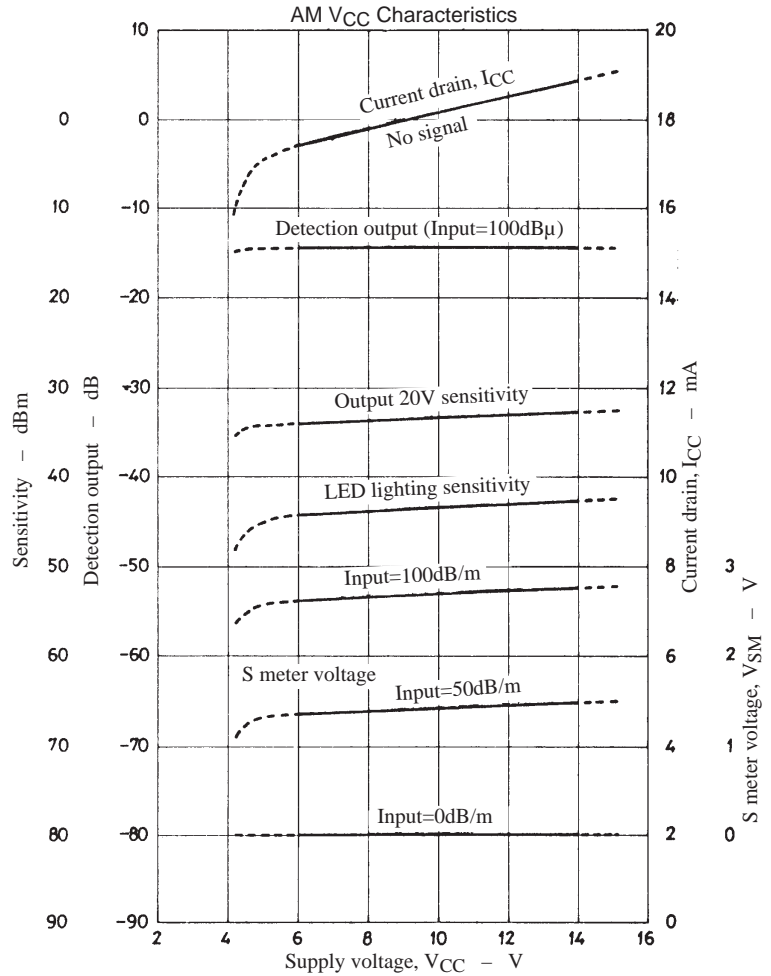

Test Circuit : SW2

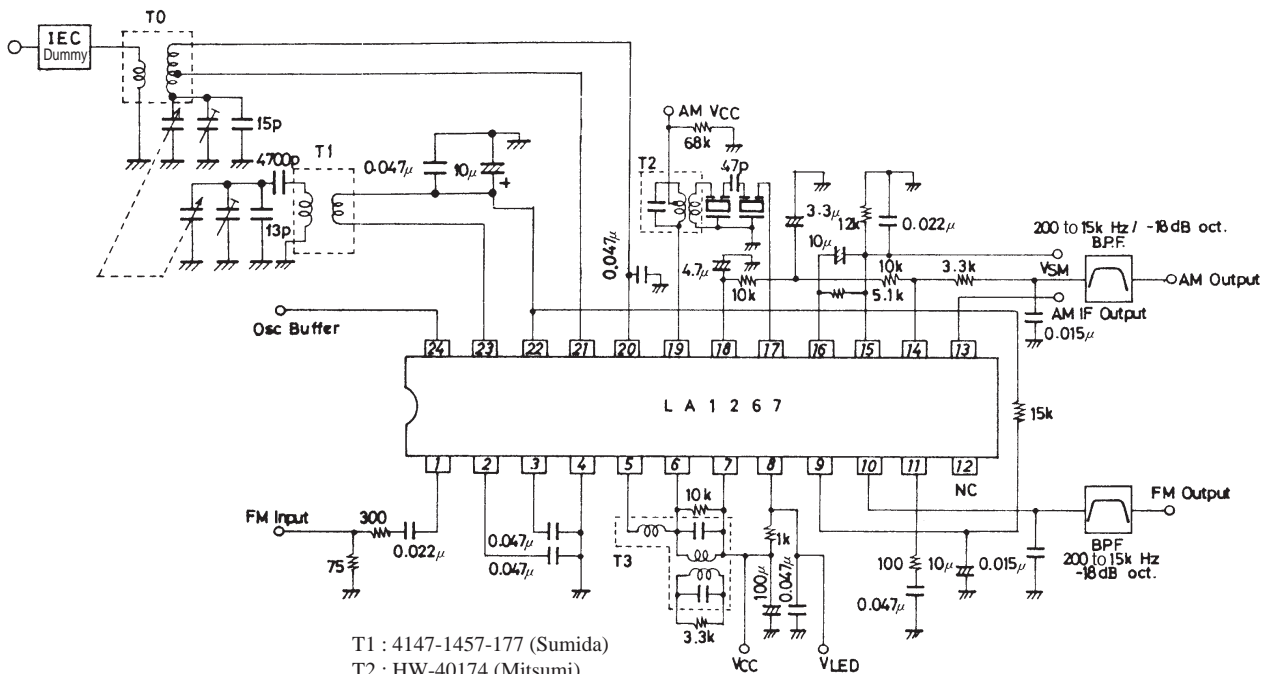

- T1 : 4147-1457-177 (Sumida)
- T2 : HW-40174 (Mitsumi)
- T3 : HW-40130, 40131 (Mitsumi)

Unit (resistance : Ω , capacitance : F)

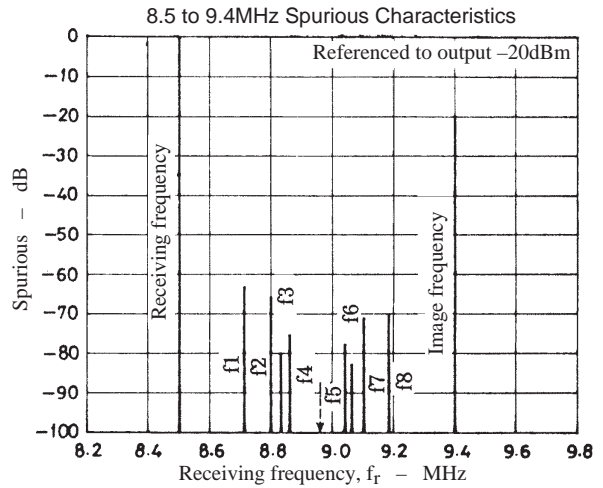
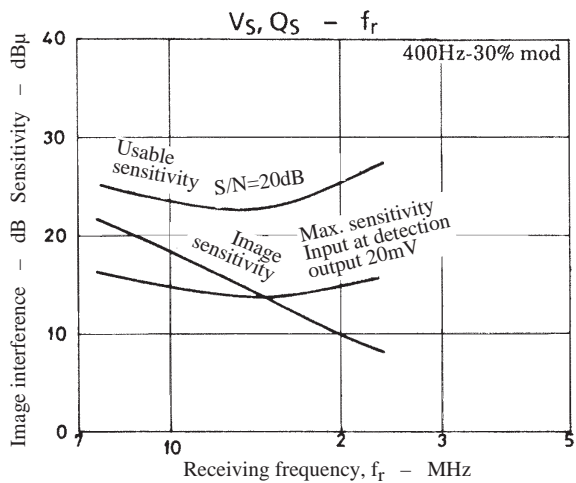
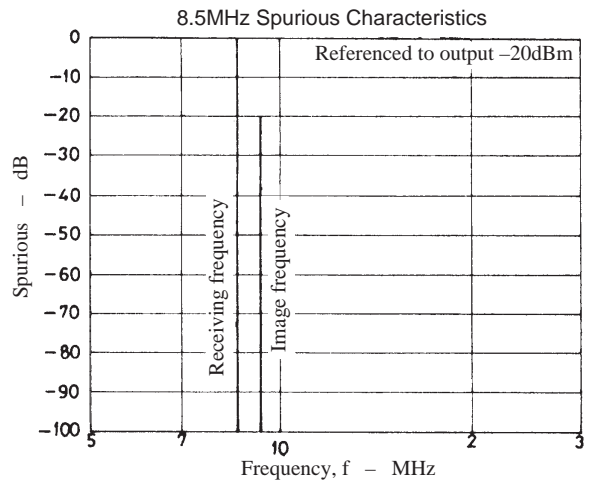
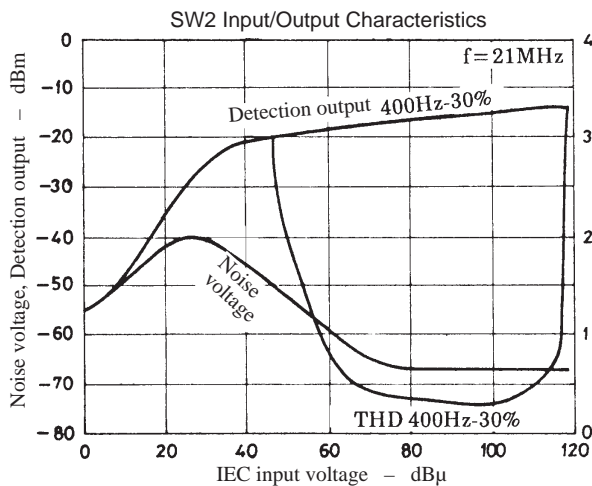
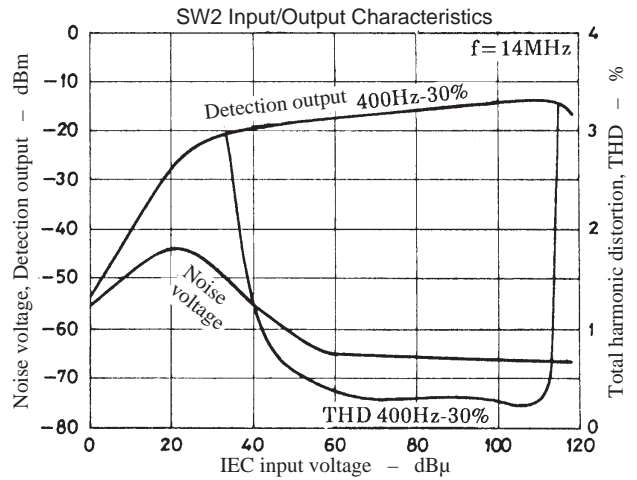
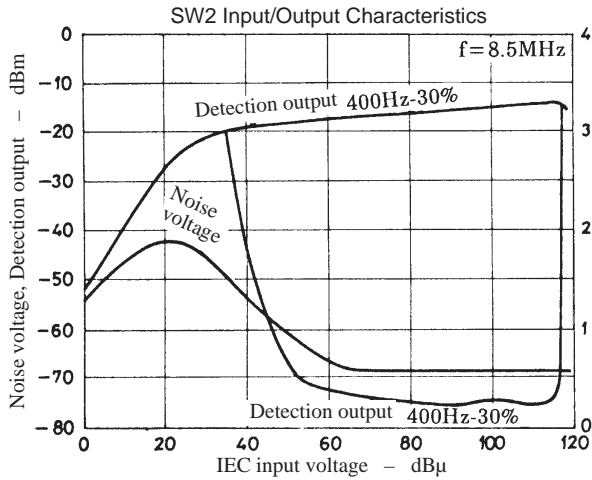

- f1 : 8.724MHz → 2f_{OSC}-2f1 = 455kHz
- f2 : 8.799MHz → 3f_{OSC}-3f2 = 455kHz
- f3 : 8.836MHz → 4f_{OSC}-4f3 = 455kHz
- f4 : 8.859MHz → 5f_{OSC}-5f4 = 455kHz
- f5 : 9.038MHz → 5f5-5f_{OSC} = 455kHz
- f6 : 9.061MHz → 4f6-4f_{OSC} = 455kHz
- f7 : 9.098MHz → 3f7-3f_{OSC} = 455kHz
- f8 : 9.173MHz → 2f8-2f_{OSC} = 455kHz

Coil Specifications

MW antenna

Bar antenna (for PVC22KTL)

- TN-10896 (Mitsumi)

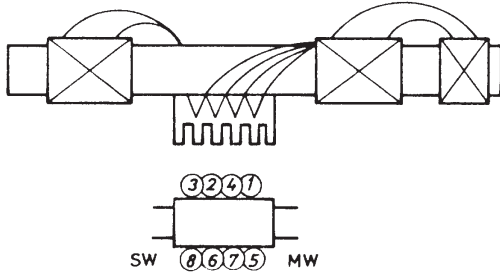

- ①-② 22T + 49T, ③-④ 10T
- Tight solenoid direct winding
- ⑤-⑥ 17T 0.5φ space winding
- ⑦-⑧ 4T tight solenoid winding
- ①-② $L = 260\mu\text{H}$, $Q_0 = 330 (\geq 200)$
- ⑤-⑥ $L = 15\mu\text{H}$, $Q_0 = 250 (\geq 150)$

Loop antenna (for SVC321)

- LA300 (Korin Giken)

Loop antenna matching coil

- KT-412

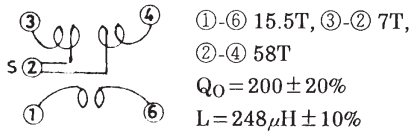

- ①-⑥ 15.5T, ③-② 7T,
- ②-④ 58T
- $Q_0 = 200 \pm 20\%$
- $L = 248\mu\text{H} \pm 10\%$

MW OSC

- 4147-1457-177 (Sumida)

For PVC22KTL

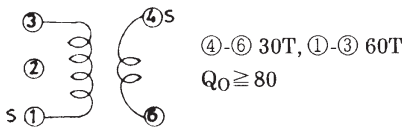

- ④-⑥ 30T, ①-③ 60T
- $Q_0 \geq 80$

- KO-387 (Korin Giken)

For SVC321

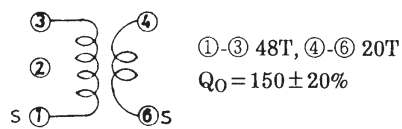

- ①-③ 48T, ④-⑥ 20T
- $Q_0 = 150 \pm 20\%$

AM-IFT

Matching coil for SFU450B (1-element type)

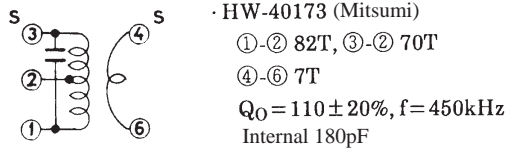

- HW-40173 (Mitsumi)
- ①-② 82T, ③-② 70T
- ④-⑥ 7T
- $Q_0 = 110 \pm 20\%$, $f = 450\text{kHz}$
- Internal 180pF

- 2150-2162-197 (Sumida)
- ①-② 103T, ③-② 71T,
- ④-⑥ 8T
- $Q_0 \geq 80$, $f = 450\text{kHz}$
- Internal 180pF

Matching coil for SFZ450B (2-element type)

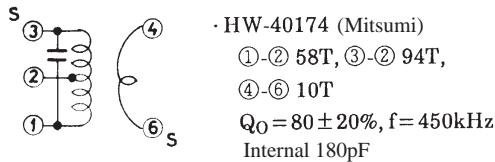

- HW-40174 (Mitsumi)
- ①-② 58T, ③-② 94T,
- ④-⑥ 10T
- $Q_0 = 80 \pm 20\%$, $f = 450\text{kHz}$
- Internal 180pF

- 2150-2061-049 (Sumida)
- ①-② 54T, ③-② 120T,
- ④-⑥ 12T
- $Q_0 \geq 40$
- Internal 180pF

FM single tuning detection coil

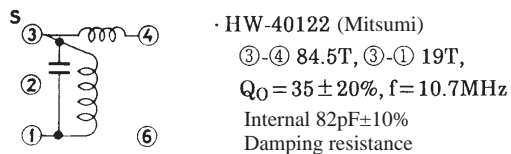

- HW-40122 (Mitsumi)
- ③-④ 84.5T, ③-① 19T,
- $Q_0 = 35 \pm 20\%$, $f = 10.7\text{MHz}$
- Internal 82pF $\pm 10\%$
- Damping resistance

- 2231-016 (Sumida)
- ③-④ 73.5T, ③-① 19T,
- $Q_0 = 30 \pm 20\%$, $f = 10.7\text{MHz}$
- Internal 82pF $\pm 10\%$
- Damping resistance

FM double tuning detection coil

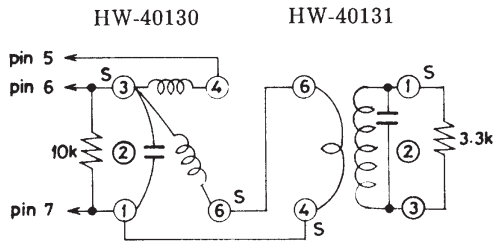

- HW-40130 (Mitsumi)
 - ③-④ 86.5T
 - ③-⑥ 13.5T
 - $Q_0 = 50 \pm 20\%$
 - Internal 100pF $\pm 10\%$

- HW-40131 (Mitsumi)
 - ④-⑥ 1T
 - ①-③ 19T
 - $Q_0 = 35 \pm 20\%$
 - Internal 100pF $\pm 10\%$

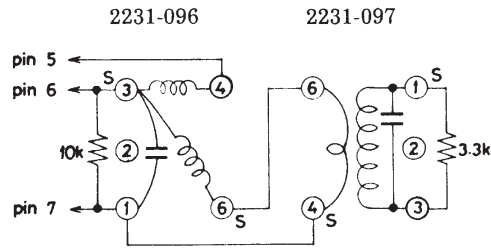

- 2231-096 (Sumida)
 - ③-④ 73.5T
 - ③-⑥ 23.5T
 - $Q_0 = 50 \pm 20\%$
 - Internal 62pF $\pm 10\%$

- 2231-097 (Sumida)
 - ④-⑥ 2T
 - ①-③ 21T
 - $Q_0 = 47 \pm 20\%$
 - Internal 82pF $\pm 10\%$

Unit (resistance : Ω)

Sample Application Circuit : LA1186N + LA1265 (US Band)

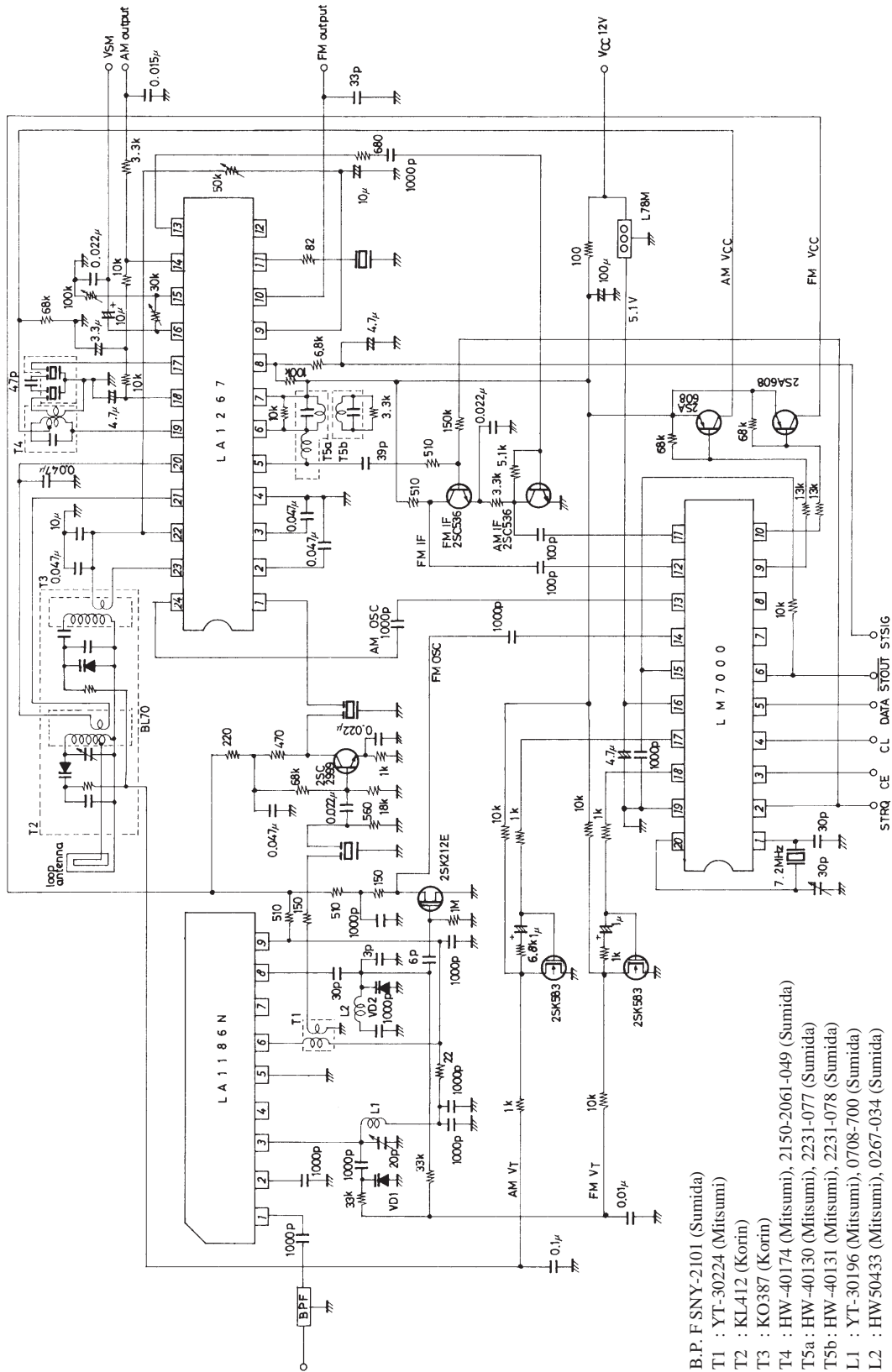

- B.P.F SNY-2101 (Sumida)
- T1 : YT-30224 (Mitsumi)
- T2 : KL412 (Korin)
- T3 : KO387 (Korin)
- T4 : HW-40174 (Mitsumi), 2150-2061-049 (Sumida)
- T5a : HW-40130 (Mitsumi), 2231-077 (Sumida)
- T5b : HW-40131 (Mitsumi), 2231-078 (Sumida)
- L1 : YT-30196 (Mitsumi), 0708-700 (Sumida)
- L2 : HW50433 (Mitsumi), 0267-034 (Sumida)

Unit (resistance : Ω, capacitance : F)

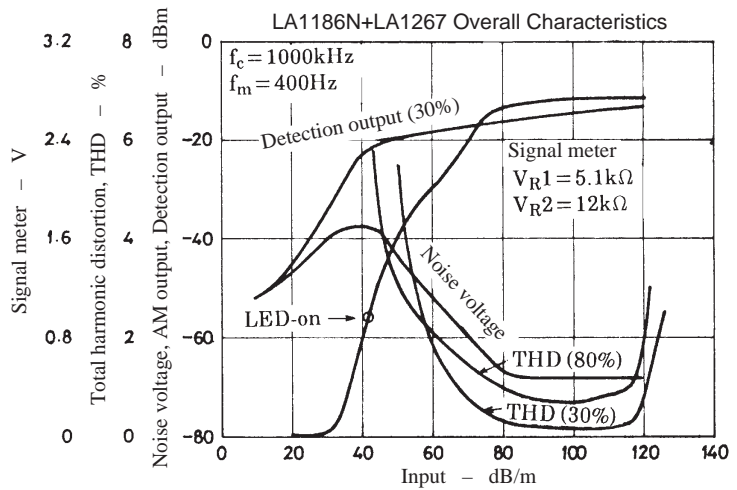
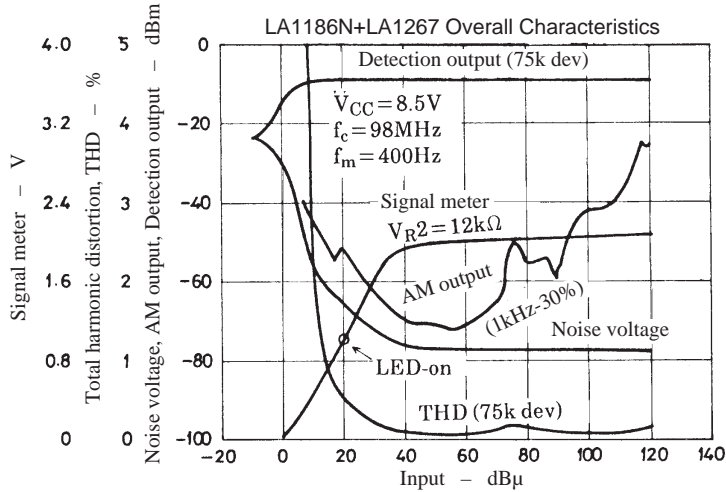

- No products described or contained herein are intended for use in surgical implants, life-support systems, aerospace equipment, nuclear power control systems, vehicles, disaster/crime-prevention equipment and the like, the failure of which may directly or indirectly cause injury, death or property loss.
- Anyone purchasing any products described or contained herein for an above-mentioned use shall:
 - ① Accept full responsibility and indemnify and defend SANYO ELECTRIC CO., LTD., its affiliates, subsidiaries and distributors and all their officers and employees, jointly and severally, against any and all claims and litigation and all damages, cost and expenses associated with such use:
 - ② Not impose any responsibility for any fault or negligence which may be cited in any such claim or litigation on SANYO ELECTRIC CO., LTD., its affiliates, subsidiaries and distributors or any of their officers and employees jointly or severally.
- Information (including circuit diagrams and circuit parameters) herein is for example only; it is not guaranteed for volume production. SANYO believes information herein is accurate and reliable, but no guarantees are made or implied regarding its use or any infringements of intellectual property rights or other rights of third parties.

This catalog provides information as of November, 1997. Specifications and information herein are subject to change without notice.