

**LA1245****AM Electronic Tuner****Overview**

LA1245 is a high performance IC to be used as an AM electronic tuner. It provides an automatic search-stop signal, local oscillator buffer-output, and the low level local oscillation, as well as providing all other functions required of an AM tuner. Moreover, the stable local oscillation from LW to SW facilitates the use of many band.

Functions

- RF amplifier • MIX • OSC (with ALC) • Detection
- IF amplifier • AGC • Local oscillation buffer-output
- Signal meter driving output (also used as an automatic search stop-signal)
- etc.

Features

- | | |
|--|---|
| <ul style="list-style-type: none"> • Narrow-band signal meter • Local oscillation buffer-output • OSC (with ALC) • RF amplifier • MIX • Low noise • Compensation for V_{CC} fluctuation • Low shock noise | <ul style="list-style-type: none"> : Available as an automatic search-stop signal (also available as a wide-band signal meter). Signal meter output=1/2 frequency $\pm 1.5\text{kHz}$ typ. : Facilitates the design of electronic tuning systems and frequency representation. : The oscillation output is stabilized at a low level (350 mVrms) for a varactor diode, and tracking error is minimized. : Excellent in usable sensitivity by incorporating low-noise transistors in cascode circuit (45dB/m typ). : Double balanced differential MIX prevents the influence of spurious radiation and IF interferences (IF interference = 85dB typ). : Excellent in S/N for intermediate input (57dB typ). : Allows little gain fluctuation and little distortion fluctuation (8 to 16 V). : Able to decrease the shock noise by selecting AGC time constant when changing V_{CC}-on and/or switching the mode. |
|--|---|

Package Dimensions

unit : mm

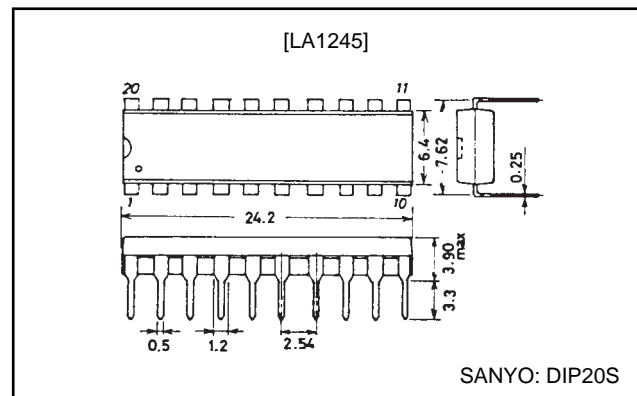
3021B-DIP20S

LA1245

Specifications

Maximum Ratings at Ta=25°C

Parameter	Symbol	Conditions	Ratings	Unit
Supply voltage	V _{CCmax}	Pin 8, 14	16	V
Output voltage	V _O	Pin 5, 7	24	V
Input voltage	V _I	Pin 3	5.6	V
Supply current	I _{CCmax}	Pin 5+7+8+14	32	mA
Output high drive current	I ₁₈	Pin 18	5	mA
	I ₂₀	Pin 20	2	mA
Allowable power dissipation	Pd max	See Figure 2	700	mA
Operating temperature	T _{opr}		-20 to +70	°C
Storage temperature	T _{stg}		-40 to +125	°C

Recommended Operating Conditions at Ta=25°C

Parameter	Symbol	Conditions	Ratings	Unit
Recommended supply voltage	V _{CC}		12	V

Operating Characteristics at Ta=25°C, V_{CC}=12V, f_r=1MHz, f_m=400Hz, at specified test circuit (based on application circuit).

Parameter	Symbol	Conditions	Ratings			Unit
			min	typ	max	
Current drain	I _{CC1}	quiescent	16.0	25.0	35.0	mA
	I _{CC2}	107 dBμ input	19.0	29.0	40.0	mA
Detection output	V _{O1}	23 dBμ input, mod. 30%	-27.5	-23.0	-18.5	dBm
	V _{O2}	80 dBμ input, mod. 30%	-15.5	-12.5	-9.5	dBm
Signal to noise ratio	S/N1	23 dBμ input, mod. 30%	16	20		dB
	S/N2	80 dBμ input, mod. 30%	52	57		dB
Total harmonic distortion	THD1	80 dBμ input, mod. 30%		0.4	1.0	%
	THD2	107 dBμ input, mod. 30%		0.3	1.0	%
Signal meter output	V _{SM1}	quiescent		0	0.5	V
	V _{SM3}	107 dBμ input	3.0	4.5	7.0	V
Input at signal meter output=1V	V _{IN1}	V _{SM} output=1V	19.0	25.0	31.0	dBμ
Local oscillation-buffer output	V _{osc}		250	350		mVrms

Reference Characteristics

Parameter	Symbol	Conditions	Ratings			Unit
			min	typ	max	
Signal meter output	V _{SM2}	40 dBμ input		2.5		V
Total harmonic distortion	THD3	112 dBμ input, mod.30%		2		%
Local oscillation fluctuation within a band	ΔV _{osc}	V _{oscL} (522kHz) to V _{oscH} (1647kHz)		10		mVrms
Signal meter band width*	V _{SM-BW1}	80 dBμ input, 1/2 output frequency		±1.5		kHz
	V _{SM-BW2}	80 dBμ input, 1/10 output frequency		-4.5/+7		kHz
Selectivity		±10kHz at 30% mod.		45		dB
IF interference		f _r =600kHz		85		dB
Image frequency interference ratio		f _r =1400kHz		40		dB

* BFB450C4 N (Murata, Co.) was used as a narrow band filter.

(Note) 0 dBm=775mV, 0 dBu=1μV.

Using the automatic search-stop signal

Signal Meter-driving output circuit is equivalent to Figure. 1, signal meter driving output (abbreviated as V_{SM}) is narrowed in band width and can be used as an automatic search-stop signal when a narrow band series resonator is connected to pin 15. V_{SM} can be adjusted with R_{208} and R_{211} both in wide band and narrow band since R_{208} is inversely proportional to V_{SM} , while R_{211} is proportional to V_{SM} . R_{208} is related to the Q of narrow band signal meter. When the resistance of R_{208} is increased, the Q will be damped and the band width increased. On the other hand, R_{211} used as the output impedance of V_{SM} and affects the cut-off frequency and time constant of low pass filter for V_{SM} and the meter drive impedance. The time constant τ and the cut-off frequency f_c can be expressed as follows :

$$\begin{cases} \tau = (C_{114} + C_{115} + C_S) (R_{211} / R_{in}) \\ f_c = \frac{1}{2\pi\tau} \end{cases}$$

A semi-fixed resistor is recommended to be used as R_{211} to cope with the fluctuation of V_{SM} . Refer to Figure. 3 for the value of the semi-fixed resistor since this depends upon V_{SM} and R_{208} . Figure. 3 shows the lowest limit of the semi-fixed resistor in relation to R_{208} with the parameter of V_{SM} set point, and the value of the semi-fixed resistor will be equal to or greater than that shown in Figure. 3. For example, when $V_{SM}=5V$ and $R_{208}=240\Omega$, R_{211} becomes 28k Ω . Thus, the value of the semi-fixed resistor is determined to be about 30k Ω . When the value of V_{SM} is too large, it is limited and saturated to the source voltage so it is recommended to follow the condition of $V_{SM} \leq V_{CC} - 2(V)$. When a narrow band serial resonator is used, include the resonant impedance to determine the value of R_{208} .

Figure . 1 Signal Meter Detector Circuit

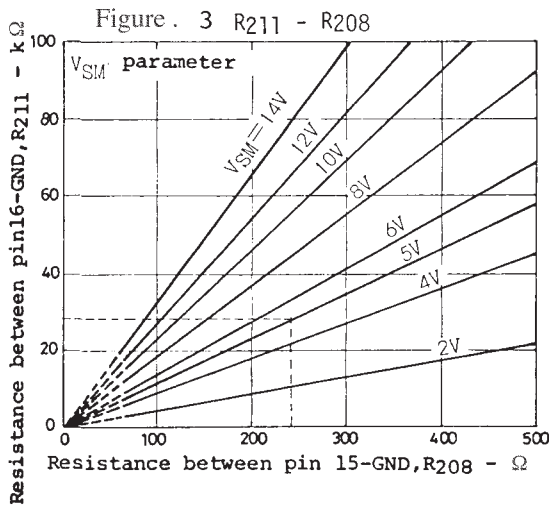
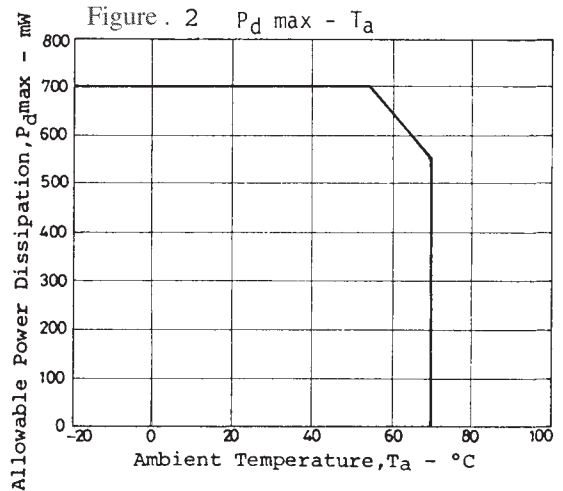
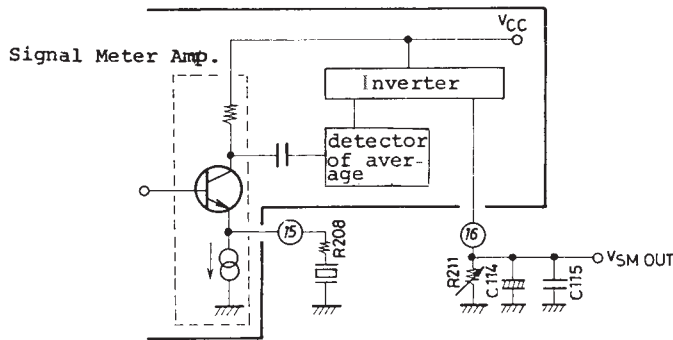

Input/Output Admittance

	Parameter	Frequency		AGC-off	AGC-on
RF	y _{i3}	1 MHz	r _i	8 k Ω	40 k Ω
	y _{o5}	1 MHz	c _i	30 pF	13 pF
MIX	y _{i6}	1 MHz	r _o	—	—
	y _{o7}	500 kHz	c _o	4 pF	—
1st IF	y _{i9}	500 kHz	r _i	10 k Ω	—
	y _{o10}	500 kHz	c _i	2.6 pF	—
2nd IF	y _{i11}	500 kHz	r _o	— k Ω	—
			c _o	2 pF	—
			r _i	3 k Ω	3.2 k Ω
			c _i	7 pF	3 pF
			r _o	45 Ω	42 Ω
			c _o	20 pF	20 pF
			r _i	80 Ω	—
			c _i	—150 pF	—

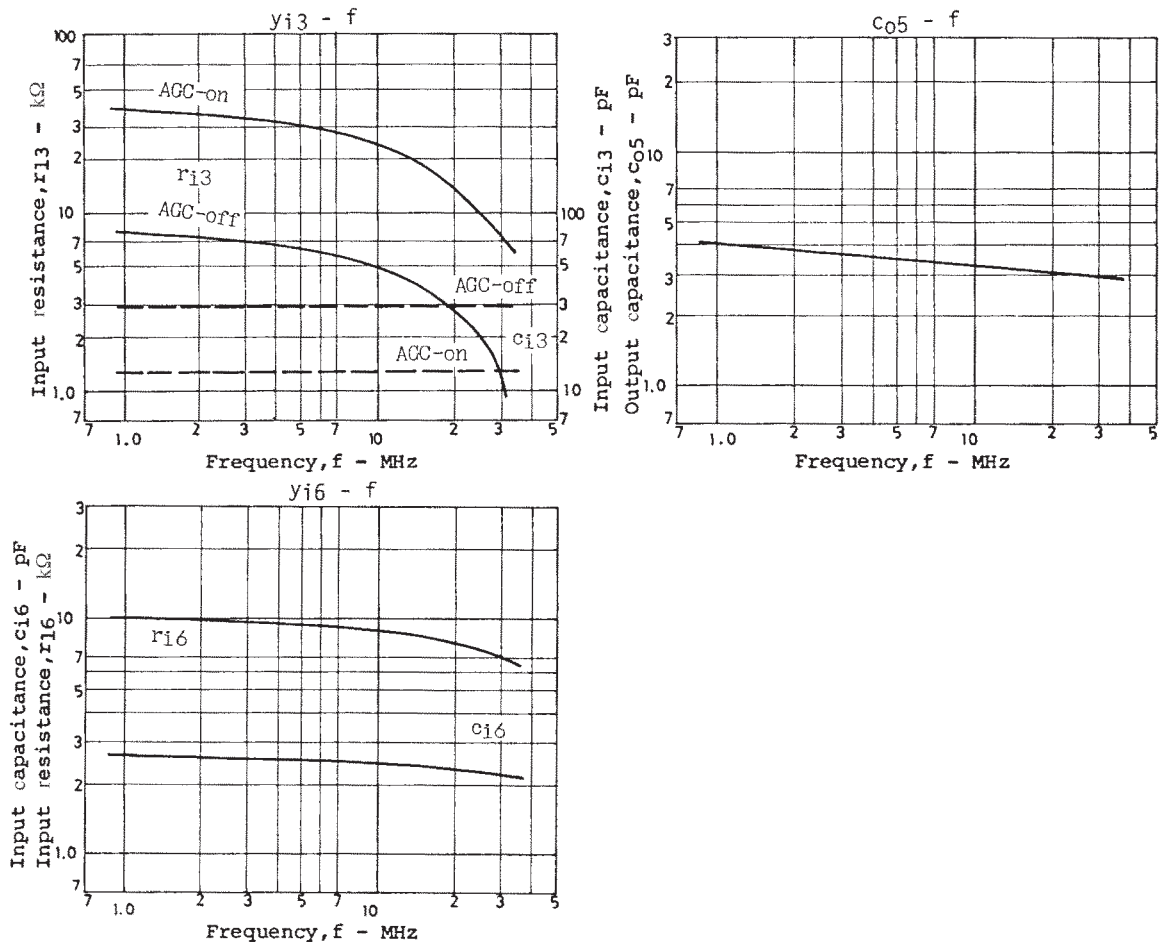

Notes on LA1245 usage

1. When suddenly tuned to a broadcasting station of intermediate or high field strength, a large current of high frequency flows into the signal meter circuit, causing the local oscillator malfunctions and abnormal noises.

To eliminate this :

- Use $R_{208} \geq 240\Omega$ for manual tuning type.
 - Use $R_{208} \geq 82\Omega$, and use the local oscillation coil at the 1/3 tap (except SW) for electronic tuning type (which uses a narrow band filter).
2. Use the bias on the condition $RF V_{CC} \leq IF V_{CC}$, since abnormal noise levels might be caused when detuning a strong input on the condition $RF V_{CC} > IF V_{CC}$.
 3. Use the signal meter driving output (V_{SM}) at $V_{SM} \leq V_{CC} - 2$ (V) to avoid saturation caused by V_{CC} .
 4. Use 1/2 or more tap of LW and MW oscillation coil to improve S/N and the detuning characteristics of the distortion ratio.
 5. Use the full-tap of SW oscillation coil, to allow the sag in oscillation power by the decreasing of Q.
 6. Avoid the coupling of the antenna tuning circuit and the local oscillating circuit so as not to leak the local oscillation into the antenna tuning circuit.
 7. Connect the detection capacitor C_{113} between pin 13 (output) and pin 14 (V_{CC}) to avoid the leakage of the IF signal into the GND line. Connection between pin 13 and pin 12 (GND) increases the tweet interference and deteriorates the usable sensitivity.

Moreover, depending on the positions of C_{113} and the bar antenna, higher harmonics having twice or three times the frequency of the IF signal may pass into the antenna and cause tweet interference, and in extreme cases oscillation might be cause. To prevent this :

- Shorter lead wires and connect them near 13 and 14 pins.
- Place C_{113} far from the antenna.

8. When a cable or something similar is connected to a local oscillation buffer (pin 20), which is equivalent to connecting a capacitor of about 20pF, the output from the buffer will be of sawtooth waves, causing the level low at the short wave band. To prevent this, connect a resistor between pin 20 and GND, which will increase the operating current of the buffer amplifier. Since the maximum current obtained from pin 20 is 2mA, the suitable resistance between pin 20 and GND is 1.5kΩ.
9. Use a semi-fixed resistor for R₂₁₁ to allow the fluctuation of V_{SM}.
10. When changing an IFT or using an RF tuner, select a filter and related circuits according to the following conditions. The input levels of each terminal where 30% modulated detection output of -25dBm is obtained are as follows :

Pin 11 input	when R _g =520Ω (470Ω + 50Ω)	75dBμ
Pin 9 input	when R _g =50Ω	53dBμ
Pin 6 input	when R _g =50Ω	48dBμ
Pin 3 input	when R _g =50Ω	22dBμ

Slight change in IFT, however, will be covered by changing the constant of resistors R₂₀₂ and R₂₀₄.

11. When the coupling coefficient of the local oscillation coil is small and an anti-resonance point of about 100MHz is present or the stray capacitance between pin 19 and pin 20 is large, the buffer output (pin 20) may be subject to parasitic oscillation of about 100MHz. In this case, connect a capacitor of about 30pF between pin 20 and GND. To observe parasitic oscillation, connect a capacitor of 5pF in series with the probe. If the probe is connected direct to pin 20, the input capacitance of the probe causes parasitic oscillation to stop, which makes it impossible to observe.

Sample Application Circuit 1

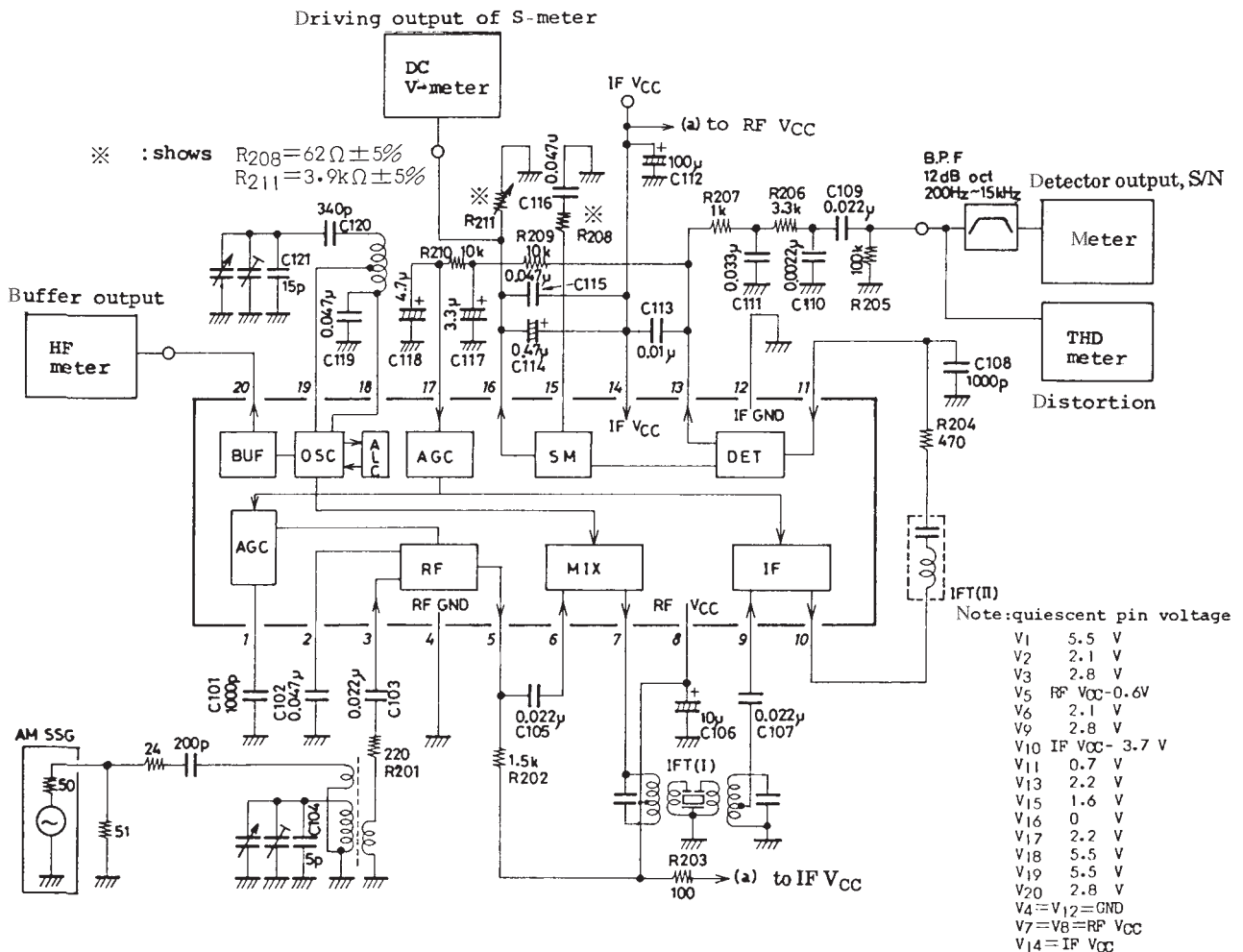

Unit (resistance : Ω, capacitance : F)

LA1245

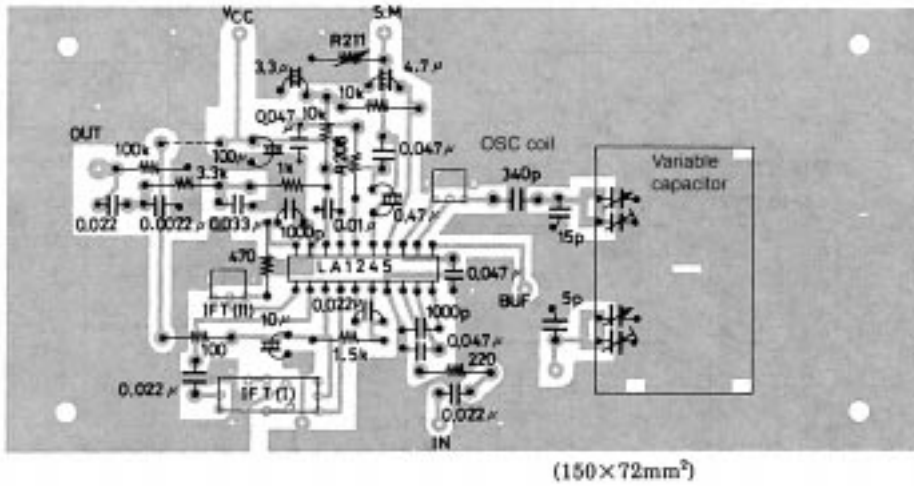

An Example of Printed Pattern (150x72mm², bottom view)

Unit (resistance: Ω, capacitance: F)

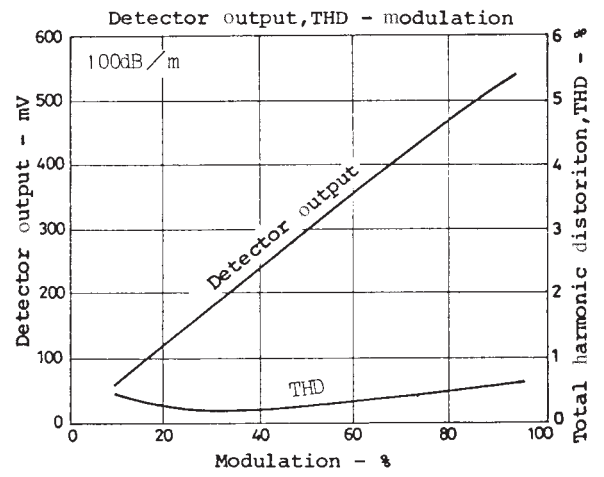
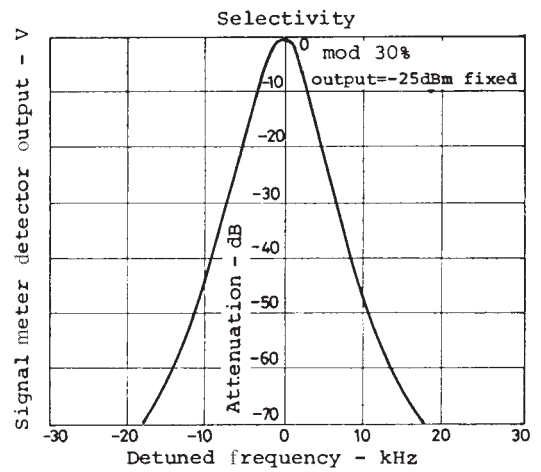
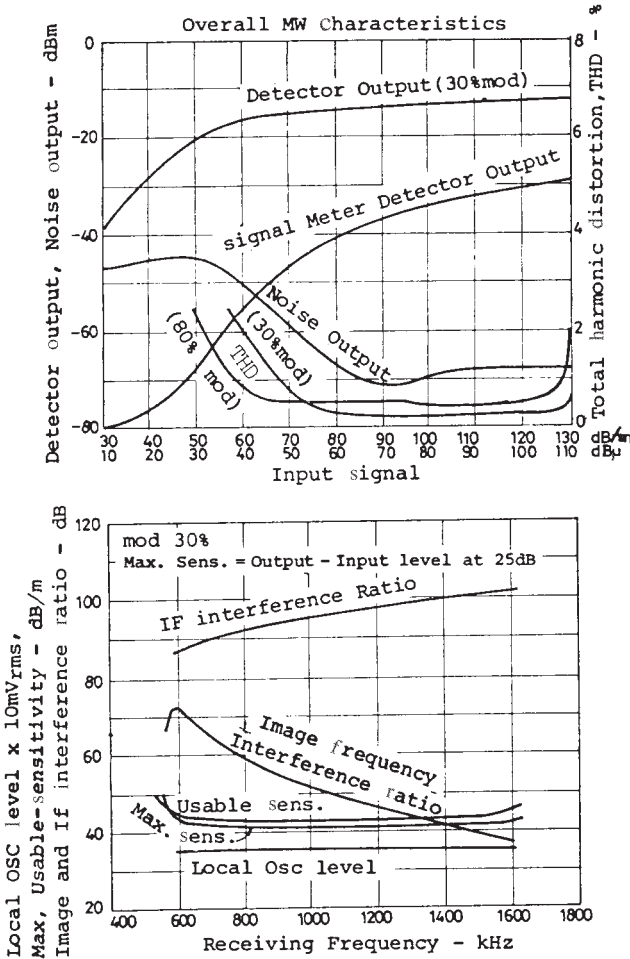

Detuned characteristic of signal meter

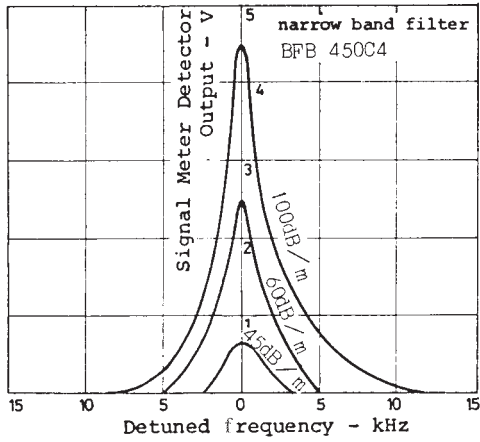

I_{CC} - Input

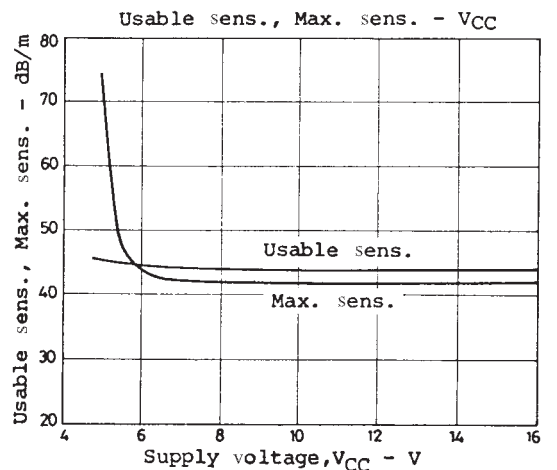
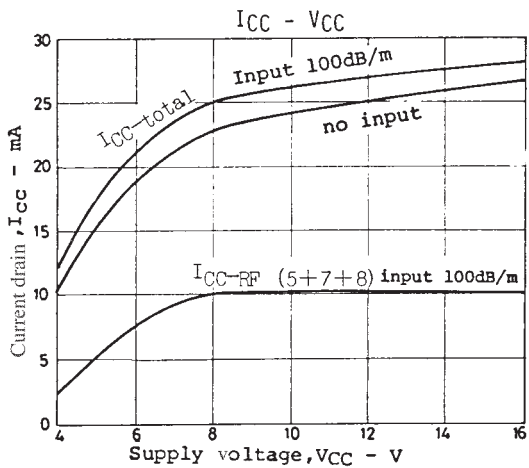
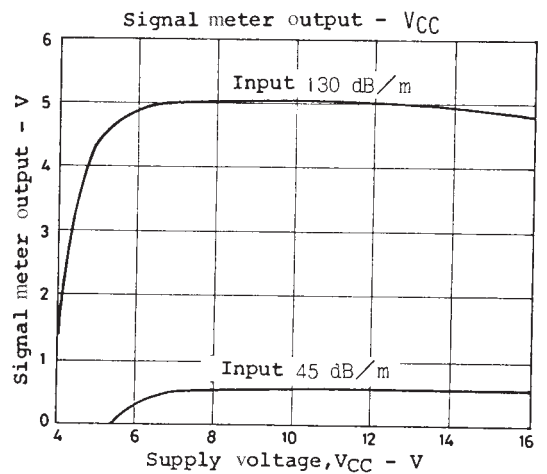
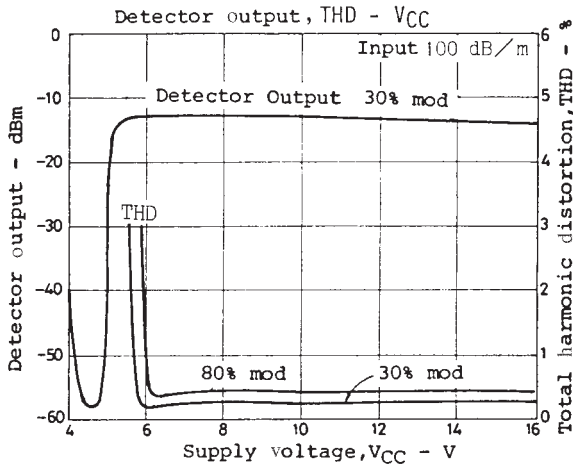
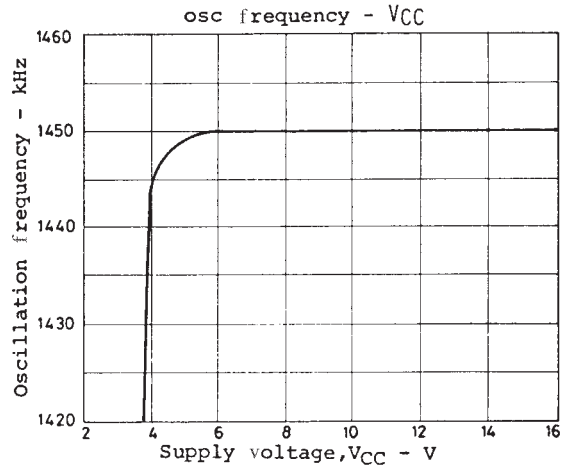
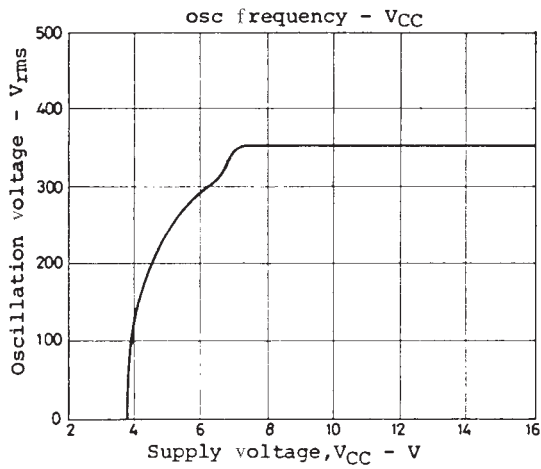
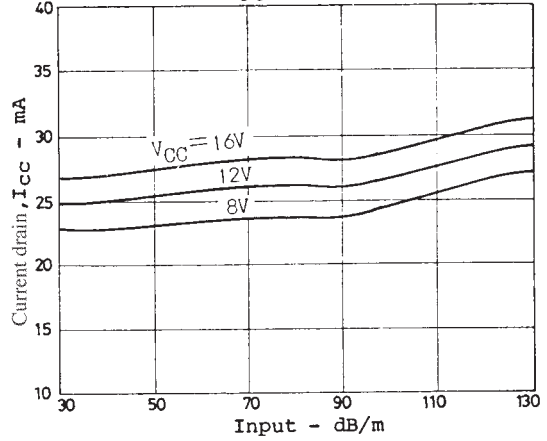

LA1245

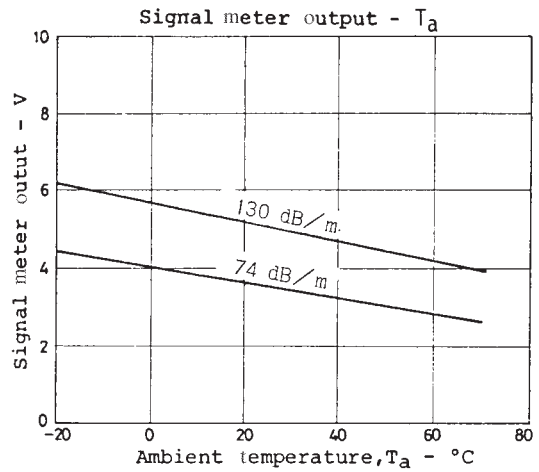
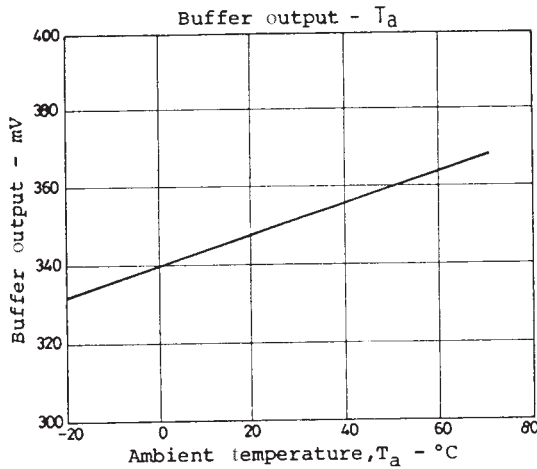
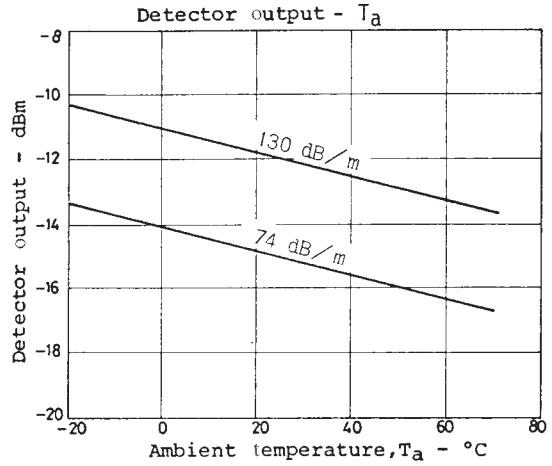
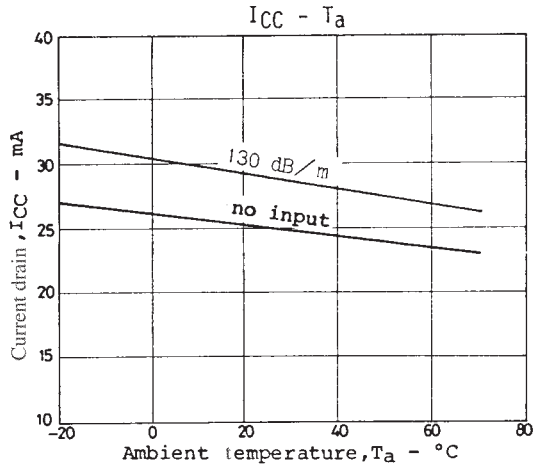

Sample Application Circuit 2 : Using variable capacitance diodes

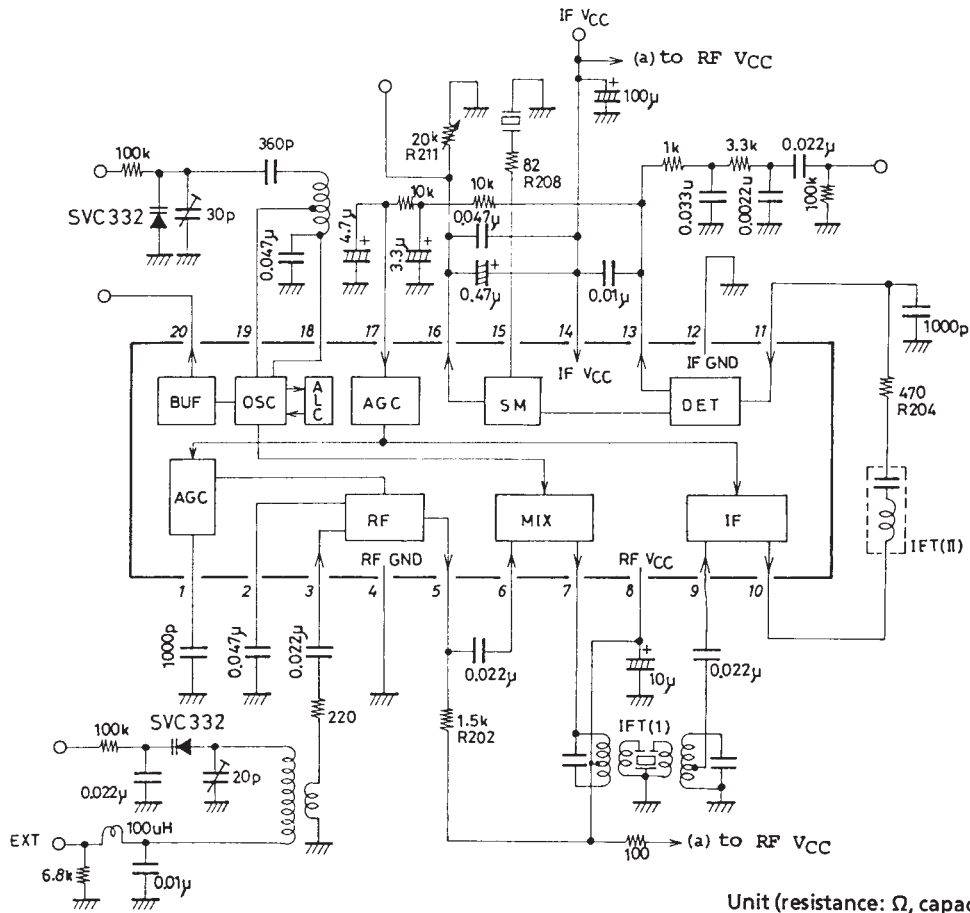

Unit (resistance: Ω, capacitance: F)

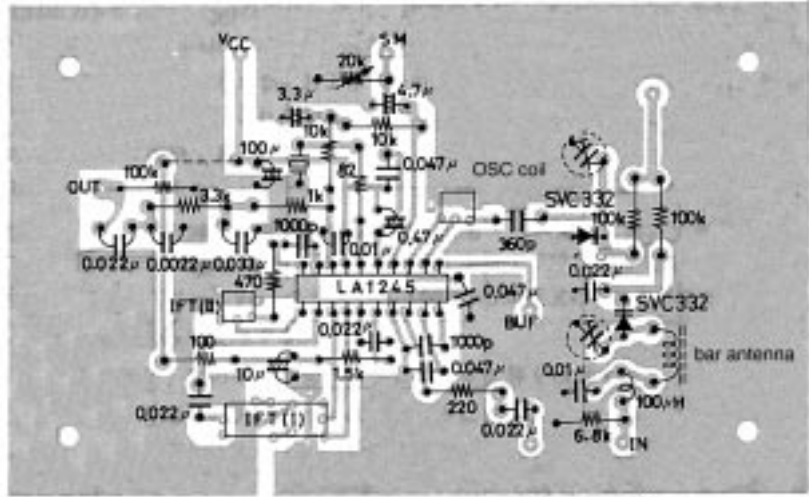

An Example of Printed Pattern (130x80mm², bottom view)

Unit (resistance: Ω, capacitance: F)

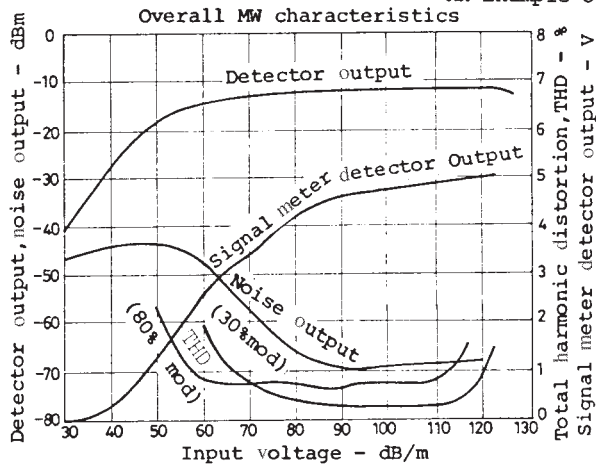

Sample Application Circuit 3 : Rejecting IFT (II)

Following 2 changes are recommended as C-coupling without IFT (II)

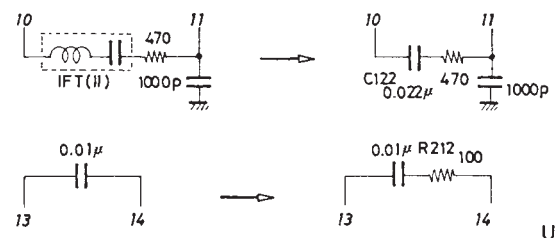

Unit (resistance: Ω, capacitance: F)

Comparison of characteristics varying parts.

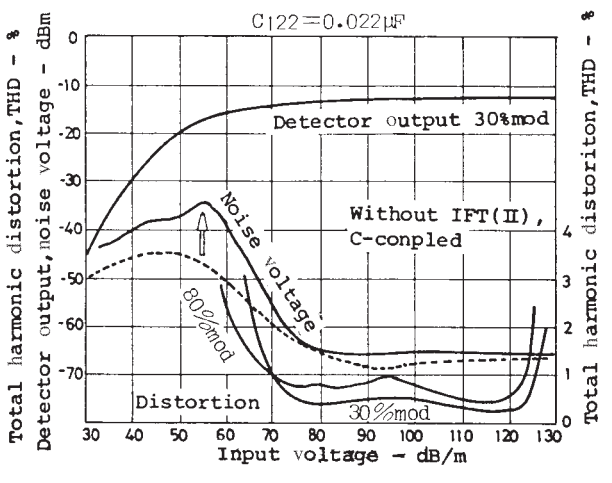
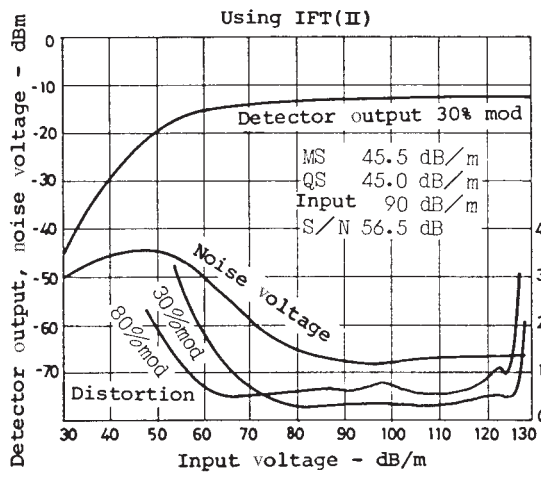

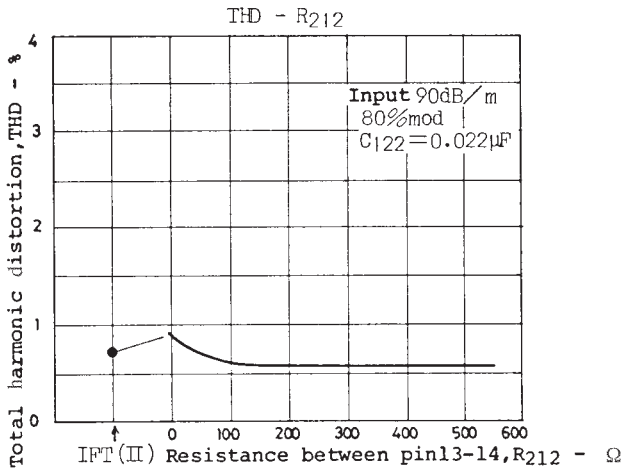
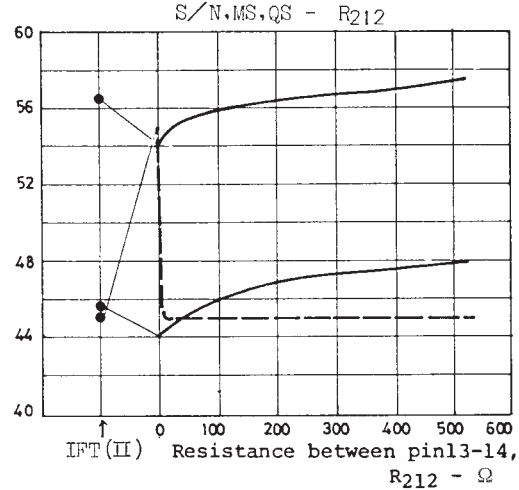
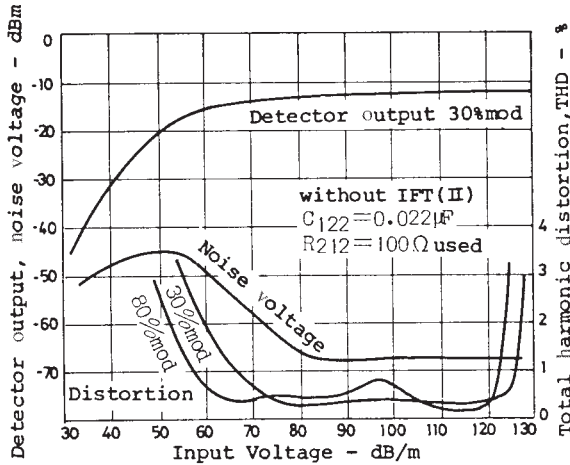

Peripheral Parts

(1) Bar Antenna (34H-052-869 Sumida Co.,)

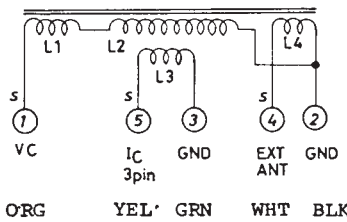

For use of general variable capacitor

L(between pins 1,2)=270µH
 $Q \geq 180$
 L1 : solenoid 43 t.
 L2 : space 42 t.
 L3 : solenoid 7 t.
 L4 : solenoid 4 t.

(2) Bar Antenna (C-4698 Coil Snake Co.,)

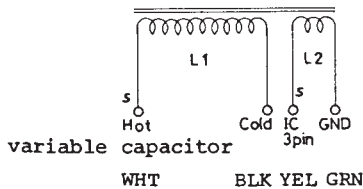

For use of variable capacitor diode

L(between pins 1,2)=250µH
 $Q \geq 250$
 L1 : solenoid 55 t.
 L2 : solenoid 5 t.

(3) Osc coil

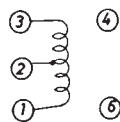

	2157-223-072 Sumida	2157-223-082 Sumida	7BR-6654Y Toko
	L(between pins 1 and 3)=147µH	L(between pins 1 and 3)=147µH	L(between pins 1 and 3)=147µH
	$Q \geq 85$	$Q \geq 85$	$Q \geq 90$
	③-② 39 t.	③-② 26t.	③-② 31 t.
	②-① 39 t.	②-① 52t.	②-① 31 t.

(4) Variable Capacitor (C123A Alps Co.,)

c max 326.8 pF
c min 6.7 pF

(5) Variable Capacitor Diode (SVC332 Sanyo)

(6) IFT (I) (CMFQ-021A Toko Co.,)

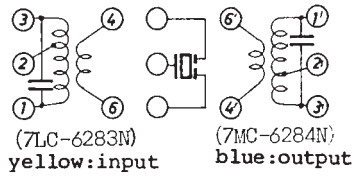

CMFQ-021A
 ③-② 58t. ③-② 18t.
 ②-① 98t. ②-① 130t.
 ⑥-④ 16t. ⑥-④ 16t.
Cent. Freq. 450kHz **Cent. Freq. 450kHz**
 $Q_u = 70 + 20\%$ $Q_u = 110$
Tuned Cap. 180pF **Tuned Cap. 180pF**

(7) IFT (II)

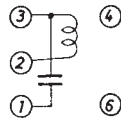

2150-208-033 Sumida Co.,	7LC-4751B Toko Co.,
Cent. Freq. 455kHz	Cent Freq. 455kHz
$Q \geq 95$	$Q \geq 75$
between 2 and 3 170t.	between 2 and 3 146t.
Tuned Cap. 180pF	Tuned Cap. 180pF

(8) Narrow Band Resonator (BFB450C4 N Murata Co.,)

■ No products described or contained herein are intended for use in surgical implants, life-support systems, aerospace equipment, nuclear power control systems, vehicles, disaster/crime-prevention equipment and the like, the failure of which may directly or indirectly cause injury, death or property lose.

■ Anyone purchasing any products described or contained herein for an above-mentioned use shall:

- ① Accept full responsibility and indemnify and defend SANYO ELECTRIC CO., LTD., its affiliates, subsidiaries and distributors and all their officers and employees, jointly and severally, against any and all claims and litigation and all damages, cost and expenses associated with such use:
- ② Not impose any responsibility for any fault or negligence which may be cited in any such claim or litigation on SANYO ELECTRIC CO., LTD., its affiliates, subsidiaries and distributors or any of their officers and employees jointly or severally.

■ Information (including circuit diagrams and circuit parameters) herein is for example only; it is not guaranteed for volume production. SANYO believes information herein is accurate and reliable, but no guarantees are made or implied regarding its use or any infringements of intellectual property rights or other rights of third parties.

This catalog provides information as of June, 1997. Specifications and information herein are subject to change without notice.