



# LA1193M, 1193V

## High-Performance FM Front End for Car Radios

### Overview

The LA1193M and LA1193V are front-end ICs developed for use in car radios. It incorporates an extremely wide dynamic range mixer and a new AGC system consisting of a dual-system wide-band AGC and a new keyed AGC to provide excellent interference suppression characteristics.

### Functions

- Double-balance mixer
- Pin diode drive output
- Differential IF amplifier
- Dual-system wide-band AGC circuit
- Local buffer output
- 3D-AGC system
- FET gate drive AGC output
- IF amplifier gain control pin

### Features

- Improved interference characteristics
  - Expanded mixer input dynamic range  
Mixer input usable sensitivity: 15 dB $\mu$   
Mixer input I.M. QS: 90 dB $\mu$   
(The dynamic range has been increased by 6 dB over the earlier LA1175M.)
  - Development of a new wide-band AGC circuit  
Improved interference characteristics for both near-channel interference and far-channel interference  
Improved interference characteristics for the TV band
  - Development of a 3D-AGC system  
The adjacent channel two-signal interference characteristics can be effectively improved without degrading the strong-field three-signal interference characteristics during keyed AGC operation.
- Improved stability design
  - AGC circuit local oscillator isolation  
Measures were taken to prevent the deterioration of AMR, noise level, THD and other characteristics during AGC operation.
  - AGC circuit incorrect operation measures  
The LA1193M provides methods to prevent incorrect operation due to local oscillator injection and loss of DC balance.

- Improved temperature characteristics
  - Conversion gain
  - AGC sensitivity
  - Antenna damping drive output current

### Package Dimensions

unit: mm

#### 3036B-MFP20

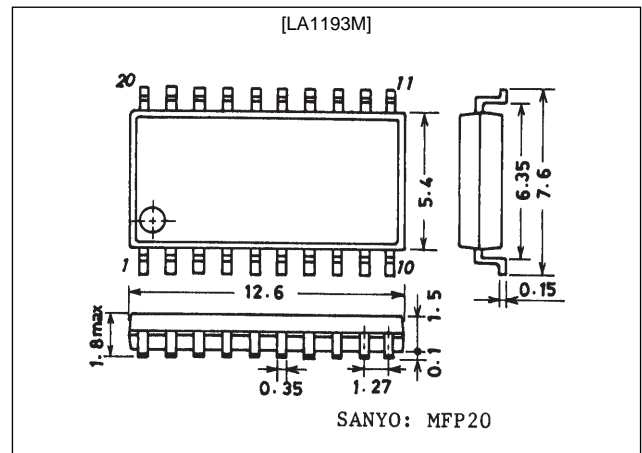

unit: mm

#### 3179A-SSOP20

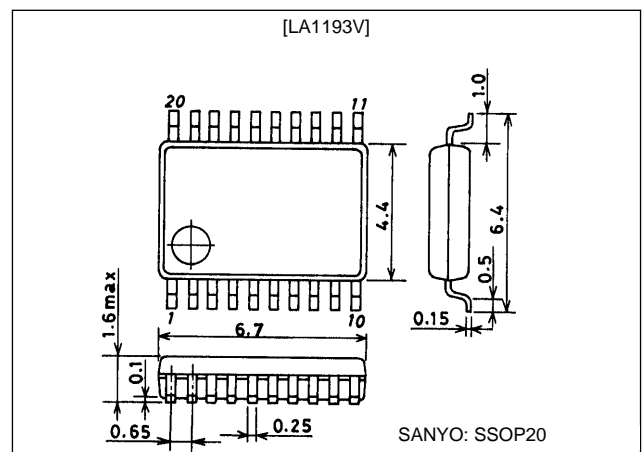

## LA1193M, 1193V

### Specifications

#### Maximum Ratings at $T_a = 25^\circ\text{C}$

Parameter	Symbol	Conditions	Ratings	Unit
Maximum supply voltage	$V_{CC}$ max	$V_{CC}$ for pins 5 and 17	9	V
	$V_{CC}$ max mix	$V_{CC}$ for pins 10 and 11	15	V
Allowable power dissipation	$P_d$ max	LA1193M: ( $T_a \leq 70^\circ\text{C}$ ) Mounted on a $41 \times 30 \times 1.1$ mm <sup>3</sup> glass-Epoxy board	500	mW
	$P_d$ max	LA1193V: ( $T_a \leq 70^\circ\text{C}$ ) Mounted on a $23 \times 36 \times 1.6$ mm <sup>3</sup> glass-Epoxy board	500	mW
Operating temperature	$T_{opr}$	*	-40 to +85	$^\circ\text{C}$
Storage temperature	$T_{stg}$		-40 to +125	$^\circ\text{C}$

Note: \* Connect a resistor (up to 10 k $\Omega$ ) between pins 17 and 19.

#### Operating Conditions at $T_a = 25^\circ\text{C}$

Parameter	Symbol	Conditions	Ratings	Unit
Recommended supply voltage	$V_{CC}$		8.0	V
Operating supply voltage range	$V_{CC}$ op		7.6 to 9	V

#### Operating Characteristics at $T_a = 25^\circ\text{C}$ , $V_{CC} = 8.0$ V, in the specified test circuit, $f = 88$ MHz, $f_{OSC} = 77.3$ MHz

Parameter	Symbol	Conditions	Ratings			Unit
			min	typ	max	
Current drain	$I_{CCO}$	No input, $V_{CONT} = 0$ V	19	24	29	mA
Antenna damping current	ANT-DI	88 MHz, 100 dB $\mu$ , $V_{CONT} = 4.0$ V	7.0	9.5	12.5	mA
AGC high voltage	$V_{AGC-H}$	88 MHz, 0 dB $\mu$ , $V_{CONT} = 4.0$ V	7.6	7.9		V
AGC low voltage	$V_{AGC-L}$	88 MHz, 100 dB $\mu$ , $V_{CONT} = 4.0$ V		0.4	0.9	V
Saturation output voltage	$V_{OUT}$	88 MHz, 110 dB $\mu$ , $V_{CONT} = 4.0$ V	97	110		dB $\mu$
-3 dB limiting sensitivity	$V_i$ -Limit	88 MHz, 110 dB $\mu$ , $V_{CONT} = 4.0$ V	78	85	92	dB $\mu$
Conversion gain	A. V	88 MHz, 75 dB $\mu$ , $V_{CONT} = 4.0$ V	98	101	104	dB $\mu$
Local buffer output	$V_{OSC}$ -Buff	No input, no modulation	105	109		dB $\mu$
Narrow $V_{AGC-ON}$	V-NAGC	88 MHz, $V_{CONT} = 4.0$ V, at an input level such that $V_{AGC-OUT}$ is 2 V or less	73 (76)	80 (83)	87 (90)	dB $\mu$
Wide $V_{AGC-ON}$	V-WAGC	88 MHz, $V_{CONT} = 0$ V, at an input level such that $V_{AGC-OUT}$ is 2 V or less	97	101	105	dB $\mu$
3D-AGC-ON	V3D-AGC	88 MHz, $V_{CONT}$ variable, with 95 dB $\mu$ being the $V_{CONT}$ voltage input such that $V_{AGC-OUT}$ switches from high to low and 2.0 V as the $V_{AGC}$ threshold value.	0.4	0.6	0.8	V

Note: Values in parenthesis are for LA1193V.





LA1193M, 1193V

Continued from preceding page.

US band antenna coil SA-140 or SA-231

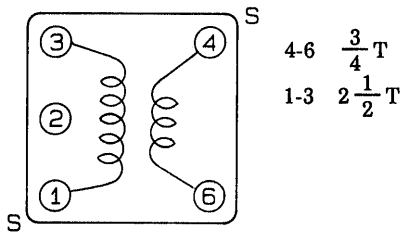

A00948

US band oscillator coil SA-278

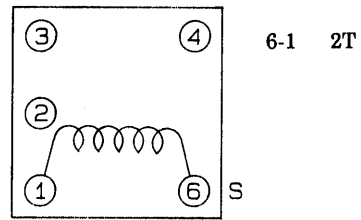

A00949

Mixer coil (for both bands) SA-266

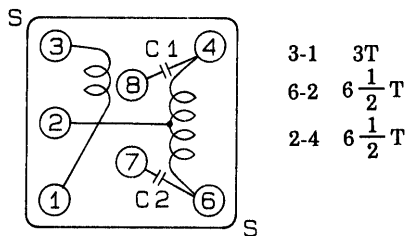

A00950

Pin Functions

Pin No.	Function	Equivalent circuit	Note
1	OSC BUFF	<p>A00951</p>	
2	OSC Tr. base	<p>A00952</p>	Colpitts oscillator

Continued on next page.

LA1193M, 1193V

Continued from preceding page.

Pin No.	Function	Equivalent circuit	Note
<p>6 7 10 11</p>	<p>Mix input (1) Mix input (2) Mix out (1) Mix out (2)</p>	<p>A00953</p>	<p>Mixer input usable sensitivity 15 dB<math>\mu</math> Mixer input I.M. QS 90.5 dB<math>\mu</math> (6.5 dB higher than previous products) Conversion gain 15 dB Input impedance 25 <math>\Omega</math></p>
<p>9</p>	<p>Antenna damping drive output</p>	<p>A00954</p>	<p><math>I_{ANTD} = 10 \text{ mA}</math></p>
<p>12</p>	<p>IF GND</p>		
<p>8</p>	<p>W-AGC input</p>	<p>A00955</p>	<p>Since the DC cut capacitor is provided on-chip in the pin internal circuit, we have taken steps to prevent incorrect AGC operation due to inter-pin leakage currents.</p>

Continued on next page.

LA1193M, 1193V

Continued from preceding page.

Pin No.	Function	Equivalent circuit	Note
13	N-AGC input	<p>A00956</p>	<p>Since the DC cut capacitor is provided on-chip in the pin internal circuit, we have taken steps to prevent incorrect AGC operation due to inter-pin leakage currents.</p>
14	IF AMP gain adjust	<p>A01985</p>	<p>IF gain: 25 dB                      Input and output impedances of 330 Ω                      The IF gain can be adjusted by inserting a resistor between pins 17 and 19.                      The gain is at its maximum when there is no resistor inserted.</p>
16	RF AGC output	<p>A00958</p>	<p>MOSFET                      Second gate control</p>
17	IF, AGC, V <sub>CC</sub>		
20	Keyed AGC input	<p>A00959</p>	<p>Controls the narrow AGC.</p>

1. Oscillator Circuit

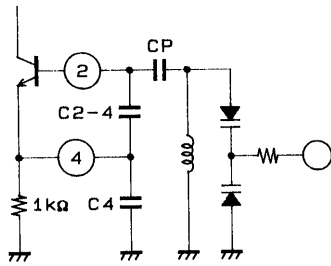

A00452

Steps were taken to prevent AMR degradation during earlier product type AGC operation, since the local oscillator block in this IC has independent Vd (pin 5) and ground (pin 3) connections.

This is a Colpitts oscillator and has the same structure as that used in earlier circuits. The oscillation level and intensity are changed by capacitors C<sub>2,4</sub>, C<sub>4</sub> and C<sub>p</sub>.

2. Local Oscillator Buffer Output

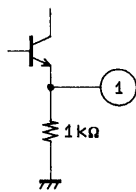

A00453

This buffer is an emitter follower circuit.

If desired, the buffer efficiency can be increased by inserting a resistor between pin 1 and ground to pass more current through the buffer transistor. However, this current must be limited so that P<sub>dmax</sub> for the package is not exceeded.

3. Interference Characteristics

The LA1193M incorporates a newly developed 3D-AGC (triple dimension) circuit. This circuit allows three-signal interference characteristics (inter-modulation characteristics) and two-signal sensitivity suppression characteristics to be provided at the same time, a combination of characteristics previously thought difficult to achieve.

• Inter-Modulation Characteristics

The LA1193M prevents inter-modulation distortion by applying two wide-band AGC circuits.

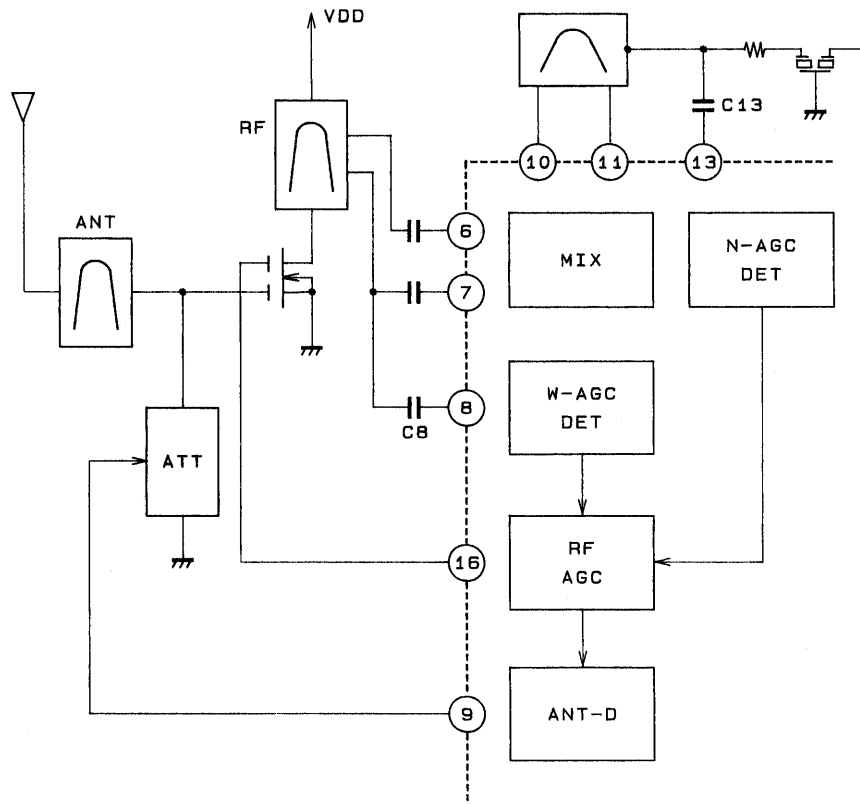

Figure 1

A00454



This double wide-band AGC system consists of two AGC circuits and a narrow AGC (pin 13 input, mixer input detection type) as shown in Figure 1. Figure 2 shows the antenna input frequency characteristics.

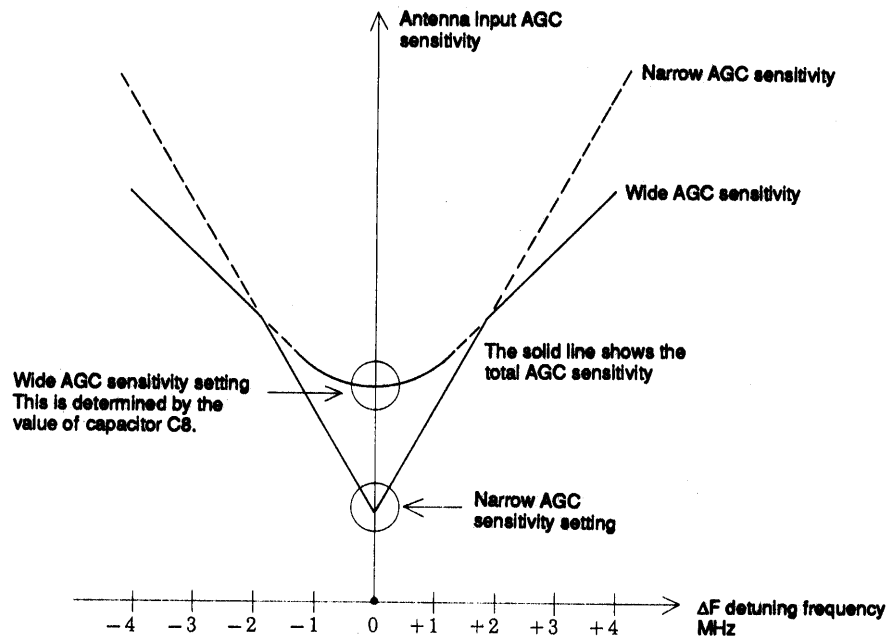

Figure 2 AGC Sensitivity Detuning Characteristics

Features of the Double Wide AGC System

- Since this is a mixer input detection wide-band AGC, it prevents the occurrence of intermodulation due to interfering stations with  $\Delta f > 1$  MHz. (TV band interference prevention)
- Since this system uses a narrow AGC at the same time, the wide AGC sensitivity can be lowered, thus preventing incorrect operation due to local oscillator injection.
- Optimal sensitivities for any field conditions can be set, since the sensitivities of both the wide and narrow AGC systems can be set by changing the values of external components.
- The input level of the desired station is limited by the narrow AGC. As a result, excessive levels are no longer input to the stages that follow the mixer and the beats at multiples of  $10.7 \times A$  are reduced.

• Two-Signal Sensitivity Suppression Characteristics

Previously, keyed AGC systems were used to provide good intermodulation distortion and two signal sensitivity suppression characteristics at the same time. However, in previous keyed AGC systems, when the desired station would fade or drop out, the wide band AGC level would become essentially zero. As a result, the automatic station selection function would malfunction and blocking oscillation would occur in the presence of strong interfering stations. Thus keyed AGC systems were extremely hard to use in actual practice. Sanyo has developed a new AGC system (3D-AGC) that solves these problems and allows the construction of extremely simple application circuits. The LA1193M/V incorporates this AGC system.

What is the 3D-AGC system?

It is a system that determines the wide-band AGC level by using information that has the following three frequency characteristics.

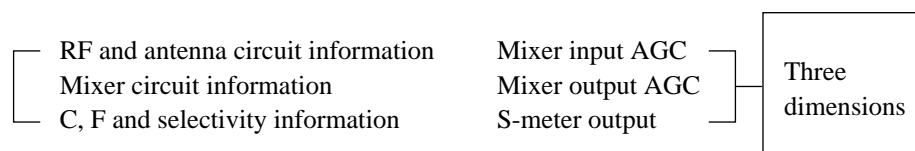

### 3D-AGC Features

Feature	Merit
The narrow AGC sensitivity, which operates for $\Delta f$ of less than 1.5 MHz, is controlled independently according to the field strength of the desired station.	<ul style="list-style-type: none"> <li>This is effective as a measure for mitigating two signal sensitivity suppression.</li> </ul>
The narrow AGC sensitivity is controlled at $V_{20}$ values under 2 V.	<ul style="list-style-type: none"> <li>This allows two signal sensitivity suppression to be mitigated without deterioration in the three signal characteristics.</li> </ul>
The wide AGC operates even when $V_{20}$ is zero, i.e., when the desired station does not exist.	<ul style="list-style-type: none"> <li>This allows the prevention of incorrect stopping on intermodulation signals during search.</li> <li>This allows the prevention of intermodulation occurring in the antenna and RF modulation circuits in the presence of strong interfering stations. Prevention of blocking oscillation due to AGC operation is also possible.</li> </ul>
The N-AGC and the W-AGC sensitivities can be set independently.	<ul style="list-style-type: none"> <li>This allows optimal settings to match the reception field conditions.</li> </ul>
The system has two AGC systems, the N-AGC and the W-AGC.	<ul style="list-style-type: none"> <li>Since the narrow AGC operates at the desired station and at adjacent stations, it is possible to reduce the wide AGC sensitivity. This prevents incorrect AGC operation due to local oscillator injection.</li> </ul>

### 3D-AGC Sensitivity, $\Delta f$ and $V_{20}$ Characteristics

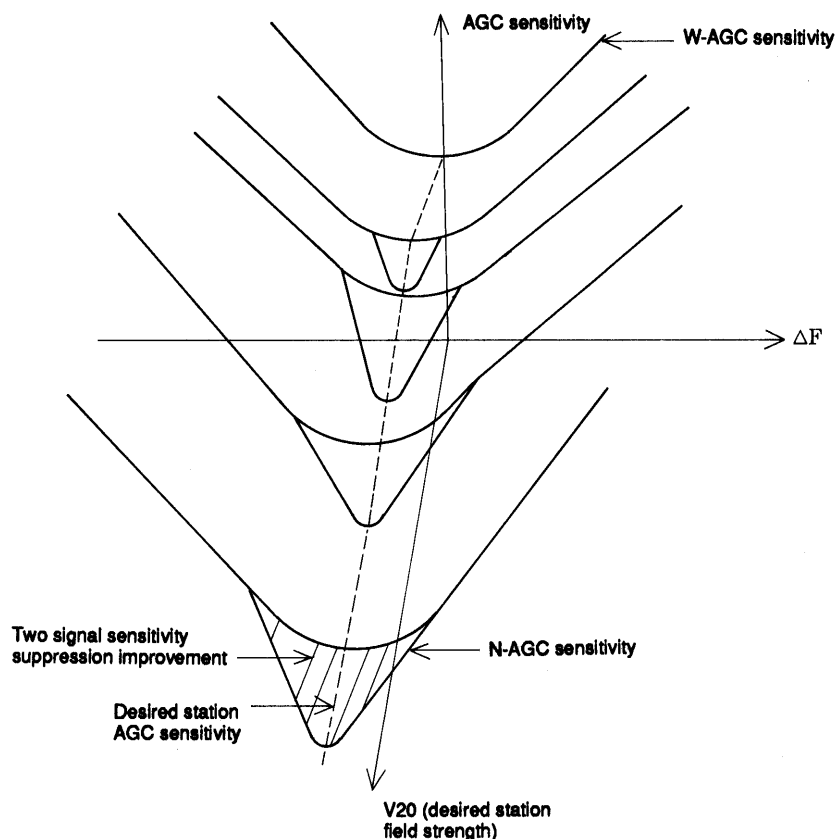

**Figure 3 3D-AGC Sensitivity,  $\Delta f$  and  $V_{20}$  Characteristics**

- The W-AGC sensitivity is determined by the antenna RF circuit selectivity independently of  $V_{20}$ .
- The N-AGC sensitivity is determined by the antenna, RF and mixer circuit total selectivity when  $V_{20}$  is 0.6 V or greater. It is determined by that selectivity and  $V_{20}$  when  $V_{20}$  is over 0.6 V.
- The improvement in two-signal sensitivity suppression is the shaded area in the total AGC sensitivity and corresponds to the section occupied by the N-AGC.

4. Mixer

The mixer circuit used in this IC is a balanced input/balanced output double balance mixer circuit.

• Input Format

Emitter input  
Input impedance: 25 Ω

Optimization of the component geometry, emitter current and bias allow this circuit to achieve the following performance.

Mixer input usable sensitivity: 15 dBμ  
Mixer input IMQS\*: 90.5 dBμ

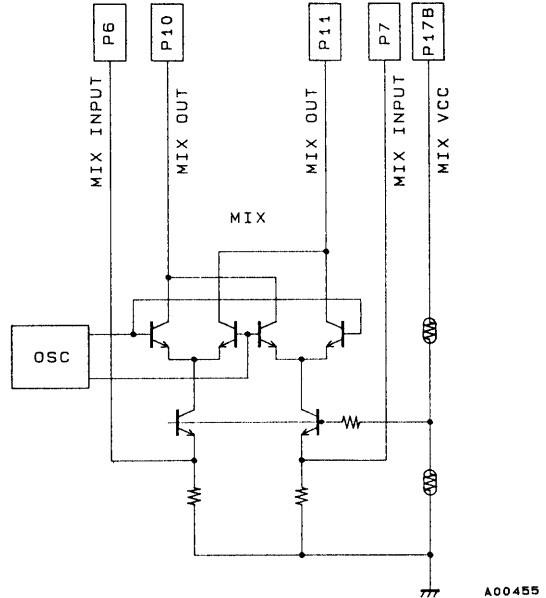

**Figure 4 Mixer Circuit**  
**(Improved by 6.0 dBμ over previous products.)**

Note: \* Mixer input IMQS is defined as follows:

- $f_r = 98.8 \text{ MHz}$ , no input
- $f_{u1} = 98.8 \text{ MHz}$ , 1 kHz, 30% modulation
- $f_{u2} = 99.6 \text{ MHz}$ , no modulation

IMQS is the interference 1 and 2 input levels such that when an interference signal with the same level is input to the mixer and distortion occurs at the mixer, the generated IM output has a S/N ratio of 30 dB.

5. IF Amplifier

This IF amplifier is a single stage differential amplifier.

Specifications

Input impedance: 330 Ω  
Output impedance: 330 Ω  
Gain: 25 dB

Gain adjustment can be provided using either of the methods shown.

IF Gain adj

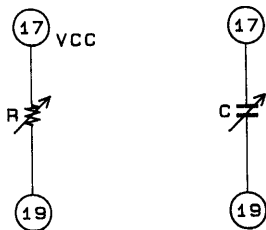

A01967

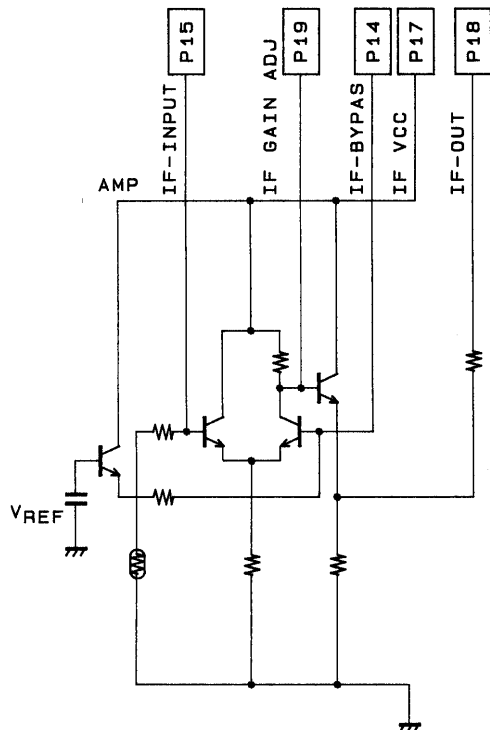

A01966

Temperature Characteristics

The LA1193M/V uses Vref temperature characteristics correction to hold the gain temperature characteristics to the low level of about 1 dB over the range -30 to +80°C.



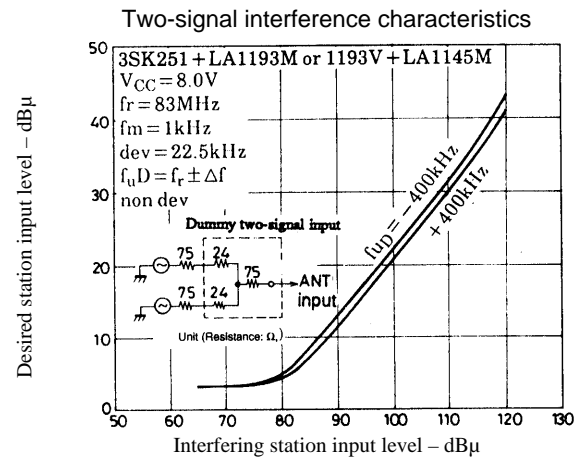
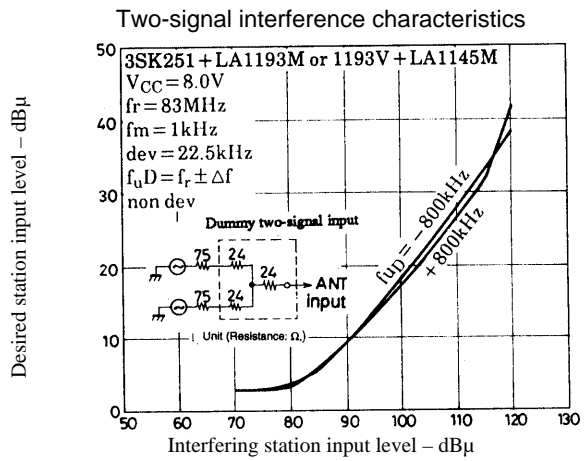
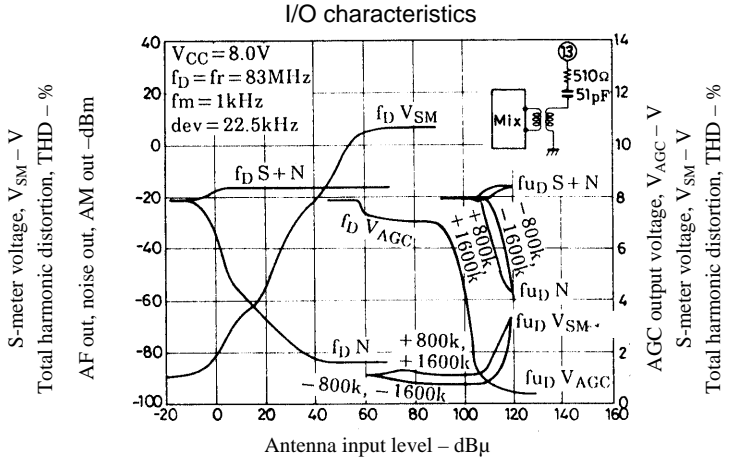
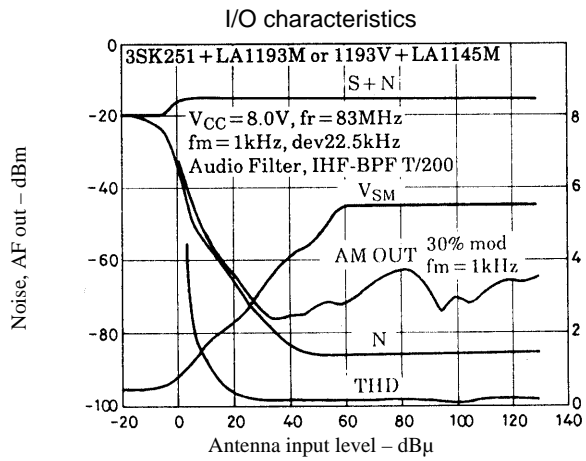
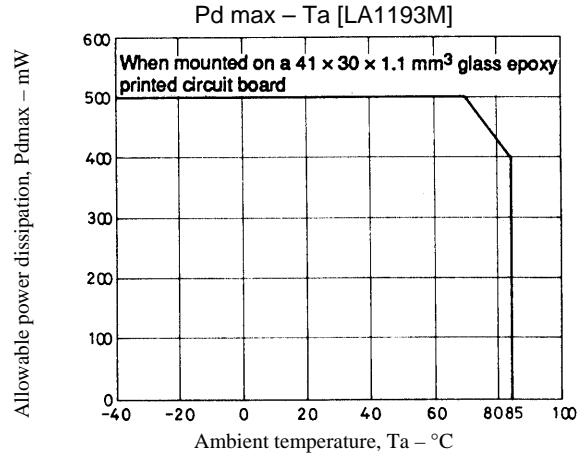
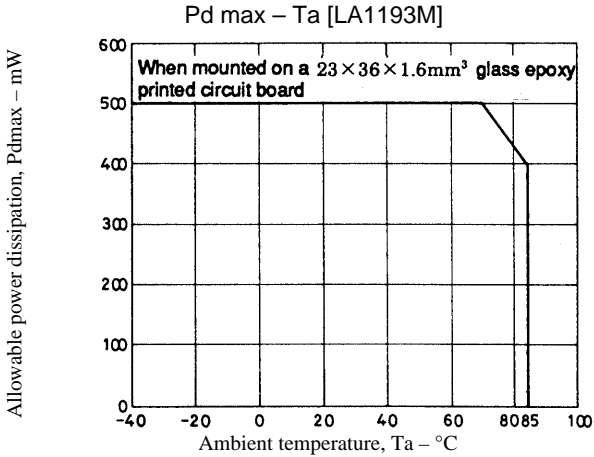

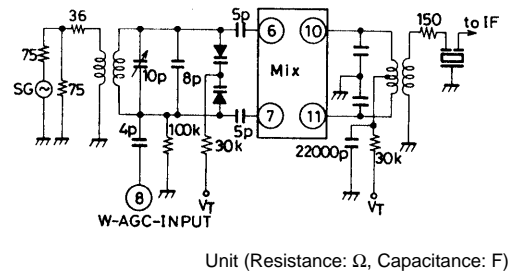
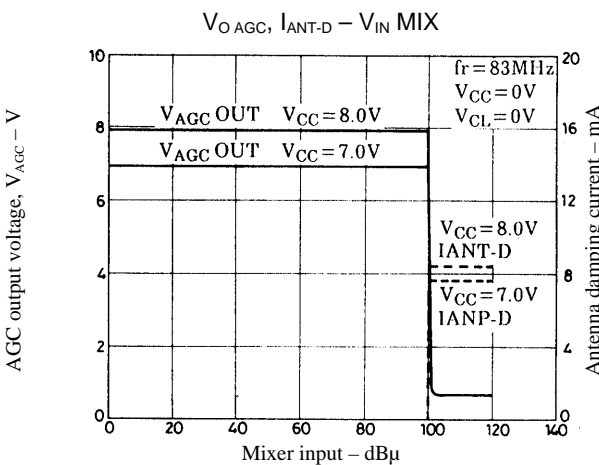
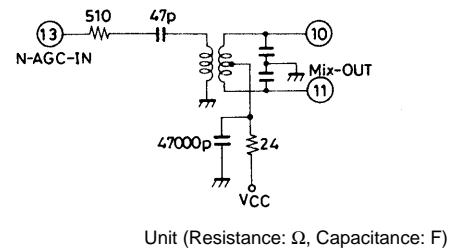
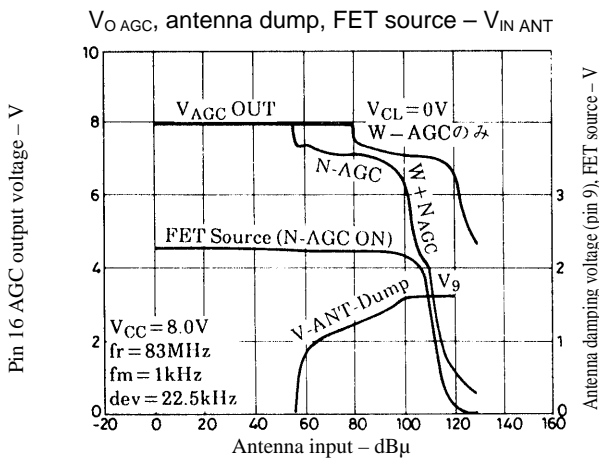
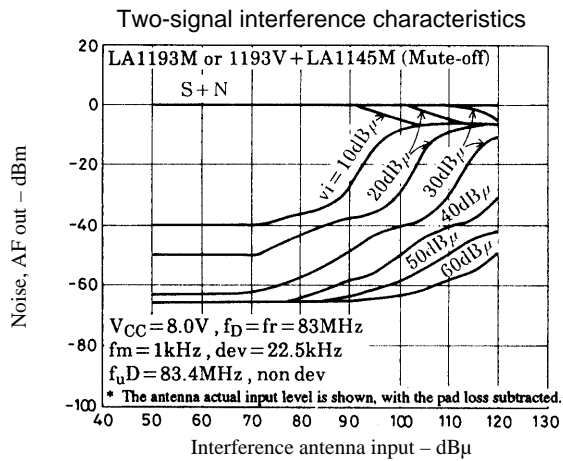
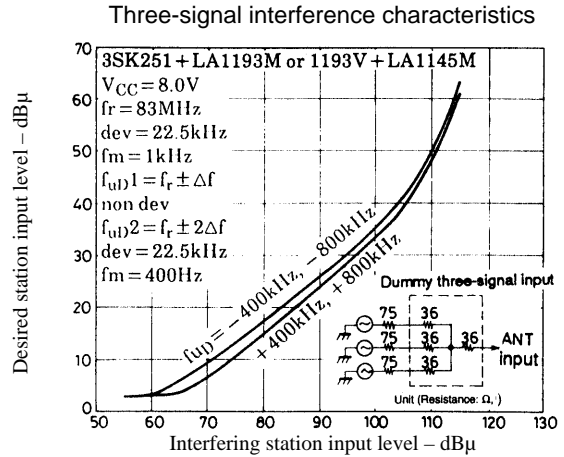
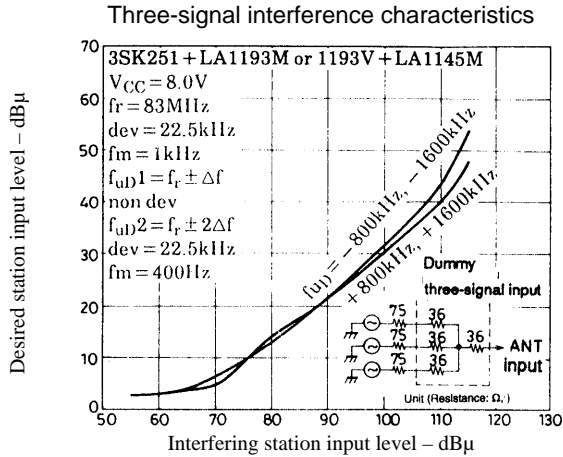

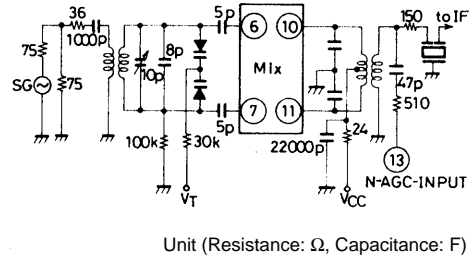
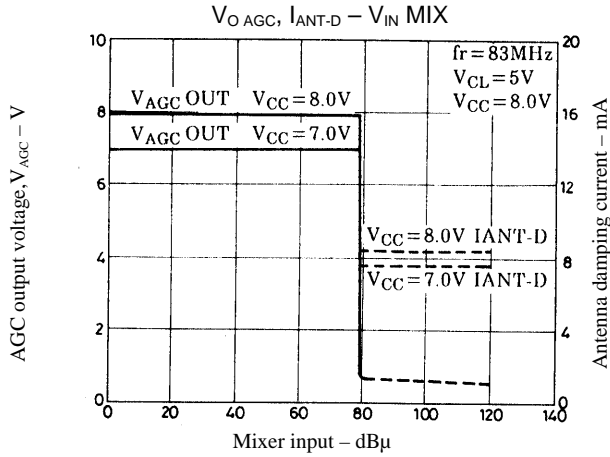

Unit (Resistance: Ω, Capacitance: F)

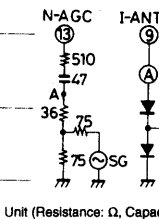
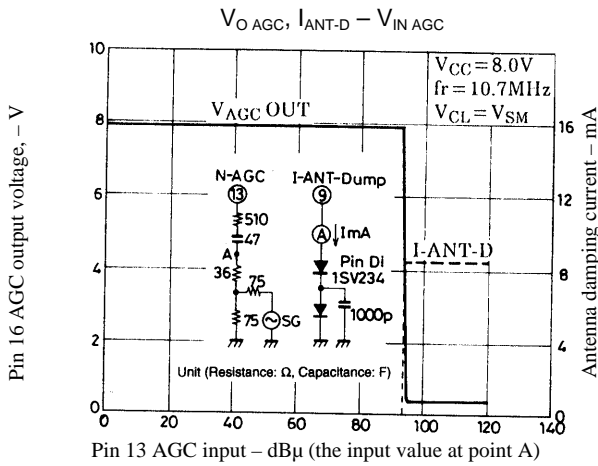

Unit (Resistance: Ω, Capacitance: F)

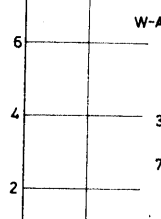
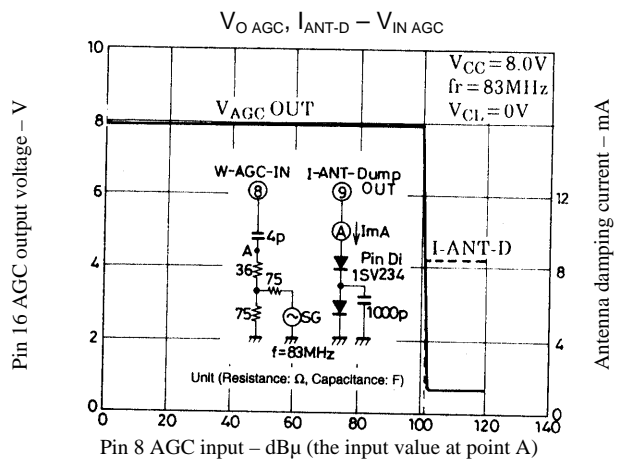

Unit (Resistance: Ω, Capacitance: F)

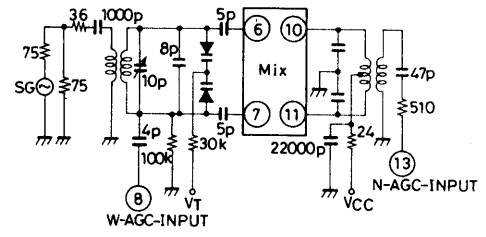
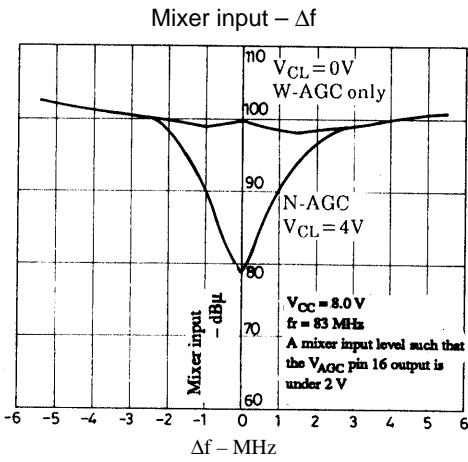

Unit (Resistance: Ω, Capacitance: F)

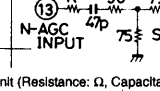
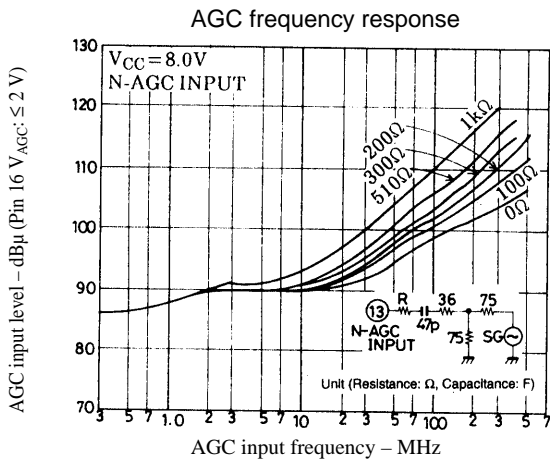

Unit (Resistance: Ω, Capacitance: F)

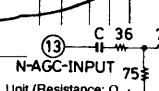
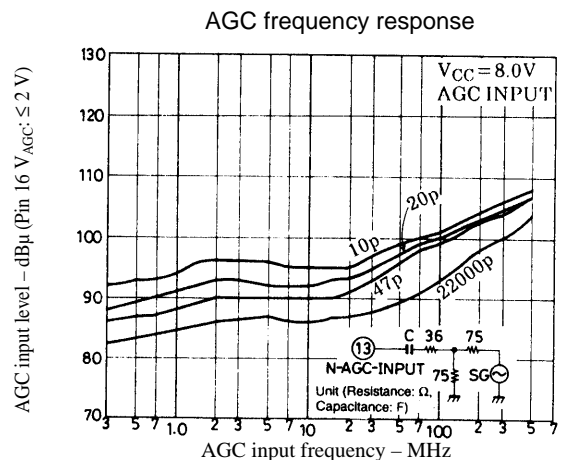

Unit (Resistance: Ω, Capacitance: F)

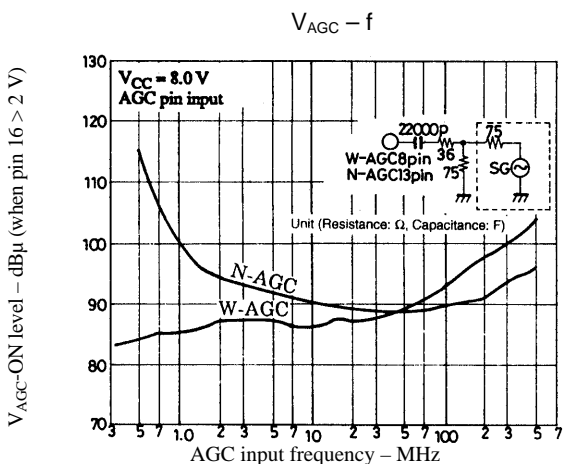
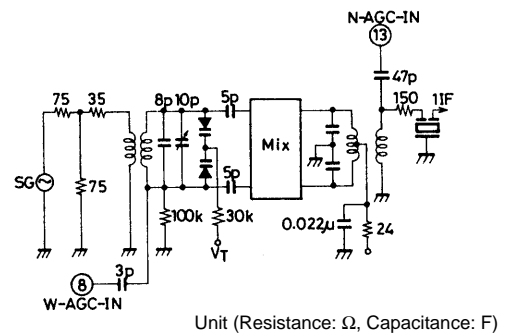
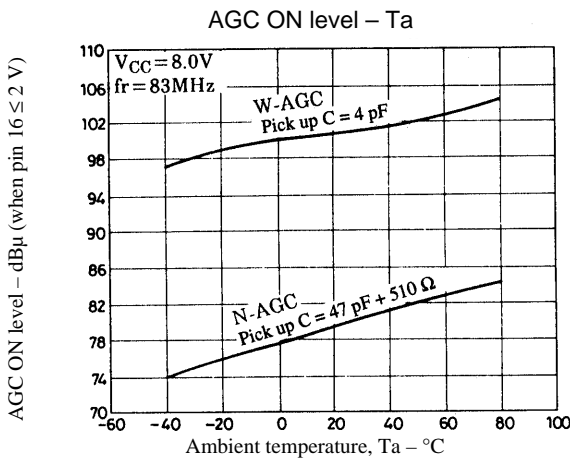
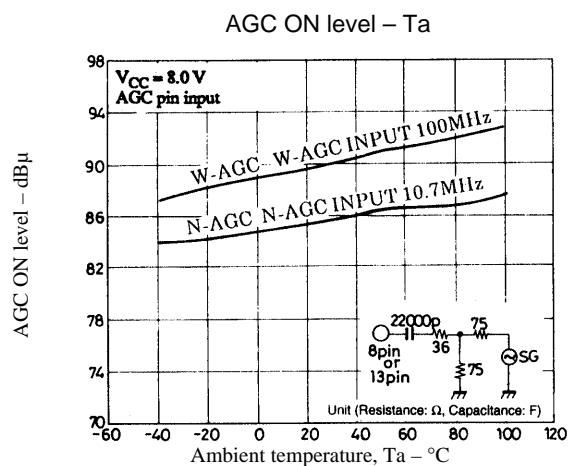
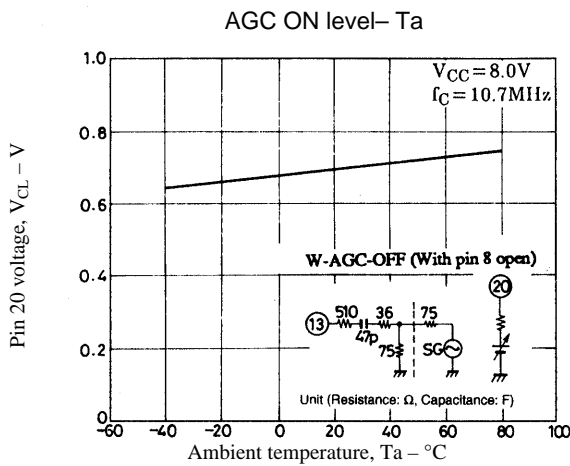
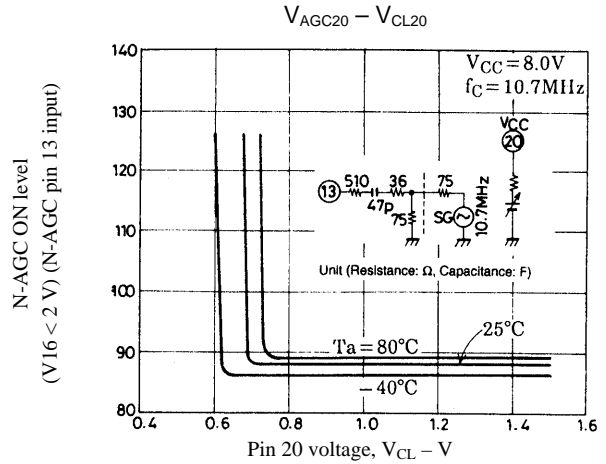
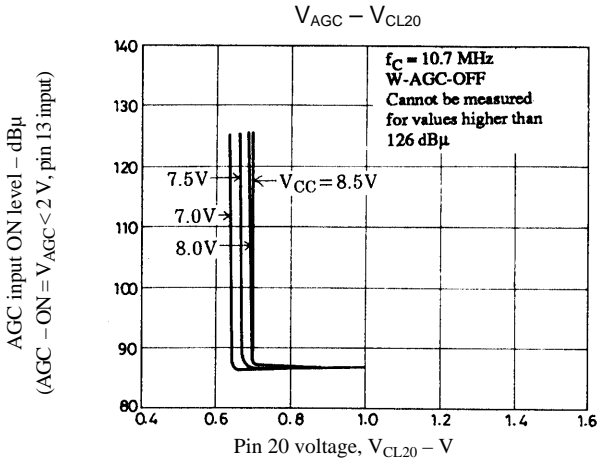



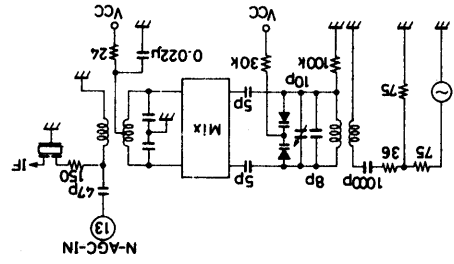
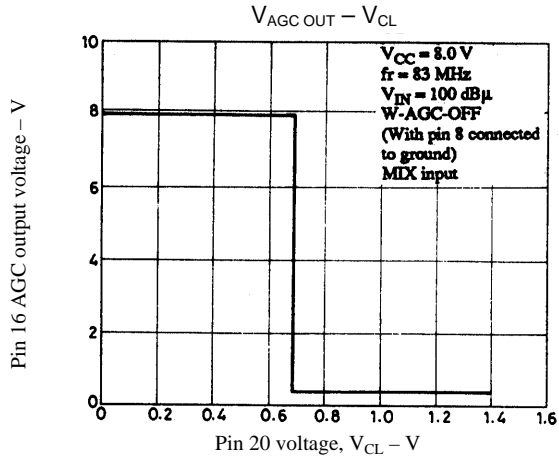

Unit (Resistance:  $\Omega$ , Capacitance: F)

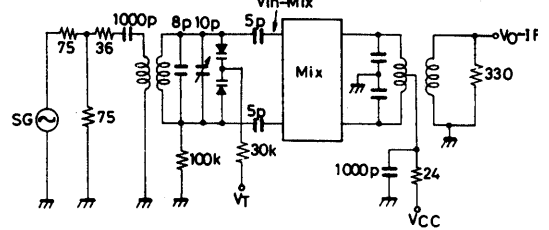
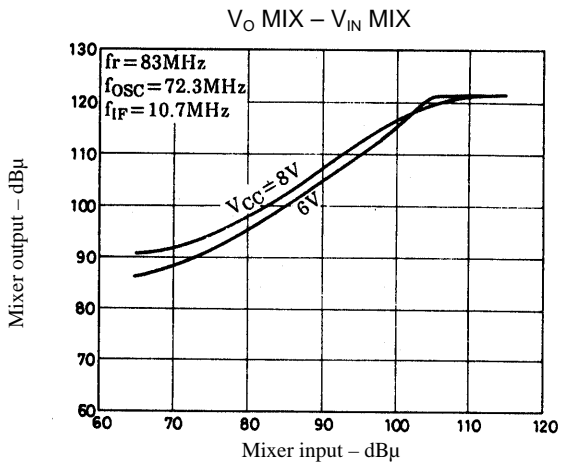
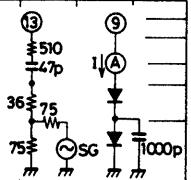
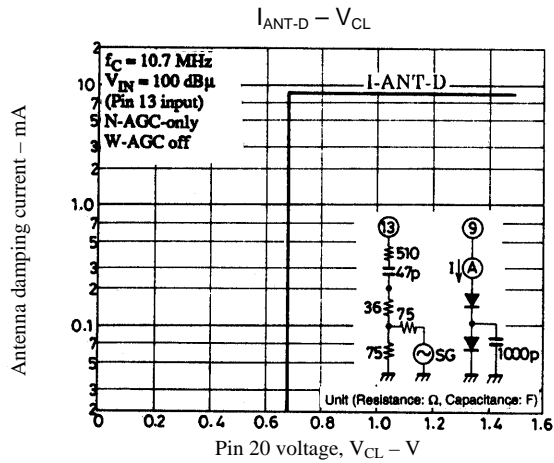

Unit (Resistance:  $\Omega$ , Capacitance: F)

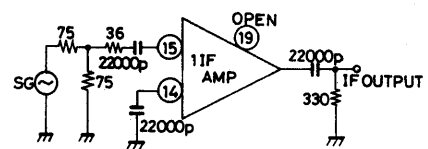
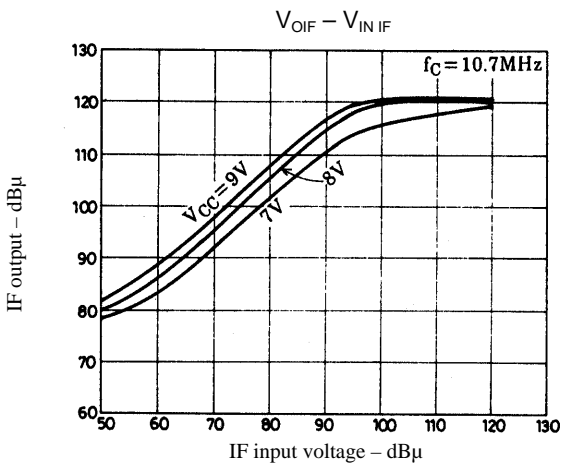

Unit (Resistance:  $\Omega$ , Capacitance: F)

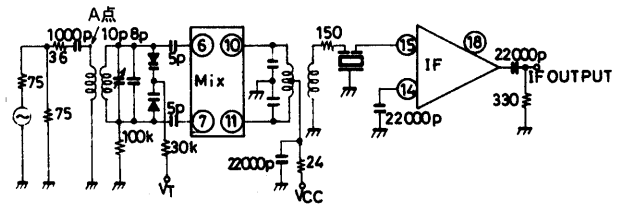
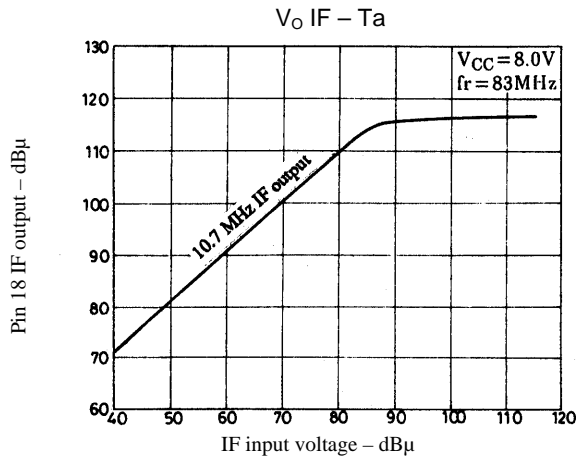

Unit (Resistance:  $\Omega$ , Capacitance: F)

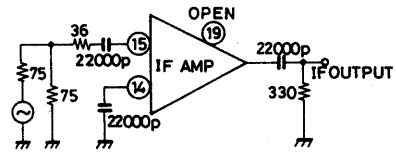
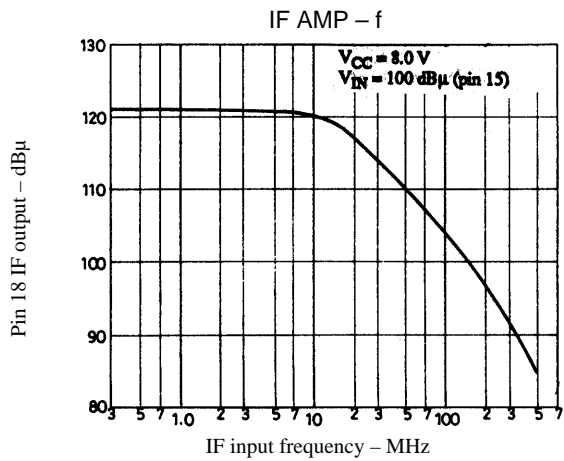

Unit (Resistance:  $\Omega$ , Capacitance: F)

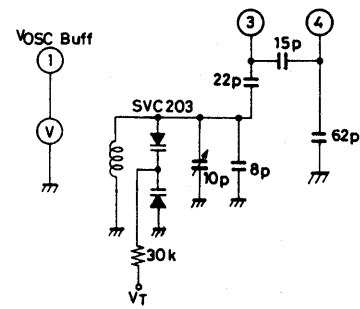
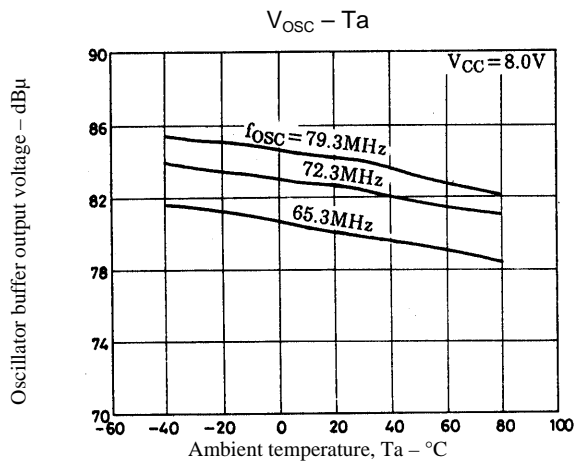

Unit (Resistance:  $\Omega$ , Capacitance: F)

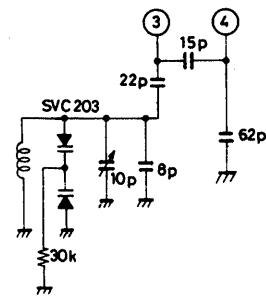
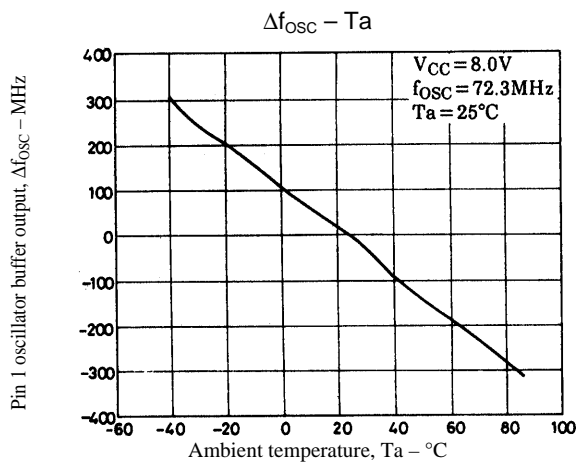

Unit (Resistance:  $\Omega$ , Capacitance: F)

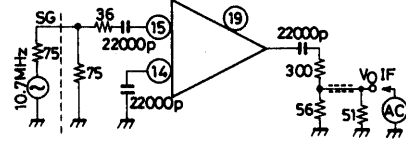
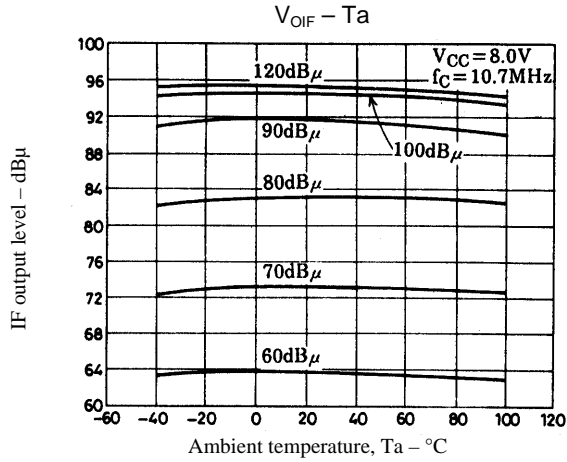

Unit (Resistance:  $\Omega$ , Capacitance: F)

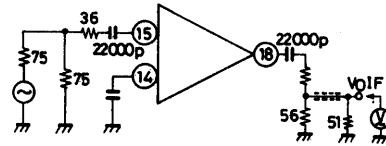
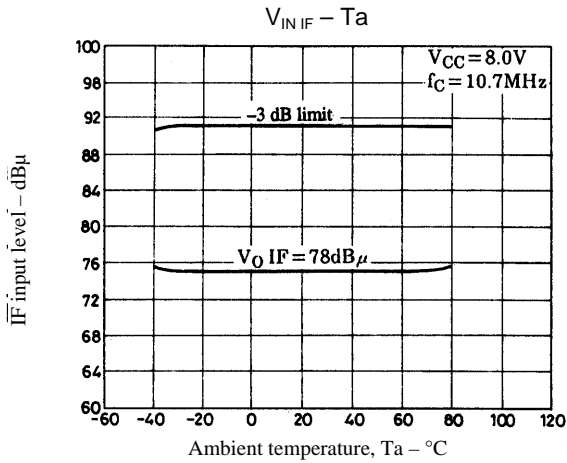

Unit (Resistance:  $\Omega$ , Capacitance: F)

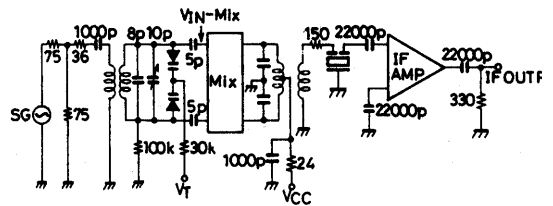
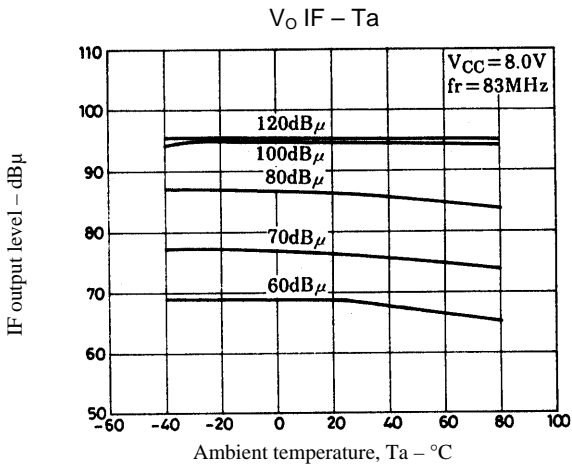

Unit (Resistance:  $\Omega$ , Capacitance: F)

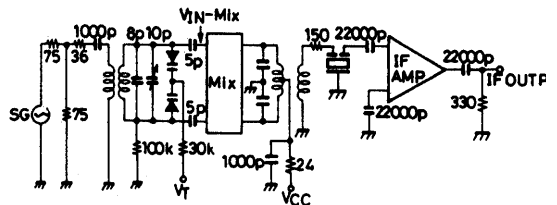
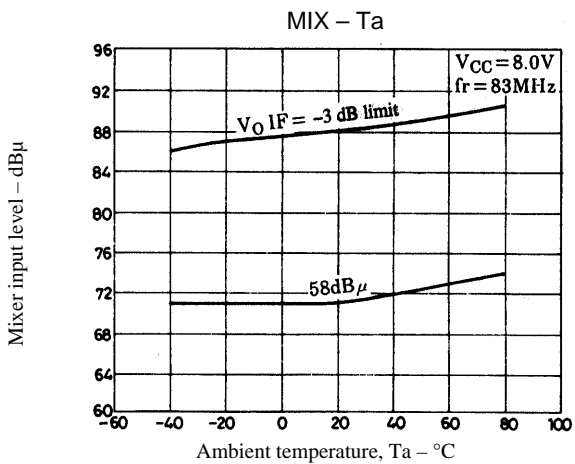

Unit (Resistance:  $\Omega$ , Capacitance: F)

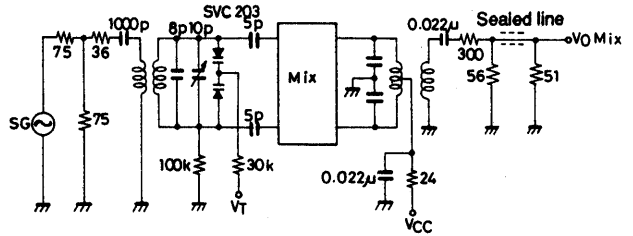
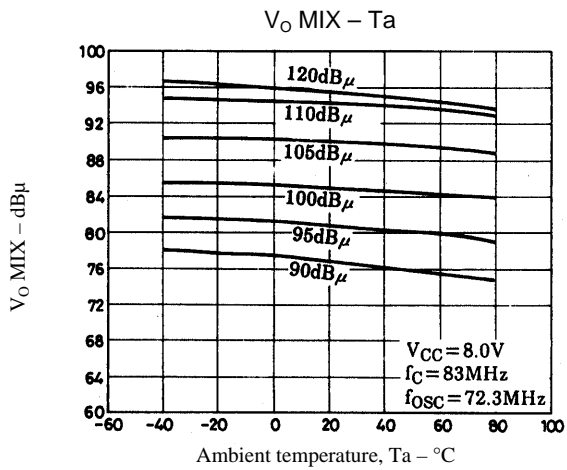
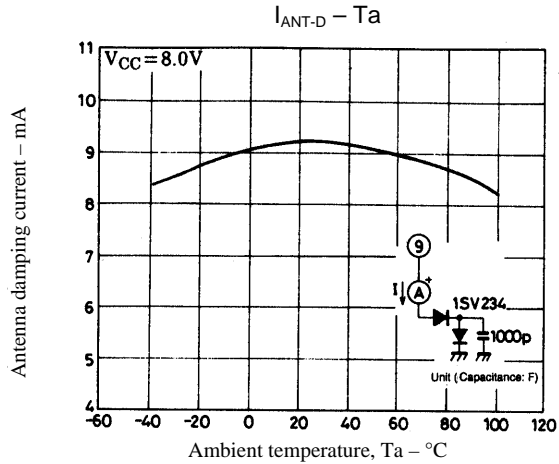

Unit (Resistance:  $\Omega$ , Capacitance: F)

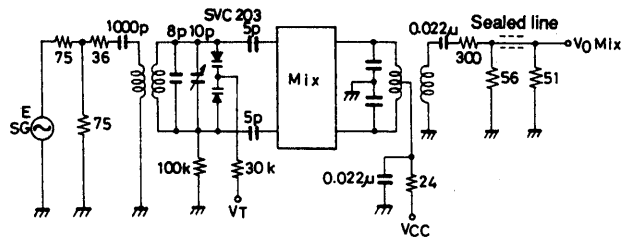
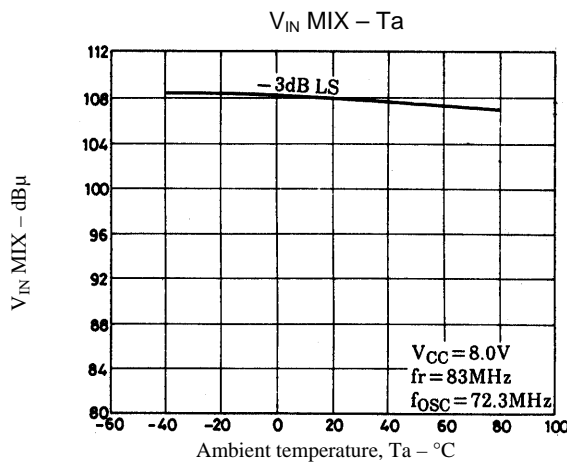

Unit (Resistance:  $\Omega$ , Capacitance: F)

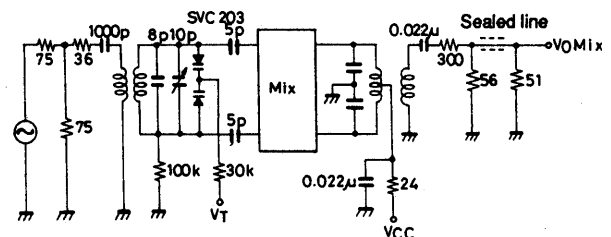
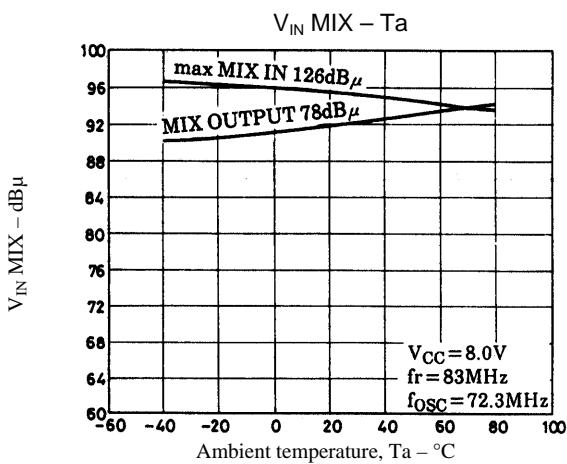

Unit (Resistance:  $\Omega$ , Capacitance: F)

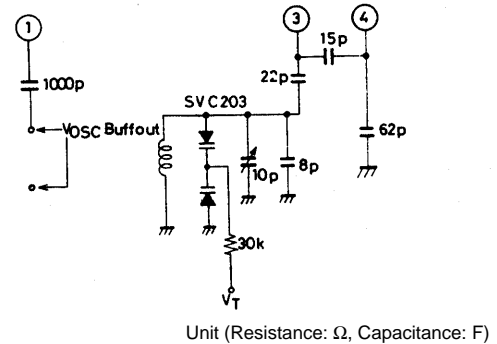
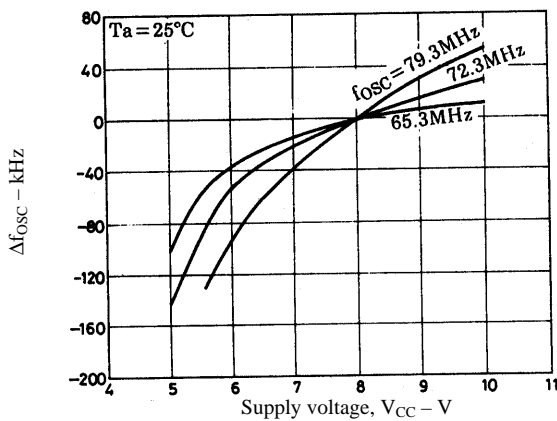
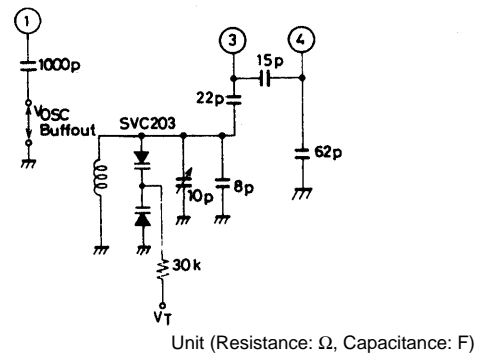
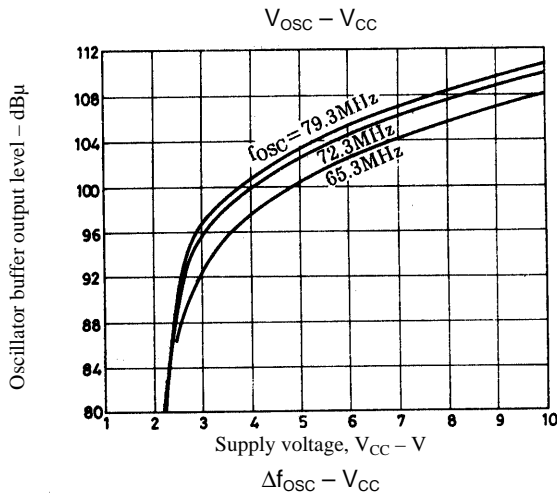
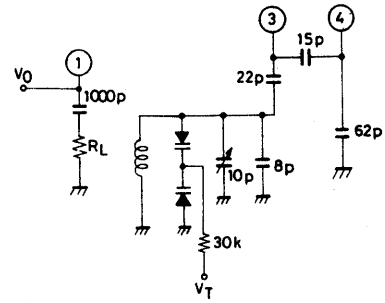
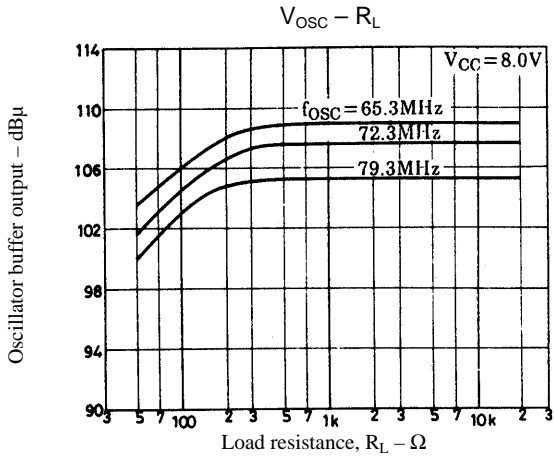

■ No products described or contained herein are intended for use in surgical implants, life-support systems, aerospace equipment, nuclear power control systems, vehicles, disaster/crime-prevention equipment and the like, the failure of which may directly or indirectly cause injury, death or property loss.

■ Anyone purchasing any products described or contained herein for an above-mentioned use shall:

- ① Accept full responsibility and indemnify and defend SANYO ELECTRIC CO., LTD., its affiliates, subsidiaries and distributors and all their officers and employees, jointly and severally, against any and all claims and litigation and all damages, cost and expenses associated with such use;
- ② Not impose any responsibility for any fault or negligence which may be cited in any such claim or litigation on SANYO ELECTRIC CO., LTD., its affiliates, subsidiaries and distributors or any of their officers and employees jointly or severally.

■ Information (including circuit diagrams and circuit parameters) herein is for example only; it is not guaranteed for volume production. SANYO believes information herein is accurate and reliable, but no guarantees are made or implied regarding its use or any infringements of intellectual property rights or other rights of third parties.

This catalog provides information as of March, 1997. Specifications and information herein are subject to change without notice.