



LA1175, 1175M

FM Front End For Car Radio, Home Stereo Applications

Functions

- Double-balanced type MIX, PIN diode drive AGC output, MOS FET gate drive AGC output, keyed AGC, differential IF amplifier, buffer amplifier for oscillation, local oscillation.

Features

- By using the keyed AGC system, which is effective in improving the sensitivity suppression characteristic, in combination with the antenna damping AGC (PIN diode driver on chip) and MOS FET 2nd gate drive AGC, the intermodulation characteristic for a large undesired signal is greatly improved. It is also possible to use the keyed AGC system in combination with the antenna damping AGC or MOS FET 2nd gate drive AGC.
- The temperature characteristic and noise figure are improved. The same supply voltage makes it easy to use the LA1175, 1175M.

Package Dimensions

unit: mm

3020A-SIP16

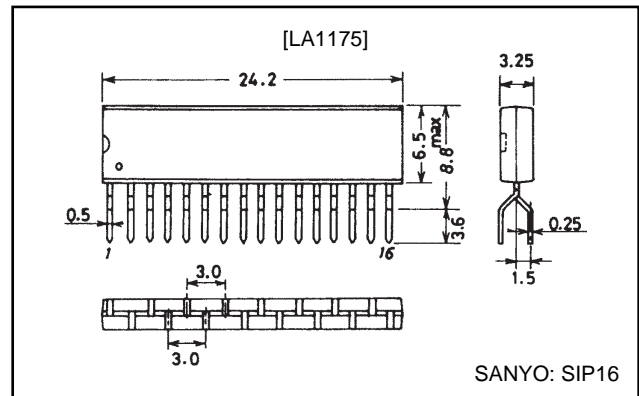

unit: mm

3035A-MFP16

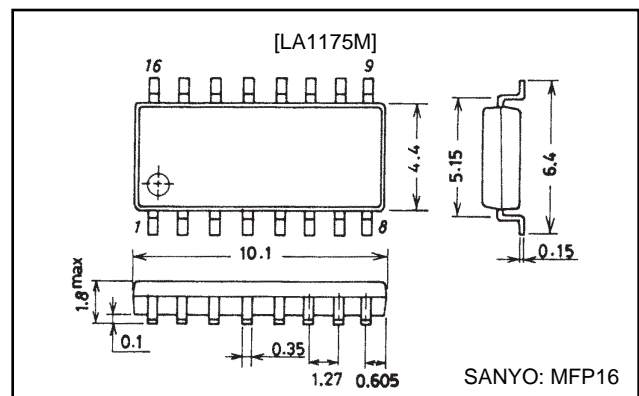

Specifications

Maximum Ratings at Ta=25°C

Parameter	Symbol	Conditions	Ratings	Unit
Maximum supply voltage	VCC max	Pins 4, 14	9.5	V
		Pins 8, 9	15	V
Allowable power dissipation	Pd max	LA1175 : Ta≤70°C	460	mW
		LA1175M : Ta≤70°C Mounted on PCB (bakelite) of 40mm×48mm×1.8mm ²	435	mW
Operating temperature	Topr		-20 to +70	°C
Storage temperature	Tstg		-40 to +125	°C

LA1175, 1175M

Operating Conditions at $T_a=25^\circ\text{C}$

Parameter	Symbol	Conditions	Ratings	Unit
Recommended supply voltage	V_{CC}	Pin 4, 8, 9, 14	8	V
Operating voltage range	$V_{CC\text{ op}}$		8 to 9	V

Electrical Characteristics at $T_a=25^\circ\text{C}$, $V_{CC}=8\text{V}$, See specified Test Circuit.

Parameter	Symbol	Conditions	Ratings			Unit
			min	typ	max	
Current drain	I_{CC}	Pins 4, 8, 9, 14 : no input	23.0	28.0	33.0	mA
AGC high-level voltage	V_{AGCH}	$V_{IN}=0\text{dB}\mu$, $V_{CL}=4\text{V}$	7.6	7.9		V
AGC low-level voltage	V_{AGCL}	$V_{IN}=100\text{dB}\mu$, $V_{CL}=4\text{V}$		0.2	0.7	V
IF input resistance	R_{IN}		260	330	400	Ω
AGC control input	V_{CL7}	$V_{IN}=100\text{dB}\mu$, $V_{AGC}=7\text{V}$		0.25	0.5	V
	V_{CL2}	$V_{IN}=100\text{dB}\mu$, $V_{AGC}=2\text{V}$	1.1	1.6	2.1	V
Voltage gain	A_V	LA1175 : $V_{IN}=75\text{dB}\mu$	99	102	105	$\text{dB}\mu$
		LA1175M : $V_{IN}=75\text{dB}\mu$	97	100	103	$\text{dB}\mu$
Input limiting voltage	V_{INlim}	LA1175 : Referenced to $V_{IN}=110\text{dB}\mu$	81	88	95	$\text{dB}\mu$
		LA1175M : Referenced to $V_{IN}=110\text{dB}\mu$	80	87	94	$\text{dB}\mu$
AGC input voltage	V_{iAGC}	$V_{AGC}=2\text{V}$	67	74	81	$\text{dB}\mu$
Saturation output voltage	V_{OUT}	LA1175 : $V_{IN}=110\text{dB}\mu$	110	114		$\text{dB}\mu$
		LA1175M : $V_{IN}=110\text{dB}\mu$	100	113		$\text{dB}\mu$
OSC BUFF output	$V_{OSC\text{ BUFF}}$	1k Ω load	105	109		$\text{dB}\mu$
ANT damping drive current	I_{ANT-D}	$V_{IN}=100\text{dB}\mu$	4.5	6.0	8.0	mA

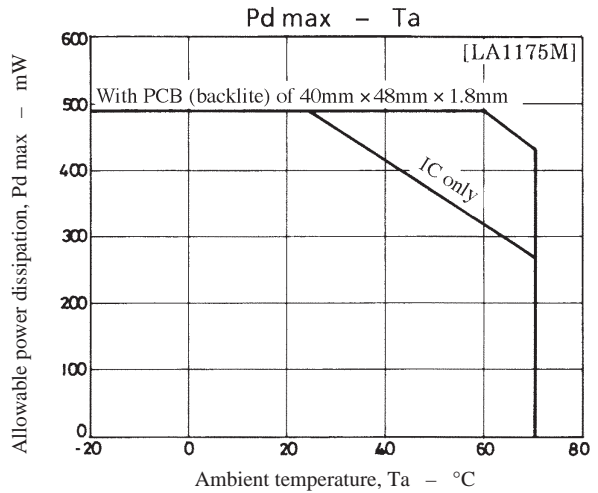
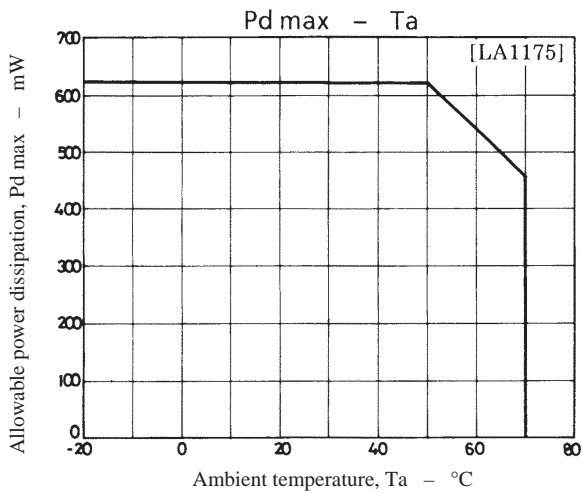

LA1175, 1175M

Equivalent Circuit Block Diagram and Peripheral Circuit : LA1175

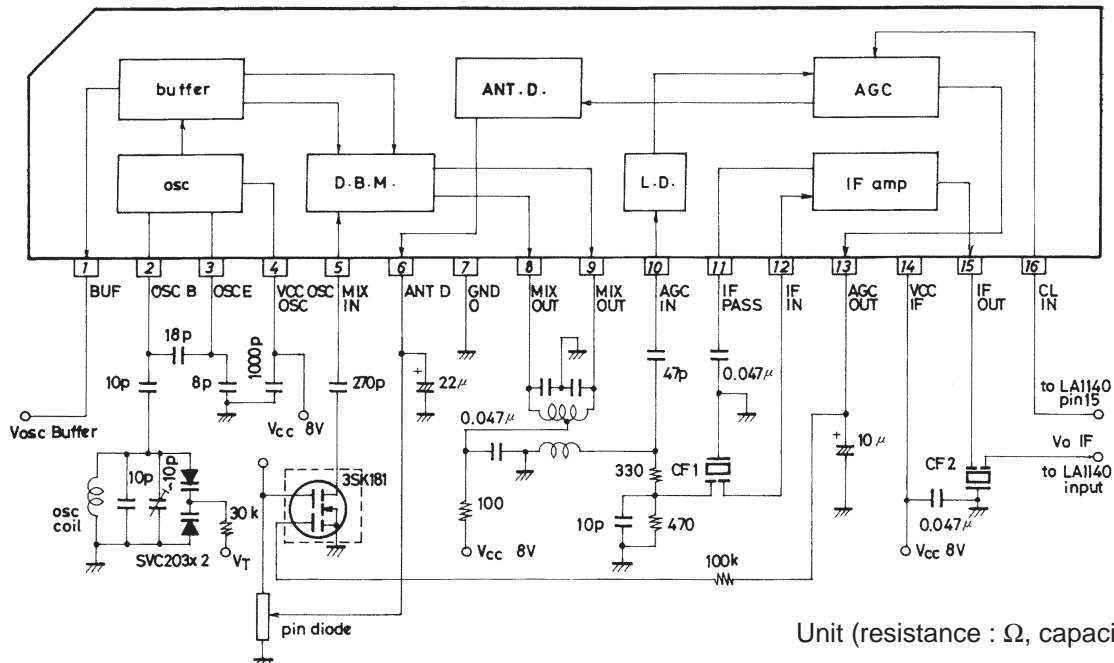

Unit (resistance : Ω , capacitance : F)

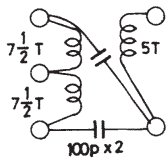

MIX output IFT 10mm □
 YT-20577 (Mitsumi)
 014-022 (Sumida)
 EKSC-30174FCU (Toko)
 OSC coil YT-30013 (Mitsumi)
 WIRE 0.8 ϕ inside dia. 6mm ϕ 4T air core

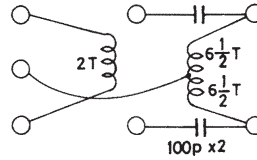

MIX output (small-sized)
 47K-074-124 (Sumida)

Equivalent Circuit Block Diagram and Peripheral Circuit : LA1175M

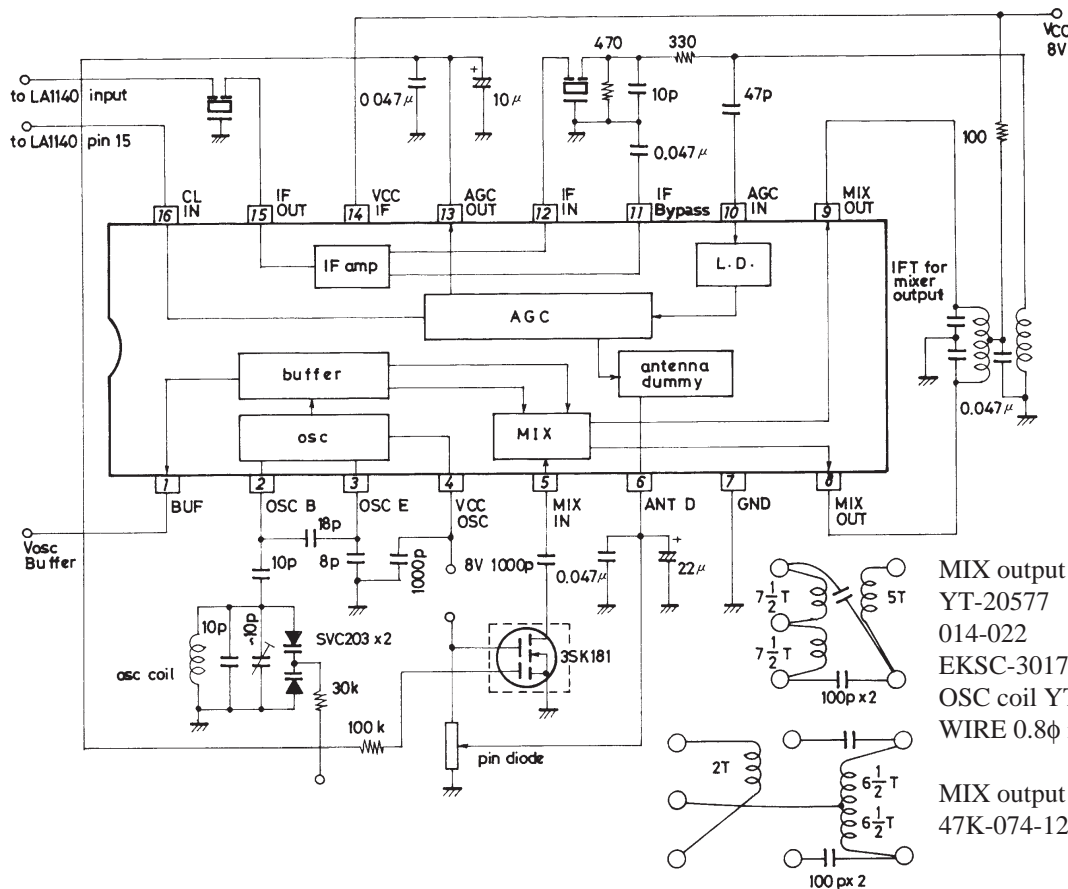

MIX output IFT 10mm □
 YT-20577 (Mitsumi)
 014-022 (Sumida)
 EKSC-30174FCU (Toko)
 OSC coil YT-30013 (Mitsumi)
 WIRE 0.8 ϕ inside dia. 6mm ϕ 4T air core

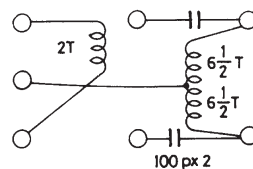

MIX output (small-sized)
 47K-074-124 (Sumida)

Unit (resistance : Ω , capacitance : F)

Internal Connection Diagram : LA1175

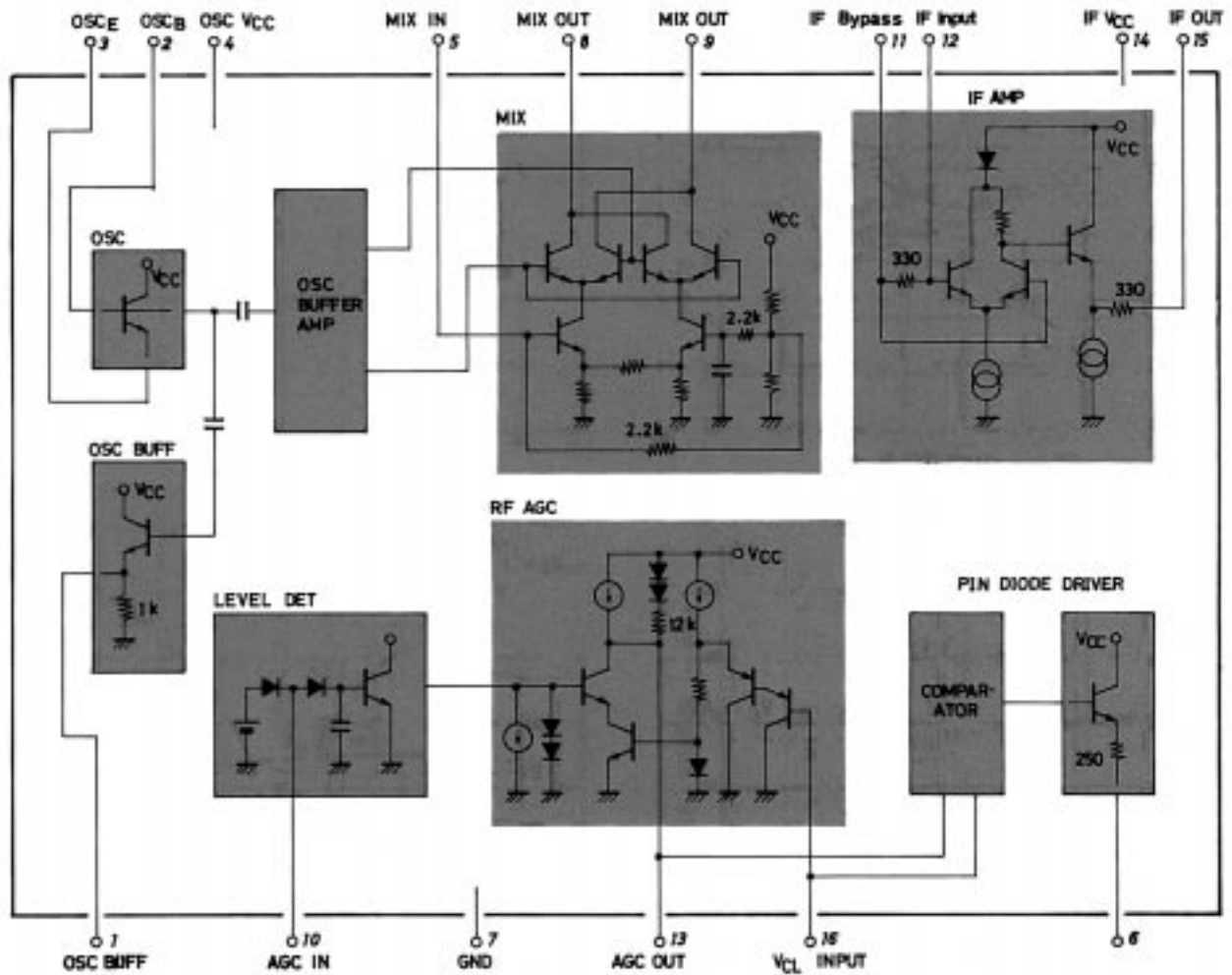

Unit (resistance : Ω , capacitance : F)

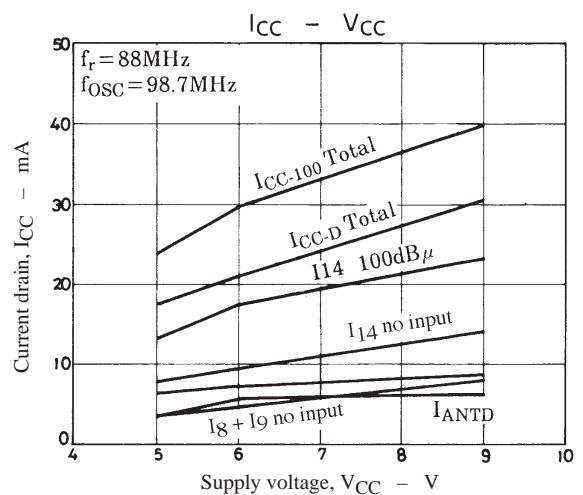
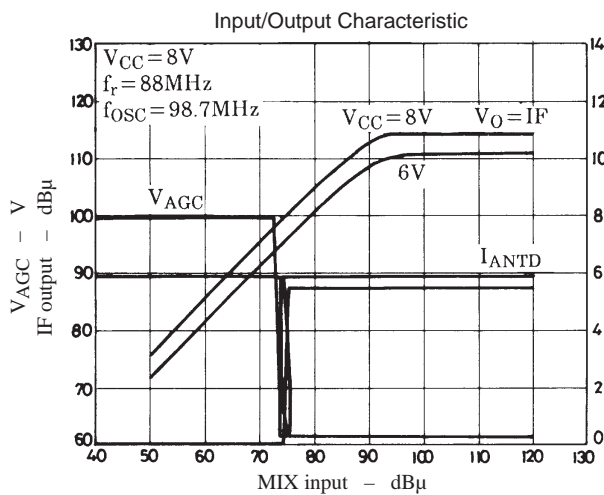

LA1175, 1175M

MIX BLOCK Input/Output Characteristic

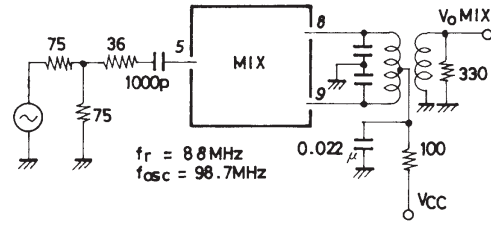
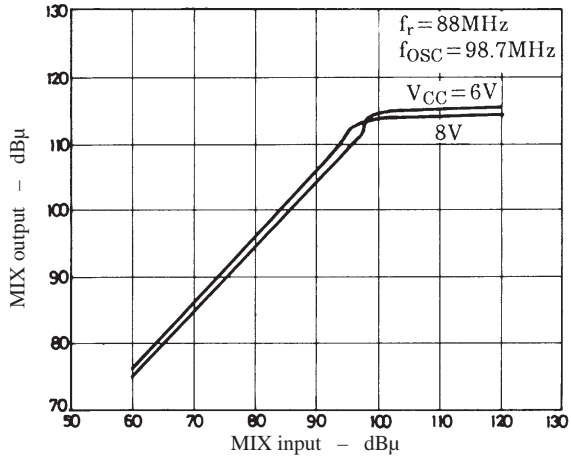

Unit (resistance : Ω, capacitance : F)

IF BLOCK Input/Output Characteristic

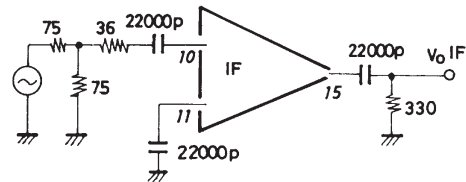
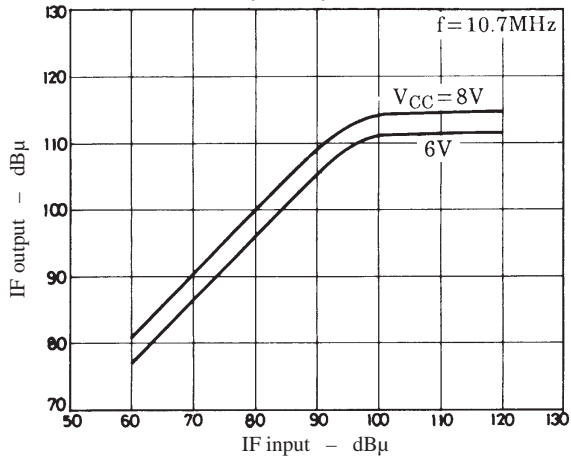

V_{AGC} Input/Output Characteristic (AGC BLOCK)

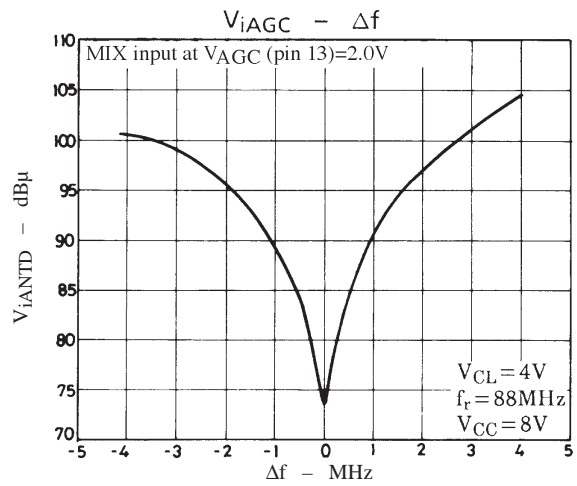
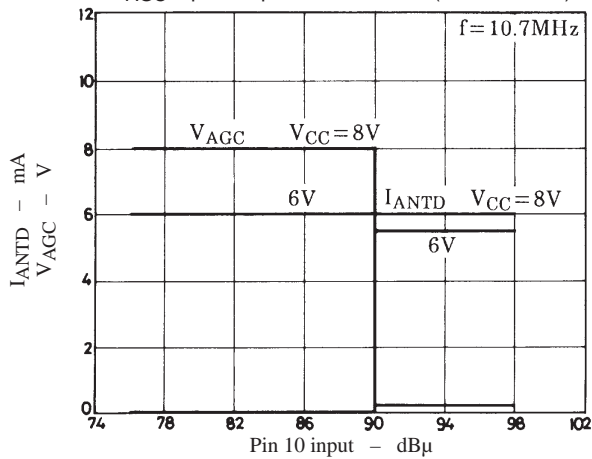

V_{AGC} - C10

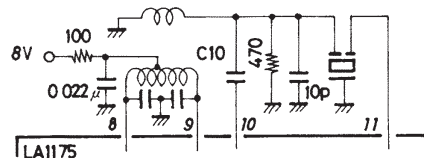
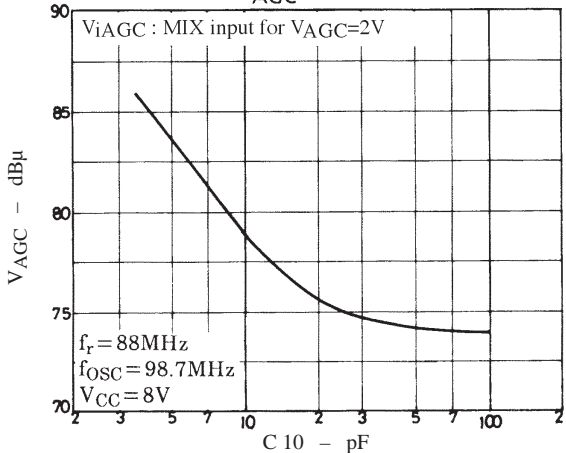

Unit (resistance : Ω, capacitance : F)

LA1175, 1175M

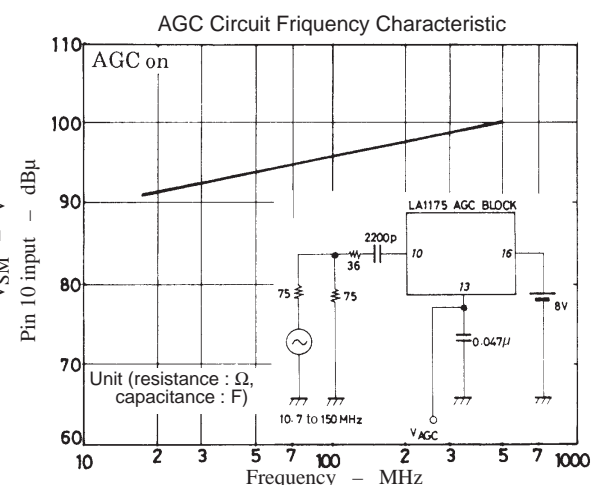
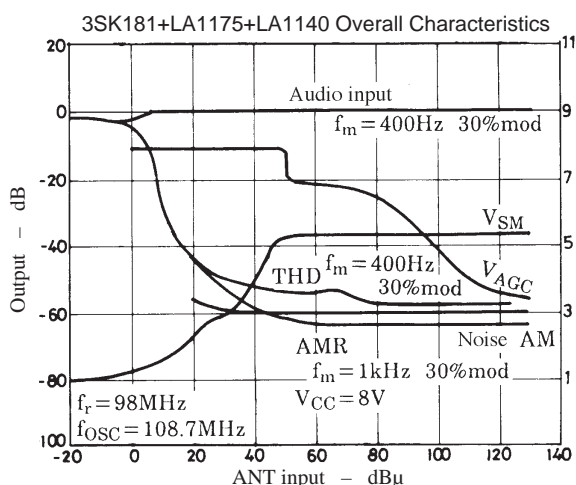
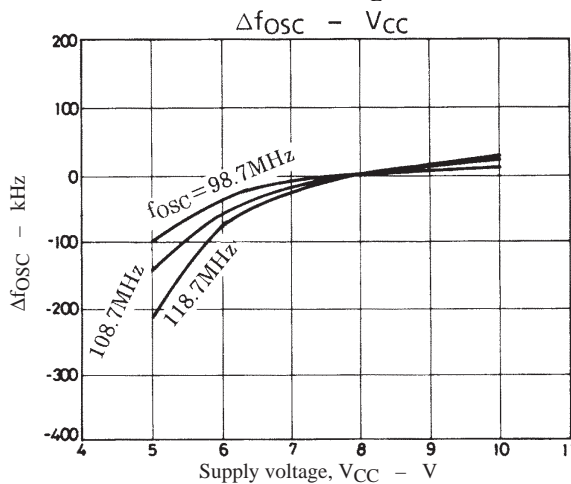
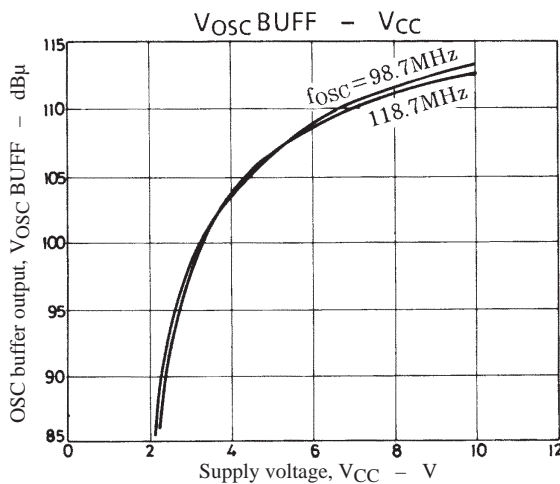
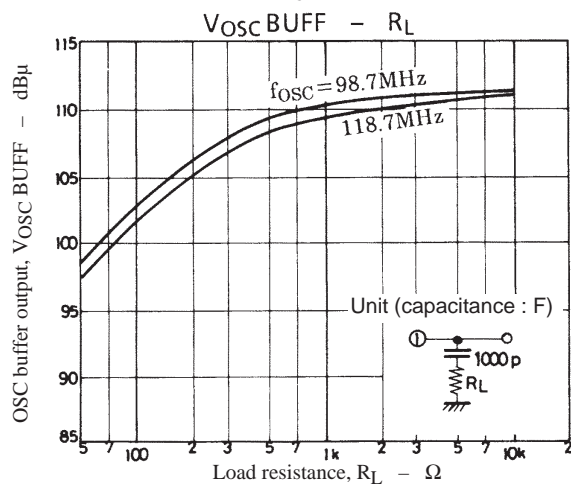
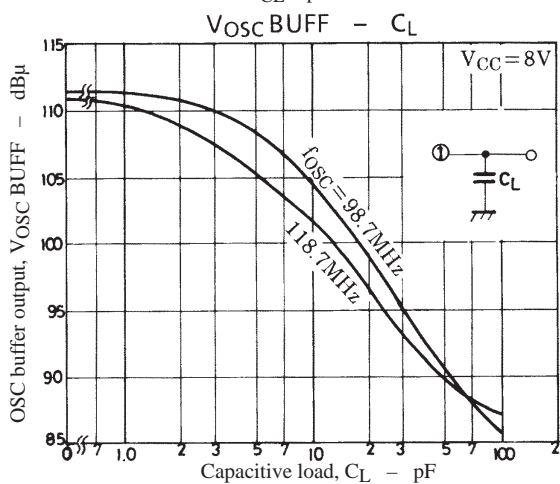
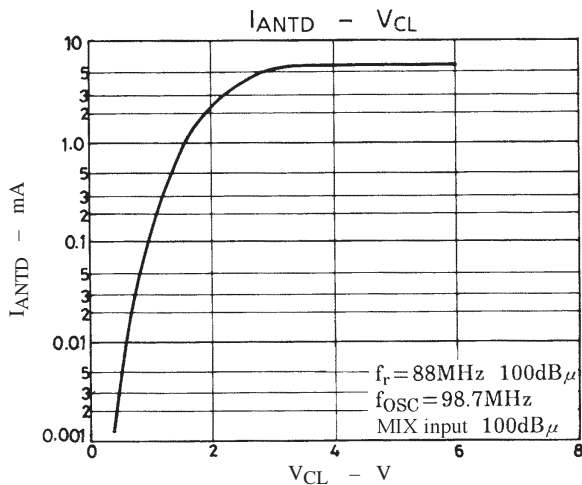
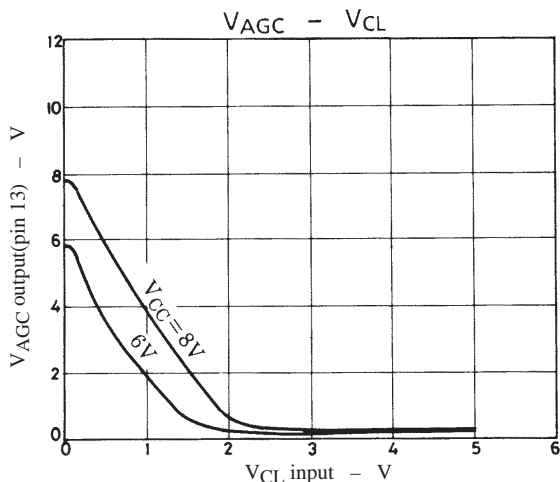

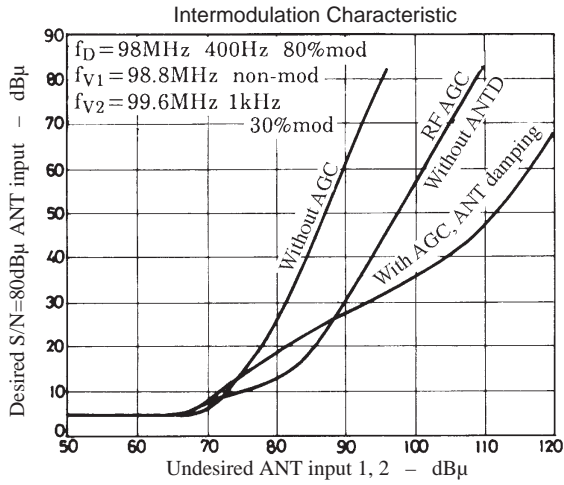

Intermodulation dummy used

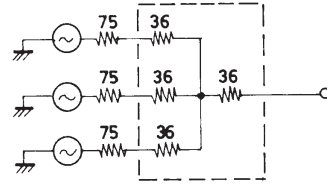

Unit (resistance : Ω)

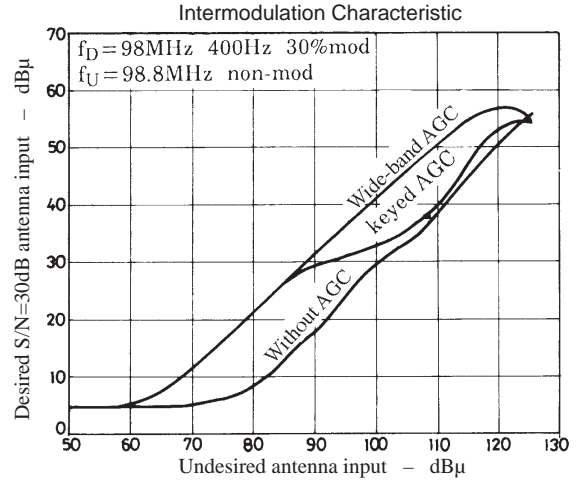
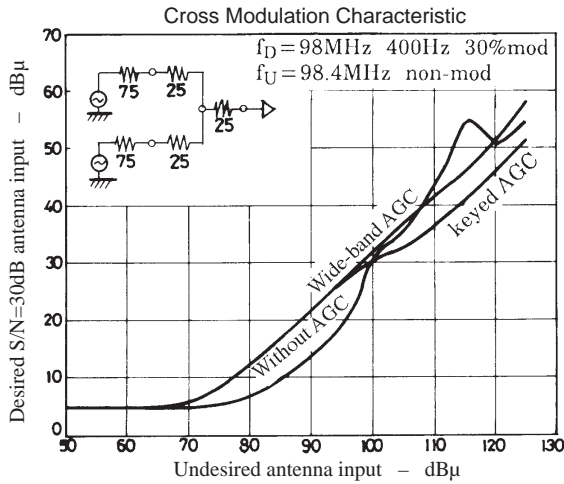

Improvement of IM characteristic in strong undesired input signal mode when ANT damping AGC is used (LA1174).

Test conditions

- f_D : 99.1MHz, $f_m=400\text{Hz}$ 100% mod
- f_{U1} : 97.9MHz non-mod SG open 132dBμ
- f_{U2} : 96.7MHz $f_m=1\text{kHz}$ 100% mod

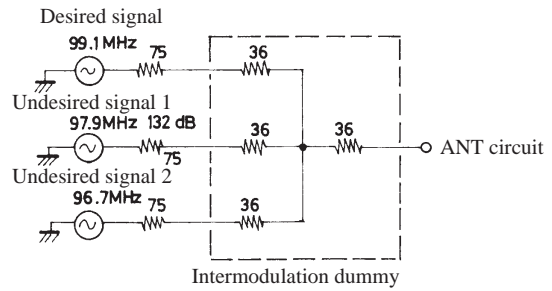

Unit (resistance : Ω)

Cross point

The open input level of undesired signal 2 at which the IM output and desired signal output are at the same level.

- | | | |
|-----------------------|----------------------|--|
| IM output | • Desired signal | : Non-mod at each specified input |
| | • Undesired signal 1 | : Non-mod at input 132dB μ (SG open) |
| | • Undesired signal 2 | : 100% mod with input variable |
| Desired signal output | • Desired signal | : 100% at each specified input |
| | • Undesired signal 1 | : Non-mod at input 132dB μ (SG open) |
| | • Undesired signal 2 | : Non-mod with input variable |

Desired input level		50dB μ	60dB μ	70dB μ	80dB μ	
Cross point	With ANT damping RF AGC and ANTD AGC	90.5dB μ	109dB μ	123dB μ	Test impossible	Refer to Fig. A.
	Without ANT damping RF AGC only	59.5dB μ	72dB μ	89dB μ	98dB μ	Refer to Fig. B.
Improvement		31dB	37dB	34dB		

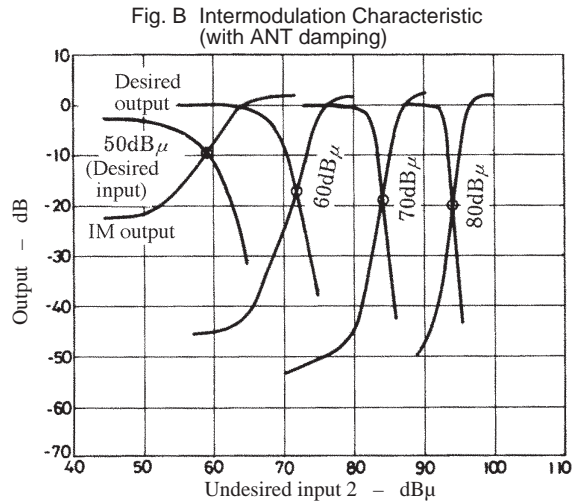
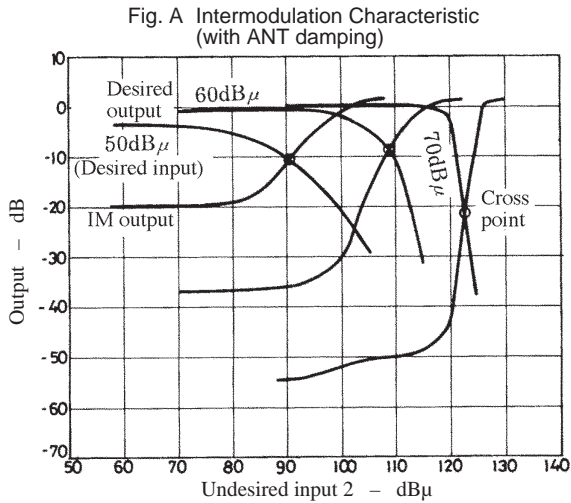

Solid line $f_D=99.1\text{MHz}$ $f_m=400\text{Hz}$ 700% mod
 $f_{U1}=97.9\text{MHz}$ non-mod
 132dB μ (SG open)
 $f_{U2}=96.7\text{MHz}$ non-mod
 Broken line $f_D=99.1\text{MHz}$ non-mod
 $f_{U1}=97.9\text{MHz}$ non-mod
 132dB μ (SG open)
 $f_{U2}=96.7\text{MHz}$ 1kHz 100% mod

Solid line $f_D=99.1\text{MHz}$ $f_m=400\text{Hz}$ 700% mod
 $f_{U1}=97.9\text{MHz}$ non-mod
 132dB μ (SG open)
 $f_{U2}=96.7\text{MHz}$ non-mod
 Broken line $f_D=99.1\text{MHz}$ non-mod
 $f_{U1}=97.9\text{MHz}$ non-mod
 132dB μ (SG open)
 $f_{U2}=96.7\text{MHz}$ 1kHz 100% mod

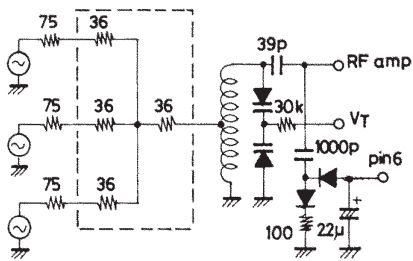

Intermodulation dummy

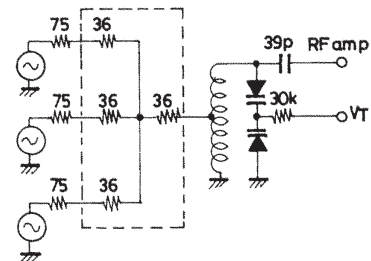

Intermodulation dummy

Unit (resistance : Ω , capacitance F)

LA1175, 1175M

3SK181+LA1175+LA1140 Cross Modulation Characteristic
 (Sensitivity Suppression Characteristic in strong undesired input signal mode)

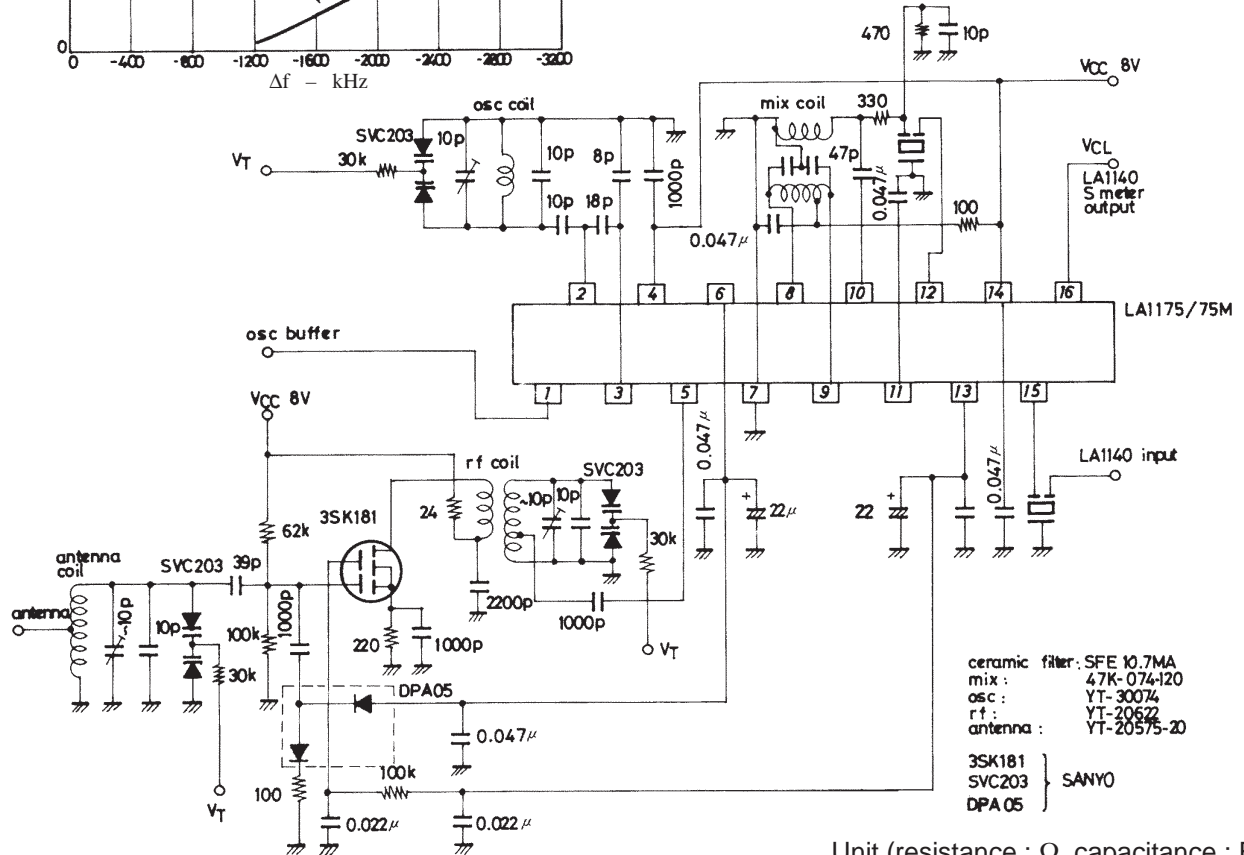
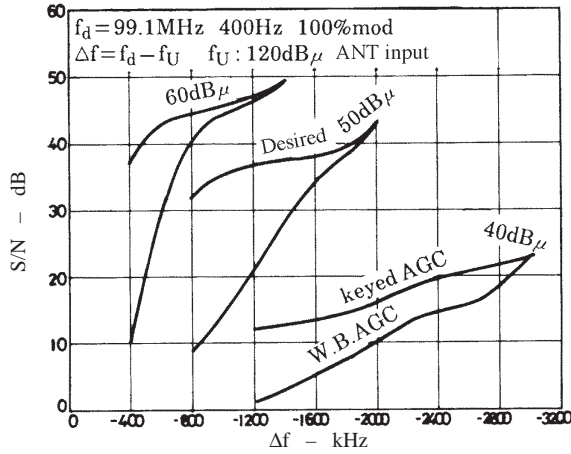

Unit (resistance : Ω, capacitance : F)

Test Circuit

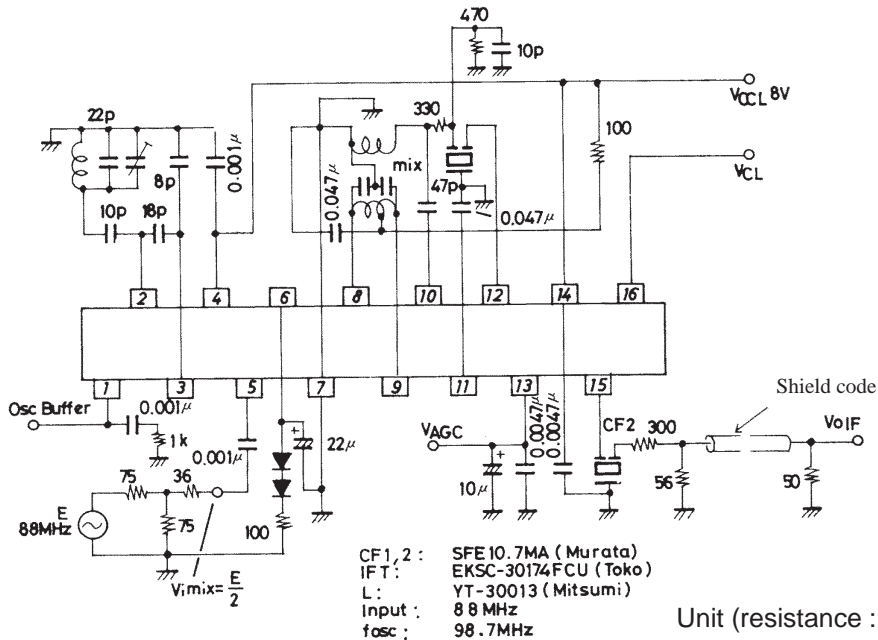

Unit (resistance : Ω, capacitance : F)

Temperature Characteristics (4)

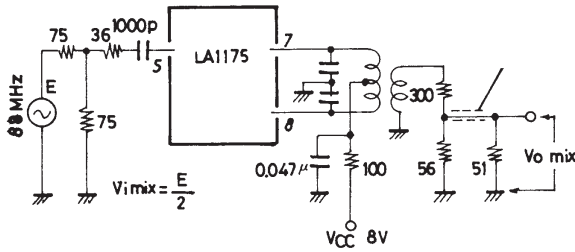

Temperature Characteristics (5)

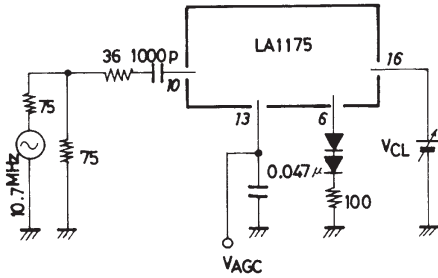

Temperature Characteristics (6)

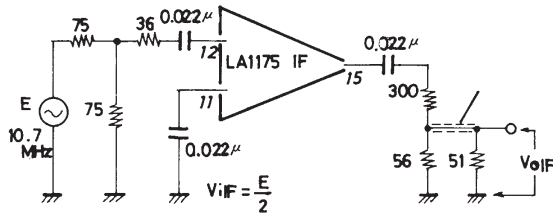

Temperature Characteristics (7)

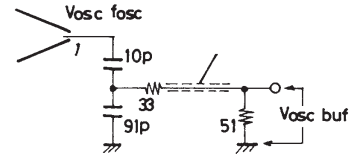

Unit (resistance : Ω, capacitance : F)

Temperature Characteristic (1)

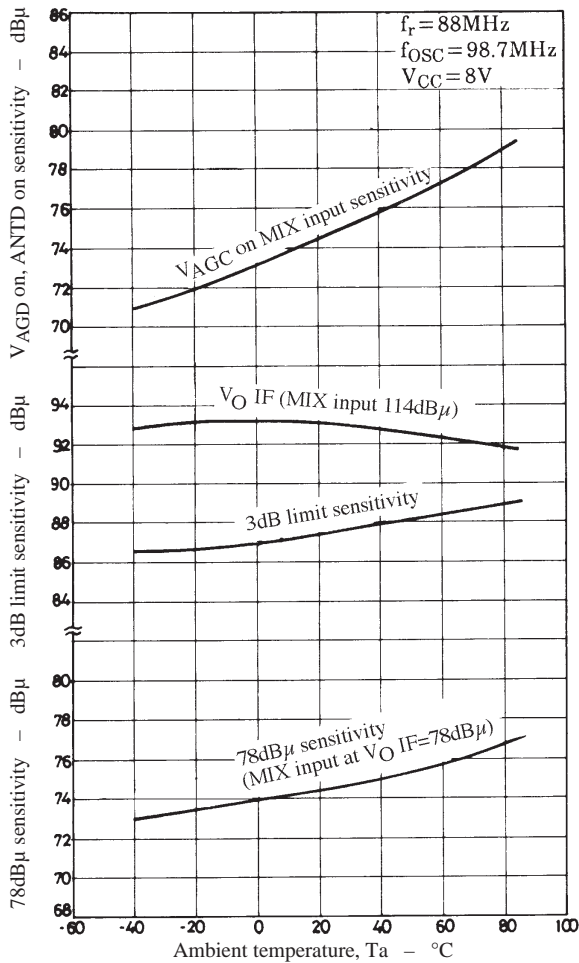

Temperature Characteristic (2)

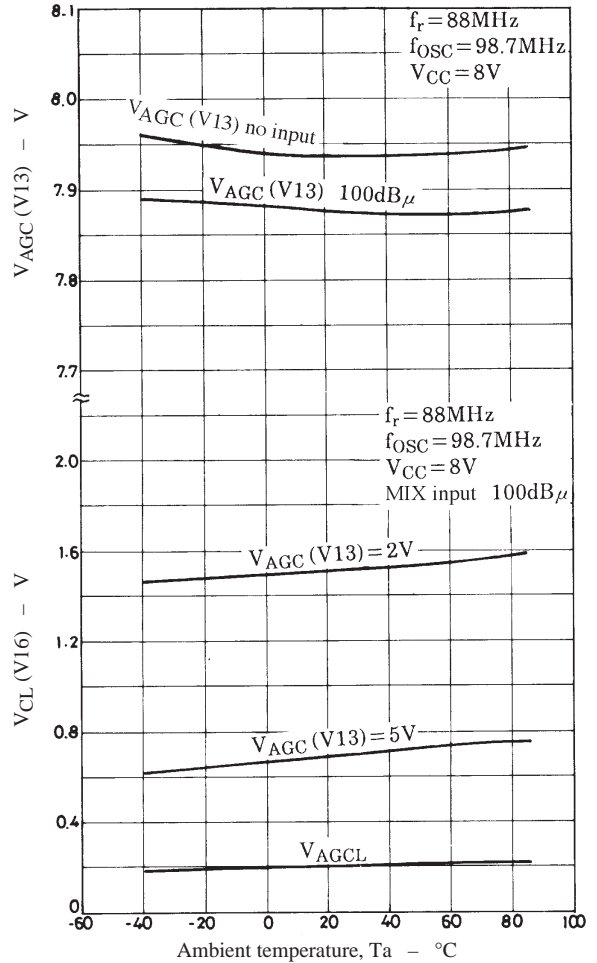

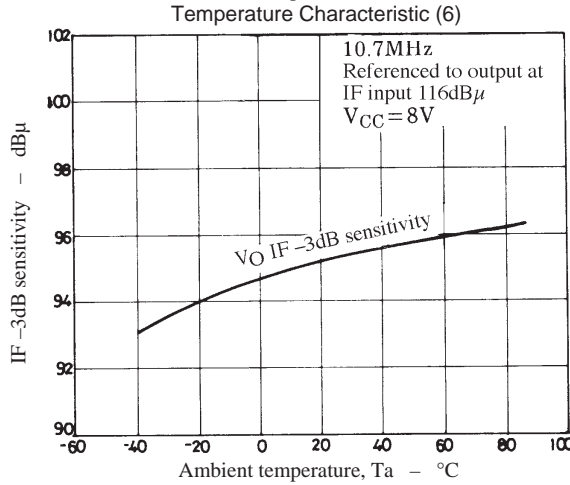
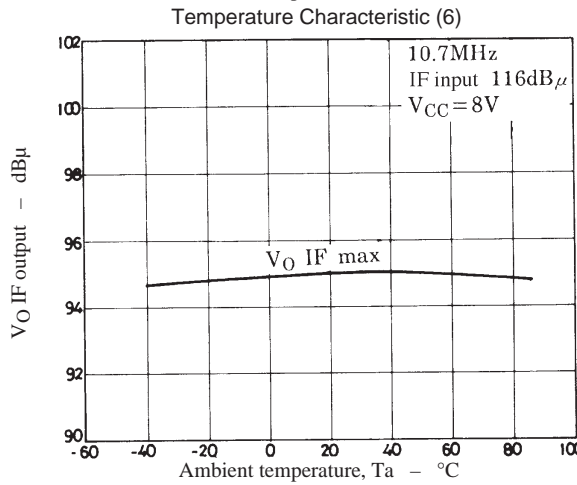
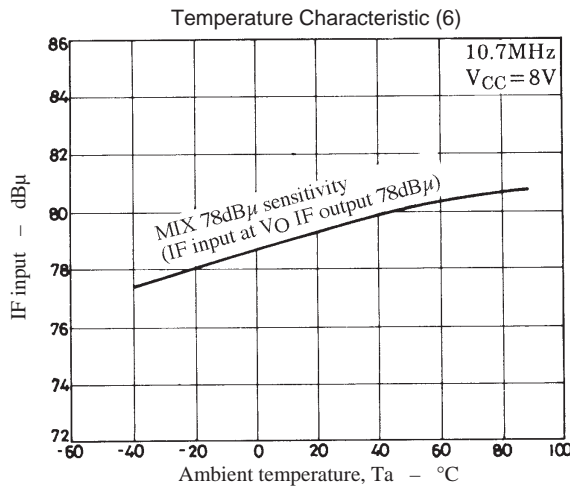
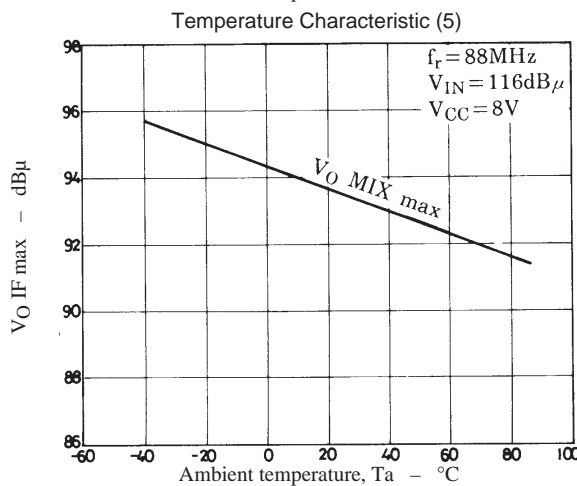
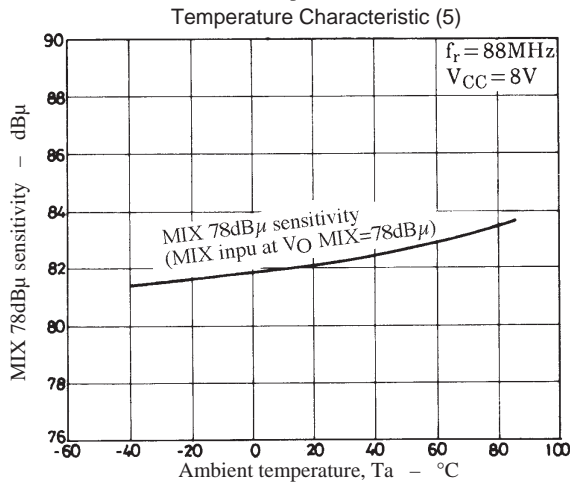
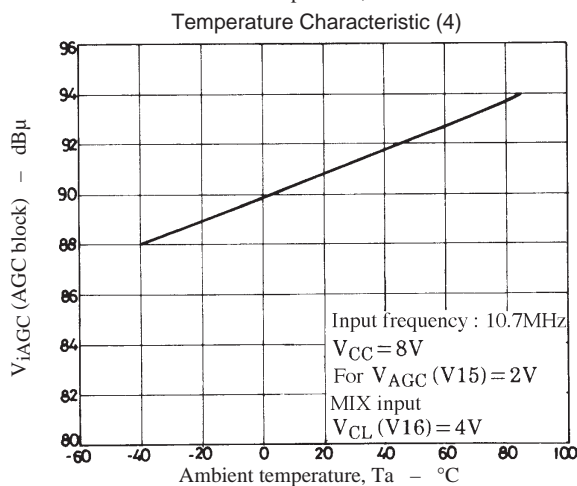
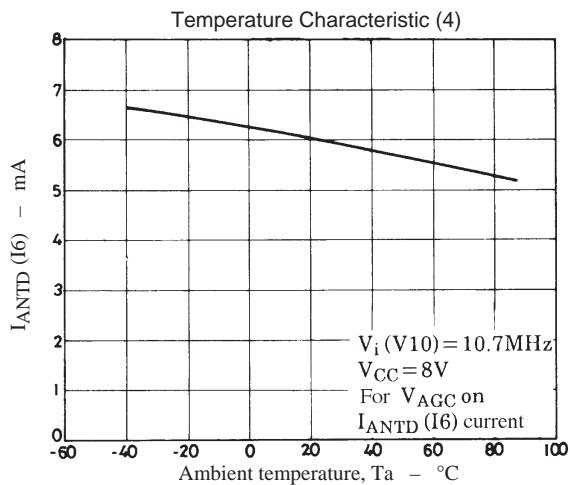
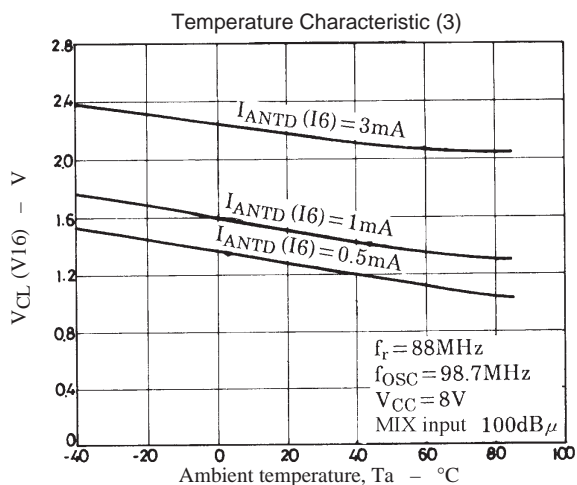

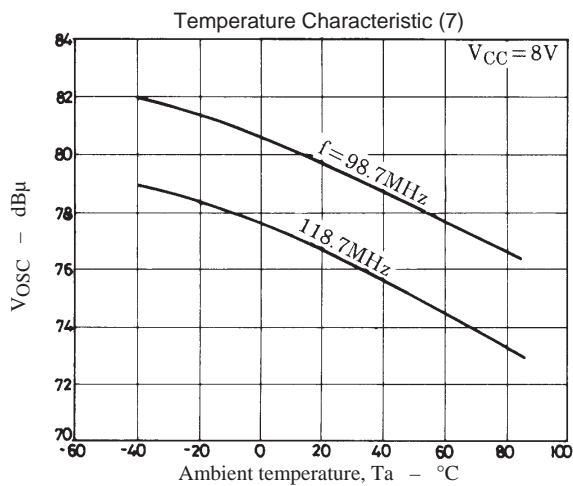
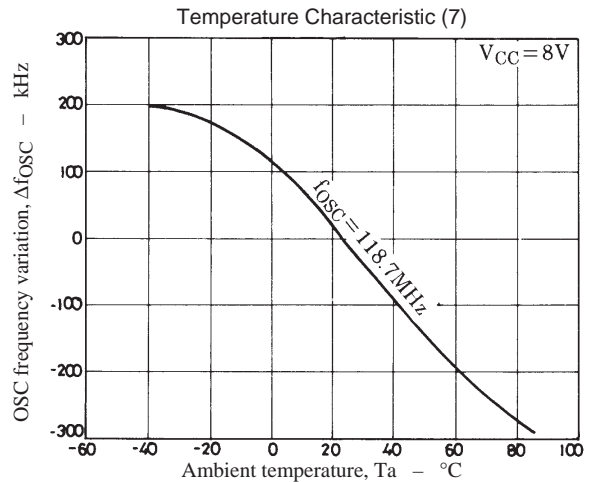
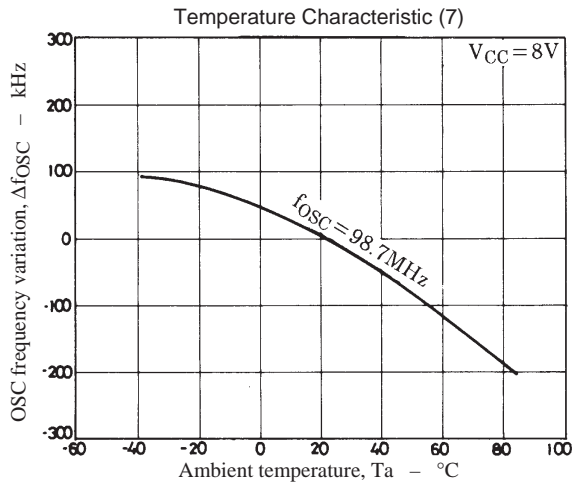

Description of AGC circuit in the LA1175, 1175M

The LA1175, 1175M are designed so that AGC is operated in the order shown below.

ANT damping (PIN diode) → MOS FET 2nd gate voltage control
 (Attenuation)20dB (Attenuation)60dB

The following are the reasons why AGC is operated in this order.

- (1) When a signal of 110dBμ or greater is applied to the varactor in the ANT circuit, intermodulation may occur. In this case, if AGC is operated in the order of MOS FET 2nd gate control AGC → ANT damping (PIN diode), the input to the varactor in the ANT circuit is not restricted unless a strong signal with AGC attenuation 60dB or greater is given. Therefore, AGC should be operated in the order shown above.
- (2) If the two AGC loops (AGC loop (ANT damping) and AGC loop (MOS FET 2nd gate control)) are operated simultaneously, the transient response of AGC loses stability. Therefore, the order shown below is impracticable.

MOS FET 2nd gate control → ANT damping → MOS FET 2nd gate control.

Relation between keyed AGC and two AGC loops

For the LA1170, keyed AGC provides AGC attenuation control (RF MOS FET 2nd gate). For the LA1175, 1175M, however, there are two AGC loops as shown above. Therefore, keyed AGC must be applied to both of the two AGC loops. The LA1175, 1175M contain the ANT damping circuit to improve intermodulation in a strong field, but the prevention of intermodulation in a strong field and the improvement of the sensitivity suppression characteristic by keyed AGC are mutually exclusive as mentioned below.

Conditions	Desired signal	Weak field
	Undesired signals 1, 2	Strong field (Field strength in which the ANT circuit may cause intermodulation to occur)

If keyed AGC is operated to cause AGC-OFF mode to be entered when a desired signal is received, the varactor in the ANT circuit may be distorted and intermodulation may occur, which means that it is meaningless for the LA1175, 1175M to contain the ANT damping circuit because it produces no effect. Therefore, the effect of the keyed AGC circuit in the LA1175, 1175M on the ANT damping circuit is made less than that in the LA1170 so that the above-mentioned problem does not arise. However, if the LA1175, 1175M are used under the same conditions as for the LA1170 (no ANT damping, pin 6 open), keyed AGC is operated in the same manner as for the LA1170.

Application circuit used in a very strong field

Since the LA1175, 1175M are designed to be operated from single supply, the dynamic range of the MIX output becomes narrower as compared with the dual-supply type ($V_{CC\ MIX}=12V$, other=8V) heretofore in use. IF an adjacent interference channel signal is very strong, the intermodulation characteristic at $\Delta f=400kHz$ is deteriorated, because the dynamic range of the MIX output exceeds the limit, which causes a distortion to occur.

The following three countermeasures are available.

1. Q of the MIX coil is made higher to provide a higher selectivity.
(Must be balanced with the detection band of the wide-band AGC)
2. The LA1175, 1175M are operated from dual supplies (Most ideal).
3. The application circuit shown below is used.

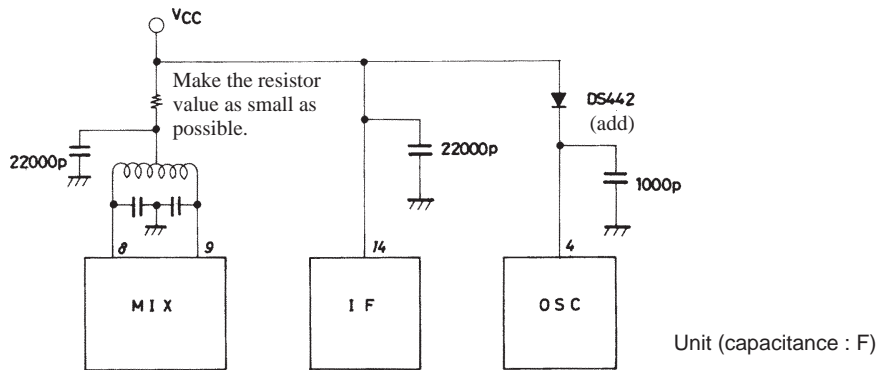

■ No products described or contained herein are intended for use in surgical implants, life-support systems, aerospace equipment, nuclear power control systems, vehicles, disaster/crime-prevention equipment and the like, the failure of which may directly or indirectly cause injury, death or property loss.

■ Anyone purchasing any products described or contained herein for an above-mentioned use shall:

- ① Accept full responsibility and indemnify and defend SANYO ELECTRIC CO., LTD., its affiliates, subsidiaries and distributors and all their officers and employees, jointly and severally, against any and all claims and litigation and all damages, cost and expenses associated with such use;
- ② Not impose any responsibility for any fault or negligence which may be cited in any such claim or litigation on SANYO ELECTRIC CO., LTD., its affiliates, subsidiaries and distributors or any of their officers and employees jointly or severally.

■ Information (including circuit diagrams and circuit parameters) herein is for example only; it is not guaranteed for volume production. SANYO believes information herein is accurate and reliable, but no guarantees are made or implied regarding its use or any infringements of intellectual property rights or other rights of third parties.

This catalog provides information as of September, 1997. Specifications and information herein are subject to change without notice.