

SANYO	No.1700E	L780S00 Series
5 to 24V 1A 5-Pin Voltage Regulators with Strobe Pin		

Features

- . Output voltage

L780S05:	5V	L780S06:	6V	L780S07:	7V
L780S08:	8V	L780S09:	9V	L780S10:	10V
L780S12:	12V	L780S15:	15V	L780S18:	18V
L780S20:	20V	L780S24:	24V		
- . The strobe pin can be used to turn ON/OFF output voltage (active-low).
- . 1A output current.
- . On-chip thermal protector.
- . On-chip overcurrent limiter.
- . On-chip ASO protector.
- . The use of package TO220-5H (5 pins) facilitates mounting and thermal design.

[Common to L780S00 series]

Maximum Ratings at Ta=25°C

				unit
Maximum Supply Voltage	V_{CCmax}	Pin 1	35	V
Strobe Input Voltage	V_{STmax}	Pin 4	18	V
Strobe Input Current	I_{STmax}	Pin 4	5	mA
Allowable Power Dissipation	P_{dmax}		1.75	W
		$T_c=25^\circ C$	20	W
Thermal Resistance	θ_{j-c}		5	$^\circ C/W$
Operating Temperature	T_{opr}		-20 to +80	$^\circ C$
Storage Temperature	T_{stg}		-55 to +150	$^\circ C$

Strobe Operating Characteristics at Ta=25°C

		unit
Strobe Operation Start Voltage	$V_{st(on)}$	2.4 V
Strobe Operation Stop Voltage	$V_{st(off)}$	0.5 V

DC Characteristics Test Circuit (Common to L780S00 series)

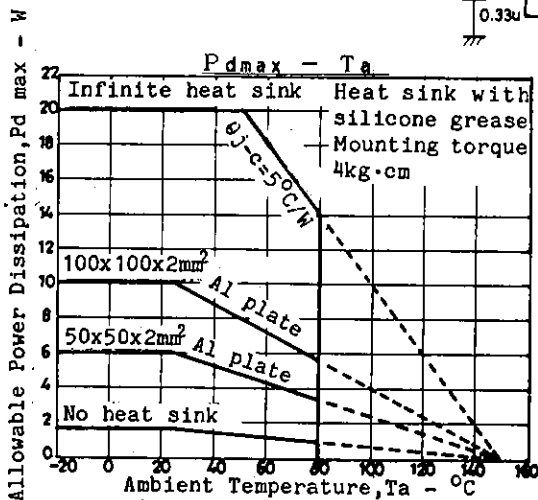
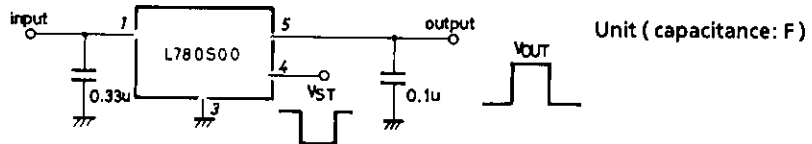

Package Dimensions (unit: mm) 3079

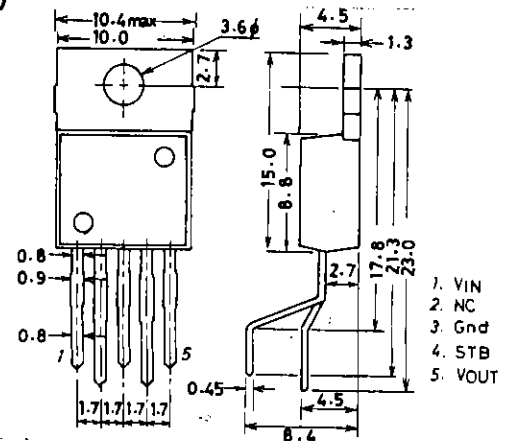

1. VIN
2. NC
3. Gnd
4. STB
5. VOUT

SANYO Electric Co., Ltd. Semiconductor Business Headquarters
TOKYO OFFICE Tokyo Bldg., 1-10, 1 Chome, Ueno, Taito-ku, TOKYO, 110 JAPAN

8119YT/ N307TA/9047KI/7086KI/4045MW, TS No. 1700-1/9

L780S00 Series

L780S05

Recommended Operating Conditions at $T_a=25^\circ\text{C}$

Parameter	Symbol	Value	Unit
Input Voltage Range	V_{IN}	7.5 to 20.0	V
Output Current Range	I_o	5 to 1000	mA

Operating Characteristics at $T_j=25^\circ\text{C}, V_{IN}=10\text{V}, I_o=500\text{mA}, V_{st}=0\text{V}, *T_a=25^\circ\text{C}$

Parameter	Symbol	Conditions	min	typ	max	unit
Output Voltage 1	V_{o1}		4.8	5.0	5.2	V
Line Regulation 1	ΔV_{o1n1}	$7\text{V} \leq V_{IN} \leq 25\text{V}$		3	100	mV
Line Regulation 2	ΔV_{o1n2}	$8\text{V} \leq V_{IN} \leq 12\text{V}$		1	50	mV
Load Regulation 1	ΔV_{o1d1}	$5\text{mA} \leq I_o \leq 1.5\text{A}$			100	mV
Load Regulation 2	ΔV_{o1d2}	$250\text{mA} \leq I_o \leq 750\text{mA}$			50	mV
Output Voltage 2	V_{o2}	$7\text{V} \leq V_{IN} \leq 20\text{V}, 5\text{mA} \leq I_o \leq 1\text{A}$	4.75		5.25	V
Current Dissipation	I_{cc}				8.0	mA
Current Dissipation Variation (Line)	ΔI_{cc1n}	$7\text{V} \leq V_{IN} \leq 25\text{V}$			1.3	mA
Current Dissipation Variation (Load)	ΔI_{cc1d}	$5\text{mA} \leq I_o \leq 1\text{A}$			0.5	mA
Output Noise Voltage	V_{NO}	$10\text{Hz} \leq f \leq 100\text{kHz}^*$		40		μV
Ripple Rejection	R_r	$f=120\text{Hz}, 8\text{V} \leq V_{IN} \leq 18\text{V}$	62	78		dB
Dropout Voltage	V_{drop}	$I_o=1\text{A}$		2.0		V
Output Short Current	I_{os}	$V_{IN}=35\text{V}$		0.75		A
Peak Output Current	I_{op}			2.2		A
Output Voltage at Strobe Mode	$V_{o(ston)}$	$V_{IN}=35\text{V}, V_{st}=5\text{V}, I_o=0, *$			0.8	V
Current Dissipation at Strobe Mode	$I_{cc(ston)}$	"			3.0	mA
Strobe Input Current	I_{st}	"			1.0	mA

L780S06

Recommended Operating Conditions at $T_a=25^\circ\text{C}$

Parameter	Symbol	Value	Unit
Input Voltage Range	V_{IN}	8.5 to 21.0	V
Output Current Range	I_o	5 to 1000	mA

Operating Characteristics at $T_j=25^\circ\text{C}, V_{IN}=11\text{V}, I_o=500\text{mA}, V_{st}=0\text{V}, *T_a=25^\circ\text{C}$

Parameter	Symbol	Conditions	min	typ	max	unit
Output Voltage 1	V_{o1}		5.75	6.0	6.25	V
Line Regulation 1	ΔV_{o1n1}	$8\text{V} \leq V_{IN} \leq 25\text{V}$		5	120	mV
Line Regulation 2	ΔV_{o1n2}	$9\text{V} \leq V_{IN} \leq 13\text{V}$		1.5	60	mV
Load Regulation 1	ΔV_{o1d1}	$5\text{mA} \leq I_o \leq 1.5\text{A}$			120	mV
Load Regulation 2	ΔV_{o1d2}	$250\text{mA} \leq I_o \leq 750\text{mA}$			60	mV
Output Voltage 2	V_{o2}	$8\text{V} \leq V_{IN} \leq 21\text{V}, 5\text{mA} \leq I_o \leq 1\text{A}$	5.7		6.3	V
Current Dissipation	I_{cc}				8.0	mA
Current Dissipation Variation (Line)	ΔI_{cc1n}	$8\text{V} \leq V_{IN} \leq 25\text{V}$			1.3	mA
Current Dissipation Variation (Load)	ΔI_{cc1d}	$5\text{mA} \leq I_o \leq 1\text{A}$			0.5	mA
Output Noise Voltage	V_{NO}	$10\text{Hz} \leq f \leq 100\text{kHz}^*$		45		μV
Ripple Rejection	R_r	$f=120\text{Hz}, 9\text{V} \leq V_{IN} \leq 19\text{V}$	59	75		dB
Dropout Voltage	V_{drop}	$I_o=1\text{A}$		2.0		V
Output Short Current	I_{os}	$V_{IN}=35\text{V}$		0.75		A
Peak Output Current	I_{op}			2.2		A
Output Voltage at Strobe Mode	$V_{o(ston)}$	$V_{IN}=35\text{V}, V_{st}=5\text{V}, I_o=0, *$			0.8	V
Current Dissipation at Strobe Mode	$I_{cc(ston)}$	"			3.0	mA
Strobe Input Current	I_{st}	"			1.0	mA

L780S00 Series

L780S07

Recommended Operating Conditions at Ta=25°C

			unit
Input Voltage Range	V_{IN}	9.5 to 22.0	V
Output Current Range	I_o	5 to 1000	mA

Operating Characteristics at Tj=25°C, $V_{IN}=12V, I_o=500mA, V_{st}=0V, *Ta=25°C$

			min	typ	max	unit
Output Voltage 1	V_{o1}		6.72	7.0	7.28	V
Line Regulation 1	ΔV_{oln1}	$9V \leq V_{IN} \leq 26V$		6	140	mV
Line Regulation 2	ΔV_{oln2}	$10V \leq V_{IN} \leq 14V$		2	70	mV
Load Regulation 1	ΔV_{old1}	$5mA \leq I_o \leq 1.5A$			140	mV
Load Regulation 2	ΔV_{old2}	$250mA \leq I_o \leq 750mA$			70	mV
Output Voltage 2	V_{o2}	$9V \leq V_{IN} \leq 22V, 5mA \leq V_{IN} \leq 1A$	6.65		7.35	V
Current Dissipation	I_{cc}				8.0	mA
Current Dissipation Variation (Line)	ΔI_{ccln}	$9V \leq V_{IN} \leq 25V$			1.3	mA
Current Dissipation Variation (Load)	ΔI_{ccld}	$5mA \leq I_o \leq 1A$			0.5	mA
Output Noise Voltage	V_{NO}	$10Hz \leq f \leq 100kHz^*$			46	μV
Ripple Rejection	R_r	$f=120Hz, 10V \leq V_{IN} \leq 21V$	58		73	dB
Dropout Voltage	V_{drop}	$I_o=1A$			2.0	V
Output Short Current	I_{os}	$V_{IN}=35V$			0.75	A
Peak Output Current	I_{op}				2.2	A
Output Voltage at Strobe Mode	$V_{o(ston)}$	$V_{IN}=35V, V_{st}=5V, I_o=0, *$			0.8	V
Current Dissipation at Strobe Mode	$I_{cc(ston)}$	"			3.0	mA
Strobe Input Current	I_{st}	"			1.0	mA

L780S08

Recommended Operating Conditions at Ta=25°C

			unit
Input Voltage Range	V_{IN}	10.5 to 23.0	V
Output Current Range	I_o	5 to 1000	mA

Operating Characteristics at Tj=25°C, $V_{IN}=15V, I_o=500mA, V_{st}=0V, *Ta=25°C$

			min	typ	max	unit
Output Voltage 1	V_{o1}		7.7	8.0	8.3	V
Line Regulation 1	ΔV_{oln1}	$10.5V \leq V_{IN} \leq 25V$		6.0	160	mV
Line Regulation 2	ΔV_{oln2}	$11V \leq V_{IN} \leq 17V$		2.0	80	mV
Load Regulation 1	ΔV_{old1}	$5mA \leq I_o \leq 1.5A$			160	mV
Load Regulation 2	ΔV_{old2}	$250mA \leq I_o \leq 750mA$			80	mV
Output Voltage 2	V_{o2}	$10.5V \leq V_{IN} \leq 23V, 5mA \leq V_{IN} \leq 1A$	7.6		8.4	V
Current Dissipation	I_{cc}				8.0	mA
Current Dissipation Variation (Line)	ΔI_{ccln}	$10.5V \leq V_{IN} \leq 25V$			1.0	mA
Current Dissipation Variation (Load)	ΔI_{ccld}	$5mA \leq I_o \leq 1A$			0.5	mA
Output Noise Voltage	V_{NO}	$10Hz \leq f \leq 100kHz^*$			52	μV
Ripple Rejection	R_r	$f=120Hz, 11.5V \leq V_{IN} \leq 21.5V$	56		72	dB
Dropout Voltage	V_{drop}	$I_o=1A$			2.0	V
Output Short Current	I_{os}	$V_{IN}=35V$			0.75	A
Peak Output Current	I_{op}				2.2	A
Output Voltage at Strobe Mode	$V_{o(ston)}$	$V_{IN}=35V, V_{st}=5V, I_o=0, *$			0.8	V
Current Dissipation at Strobe Mode	$I_{cc(ston)}$	"			3.0	mA
Strobe Input Current	I_{st}	"			1.0	mA

L780S00 Series

L780S09

Recommended Operating Conditions at Ta=25°C

Parameter	Symbol	Value	Unit
Input Voltage Range	V _{IN}	11.5 to 25.0	V
Output Current Range	I _o	5 to 1000	mA

Operating Characteristics at Tj=25°C, V_{IN}=16V, I_o=500mA, V_{st}=0V, *Ta=25°C

Parameter	Symbol	Conditions	min	typ	max	Unit
Output Voltage 1	Vo1		8.64	9.0	9.36	V
Line Regulation 1	ΔVoln1	11.5V ≤ V _{IN} ≤ 25V		7	180	mV
Line Regulation 2	ΔVoln2	12V ≤ V _{IN} ≤ 20V		2	90	mV
Load Regulation 1	ΔVold1	5mA ≤ I _o ≤ 1.5A			180	mV
Load Regulation 2	ΔVold2	250mA ≤ I _o ≤ 750mA			90	mV
Output Voltage 2	Vo2	11.5V ≤ V _{IN} ≤ 24V, 5mA ≤ I _o ≤ 1A	8.55		9.45	V
Current Dissipation	I _{cc}				8.0	mA
Current Dissipation Variation (Line)	ΔI _{cc} ln	11.5V ≤ V _{IN} ≤ 26V			1.0	mA
Current Dissipation Variation (Load)	ΔI _{cc} ld	5mA ≤ I _o ≤ 1A			0.5	mA
Output Noise Voltage	V _{NO}	10Hz ≤ f ≤ 100kHz*		57		μV
Ripple Rejection	R _r	f=120Hz, 12V ≤ V _{IN} ≤ 22V	56	72		dB
Dropout Voltage	V _{drop}	I _o =1A		2.0		V
Output Short Current	I _{os}	V _{IN} =35V		0.75		A
Peak Output Current	I _{op}			2.2		A
Output Voltage at Strobe Mode	Vo(ston)	V _{IN} =35V, V _{st} =5V, I _o =0,*			0.8	V
Current Dissipation at Strobe Mode	I _{cc} (ston)	"			3.0	mA
Strobe Input Current	I _{st}	"			1.0	mA

L780S10

Recommended Operating Conditions at Ta=25°C

Parameter	Symbol	Value	Unit
Input Voltage Range	V _{IN}	13.0 to 25.0	V
Output Current Range	I _o	5 to 1000	mA

Operating Characteristics at Tj=25°C, V_{IN}=17V, I_o=500mA, V_{st}=0V, *Ta=25°C

Parameter	Symbol	Conditions	min	typ	max	Unit
Output Voltage 1	Vo1		9.6	10.0	10.4	V
Line Regulation 1	ΔVoln1	12.5V ≤ V _{IN} ≤ 28V		8	200	mV
Line Regulation 2	ΔVoln2	14V ≤ V _{IN} ≤ 20V		2.5	100	mV
Load Regulation 1	ΔVold1	5mA ≤ I _o ≤ 1.5A			200	mV
Load Regulation 2	ΔVold2	250mA ≤ I _o ≤ 750mA			100	mV
Output Voltage 2	Vo2	12.5V ≤ V _{IN} ≤ 25V, 5mA ≤ I _o ≤ 1A	9.5		10.5	V
Current Dissipation	I _{cc}				8.0	mA
Current Dissipation Variation (Line)	ΔI _{cc} ln	12.5V ≤ V _{IN} ≤ 25V			1.0	mA
Current Dissipation Variation (Load)	ΔI _{cc} ld	5mA ≤ I _o ≤ 1A			0.5	mA
Output Noise Voltage	V _{NO}	10Hz ≤ f ≤ 100kHz*		63		μV
Ripple Rejection	R _r	f=120Hz, 13V ≤ V _{IN} ≤ 23V	55	72		dB
Dropout Voltage	V _{drop}	I _o =1A		2.0		V
Output Short Current	I _{os}	V _{IN} =35V		0.75		A
Peak Output Current	I _{op}			2.2		A
Output Voltage at Strobe Mode	Vo(ston)	V _{IN} =35V, V _{st} =5V, I _o =0,*			0.8	V
Current Dissipation at Strobe Mode	I _{cc} (ston)	"			3.0	mA
Strobe Input Current	I _{st}	"			1.0	mA

L780S00 Series

L780S12

Recommended Operating Conditions at Ta=25°C

	unit
Input Voltage Range V_{IN}	15.0 to 27.0 V
Output Current Range I_o	5 to 1000 mA

Operating Characteristics at Tj=25°C, $V_{IN}=19V, I_o=500mA, V_{st}=0V, *Ta=25°C$

		min	typ	max	unit
Output Voltage 1	Vo1	11.5	12.0	12.5	V
Line Regulation 1	ΔV_{oln1} $14.5V \leq V_{IN} \leq 30V$		10	240	mV
Line Regulation 2	ΔV_{oln2} $16V \leq V_{IN} \leq 22V$		3	120	mV
Load Regulation 1	ΔV_{old1} $5mA \leq I_o \leq 1.5A$			240	mV
Load Regulation 2	ΔV_{old2} $250mA \leq I_o \leq 750mA$			120	mV
Output Voltage 2	Vo2 $14.5V \leq V_{IN} \leq 27V, 5mA \leq V_{IN} \leq 1A$	11.4		12.6	V
Current Dissipation	Icc			8.0	mA
Current Dissipation Variation (Line)	ΔI_{ccln} $14.5V \leq V_{IN} \leq 30V$			1.0	mA
Current Dissipation Variation (Load)	ΔI_{ccld} $5mA \leq I_o \leq 1A$			0.5	mA
Output Noise Voltage	V_{NO} $10Hz \leq f \leq 100kHz^*$		75		uV
Ripple Rejection	Rr $f=120Hz, 15V \leq V_{IN} \leq 25V$	55	71		dB
Dropout Voltage	Vdrop $I_o=1A$		2.0		V
Output Short Current	Ios $V_{IN}=35V$		0.75		A
Peak Output Current	Iop		2.2		A
Output Voltage at Strobe Mode	Vo(ston) $V_{IN}=35V, V_{st}=5V, I_o=0, *$			0.8	V
Current Dissipation at Strobe Mode	Icc(ston) "			3.0	mA
Strobe Input Current	Ist "			1.0	mA

L780S15

Recommended Operating Conditions at Ta=25°C

	unit
Input Voltage Range V_{IN}	18.0 to 30.0 V
Output Current Range I_o	5 to 1000 mA

Operating Characteristics at Tj=25°C, $V_{IN}=23V, I_o=500mA, V_{st}=0V, *Ta=25°C$

		min	typ	max	unit
Output Voltage 1	Vo1	14.4	15.0	15.6	V
Line Regulation 1	ΔV_{oln1} $17.5V \leq V_{IN} \leq 30V$		11	300	mV
Line Regulation 2	ΔV_{oln2} $20V \leq V_{IN} \leq 26V$		3	150	mV
Load Regulation 1	ΔV_{old1} $5mA \leq I_o \leq 1.5A$			300	mV
Load Regulation 2	ΔV_{old2} $250mA \leq I_o \leq 750mA$			150	mV
Output Voltage 2	Vo2 $17.5V \leq V_{IN} \leq 30V, 5mA \leq V_{IN} \leq 1A$	14.25		15.75	V
Current Dissipation	Icc			8.0	mA
Current Dissipation Variation (Line)	ΔI_{ccln} $17.5V \leq V_{IN} \leq 30V$			1.0	mA
Current Dissipation Variation (Load)	ΔI_{ccld} $5mA \leq I_o \leq 1A$			0.5	mA
Output Noise Voltage	V_{NO} $10Hz \leq f \leq 100kHz^*$		90		uV
Ripple Rejection	Rr $f=120Hz, 18.5V \leq V_{IN} \leq 28.5V$	54	70		dB
Dropout Voltage	Vdrop $I_o=1A$		2.0		V
Output Short Current	Ios $V_{IN}=35V$		0.75		A
Peak Output Current	Iop		2.2		A
Output Voltage at Strobe Mode	Vo(ston) $V_{IN}=35V, V_{st}=5V, I_o=0, *$			0.8	V
Current Dissipation at Strobe Mode	Icc(ston) "			3.0	mA
Strobe Input Current	Ist "			1.0	mA

L780S00 Series

L780S18

Recommended Operating Conditions at Ta=25°C

			unit
Input Voltage Range	V_{IN}	21.0 to 33.0	V
Output Current Range	I_O	5 to 1000	mA

Operating Characteristics at Tj=25°C, $V_{IN}=27V$, $I_O=500mA$, $V_{st}=0V$, *Ta=25°C

			min	typ	max	unit
Output Voltage 1	V_{o1}		17.3	18.0	18.7	V
Line Regulation 1	ΔV_{oln1}	$21V \leq V_{IN} \leq 33V$		15	360	mV
Line Regulation 2	ΔV_{oln2}	$24V \leq V_{IN} \leq 30V$		5	180	mV
Load Regulation 1	ΔV_{old1}	$5mA \leq I_O \leq 1.5A$			360	mV
Load Regulation 2	ΔV_{old2}	$250mA \leq I_O \leq 750mA$			180	mV
Output Voltage 2	V_{o2}	$21V \leq V_{IN} \leq 33V$, $5mA \leq V_{IN} \leq 1A$	17.1		18.9	V
Current Dissipation	I_{cc}				8.0	mA
Current Dissipation Variation (Line)	ΔI_{ccln}	$21V \leq V_{IN} \leq 33V$			1.0	mA
Current Dissipation Variation (Load)	ΔI_{ccld}	$5mA \leq I_O \leq 1A$			0.5	mA
Output Noise Voltage	V_{NO}	$10Hz \leq f \leq 100kHz^*$		110		uV
Ripple Rejection	R_r	$f=120Hz$, $22V \leq V_{IN} \leq 32V$	53	69		dB
Dropout Voltage	V_{drop}	$I_O=1A$		2.0		V
Output Short Current	I_{os}	$V_{IN}=35V$		0.75		A
Peak Output Current	I_{op}			2.2		A
Output Voltage at Strobe Mode	$V_{o(ston)}$	$V_{IN}=35V, V_{st}=5V$, $I_O=0, *$			0.8	V
Current Dissipation at Strobe Mode	$I_{cc(ston)}$	"			3.0	mA
Strobe Input Current	I_{st}	"			1.0	mA

L780S20

Recommended Operating Conditions at Ta=25°C

			unit
Input Voltage Range	V_{IN}	23.0 to 35.0	V
Output Current Range	I_O	5 to 1000	mA

Operating Characteristics at Tj=25°C, $V_{IN}=29V$, $I_O=500mA$, $V_{st}=0V$, *Ta=25°C

			min	typ	max	unit
Output Voltage 1	V_{o1}		19.2	20.0	20.8	V
Line Regulation 1	ΔV_{oln1}	$23V \leq V_{IN} \leq 35V$		15	400	mV
Line Regulation 2	ΔV_{oln2}	$26V \leq V_{IN} \leq 32V$		5	200	mV
Load Regulation 1	ΔV_{old1}	$5mA \leq I_O \leq 1.5A$			400	mV
Load Regulation 2	ΔV_{old2}	$250mA \leq I_O \leq 750mA$			200	mV
Output Voltage 2	V_{o2}	$24V \leq V_{IN} \leq 35V$, $5mA \leq V_{IN} \leq 1A$	19.0		21.0	V
Current Dissipation	I_{cc}				8.0	mA
Current Dissipation Variation (Line)	ΔI_{ccln}	$23V \leq V_{IN} \leq 35V$			1.0	mA
Current Dissipation Variation (Load)	ΔI_{ccld}	$5mA \leq I_O \leq 1A$			0.5	mA
Output Noise Voltage	V_{NO}	$10Hz \leq f \leq 100kHz^*$		110		uV
Ripple Rejection	R_r	$f=120Hz$, $24V \leq V_{IN} \leq 34V$	53	67		dB
Dropout Voltage	V_{drop}	$I_O=1A$		2.0		V
Output Short Current	I_{os}	$V_{IN}=35V$		0.75		A
Peak Output Current	I_{op}			2.2		A
Output Voltage at Strobe Mode	$V_{o(ston)}$	$V_{IN}=35V, V_{st}=5V$, $I_O=0, *$			0.8	V
Current Dissipation at Strobe Mode	$I_{cc(ston)}$	"			3.0	mA
Strobe Input Current	I_{st}	"			1.0	mA

L780500 Series

L780S24

Recommended Operating Conditions at $T_a=25^\circ\text{C}$

Parameter	Symbol	Value	unit
Input Voltage Range	V_{IN}	27.0 to 35.0	V
Output Current Range	I_o	5 to 1000	mA

Operating Characteristics at $T_j=25^\circ\text{C}, V_{IN}=33\text{V}, I_o=500\text{mA}, V_{st}=0\text{V}, *T_a=25^\circ\text{C}$

Parameter	Symbol	Conditions	min	typ	max	unit
Output Voltage 1	V_{o1}		23.0	24.0	25.0	V
Line Regulation 1	ΔV_{oln1}	$27\text{V} \leq V_{IN} \leq 35\text{V}$		18	480	mV
Line Regulation 2	ΔV_{oln2}	$30\text{V} \leq V_{IN} \leq 35\text{V}$		6	240	mV
Load Regulation 1	ΔV_{old1}	$5\text{mA} \leq I_o \leq 1.5\text{A}$			480	mV
Load Regulation 2	ΔV_{old2}	$250\text{mA} \leq I_o \leq 750\text{mA}$			240	mV
Output Voltage 2	V_{o2}	$27\text{V} \leq V_{IN} \leq 35\text{V},$ $5\text{mA} \leq I_o \leq 1\text{A}$	22.8		25.2	V
Current Dissipation	I_{cc}				8.0	mA
Current Dissipation Variation (Line)	ΔI_{cc1n}	$27\text{V} \leq V_{IN} \leq 35\text{V}$			1.0	mA
Current Dissipation Variation (Load)	ΔI_{ccld}	$5\text{mA} \leq I_o \leq 1\text{A}$			0.5	mA
Output Noise Voltage	V_{NO}	$10\text{Hz} \leq f \leq 100\text{kHz}^*$		180		μV
Ripple Rejection	R_r	$f=120\text{Hz},$ $28\text{V} \leq V_{IN} \leq 34\text{V}$	50	66		dB
Dropout Voltage	V_{drop}	$I_o=1\text{A}$		2.0		V
Output Short Current	I_{os}	$V_{IN}=35\text{V}$		0.75		A
Peak Output Current	I_{op}			2.2		A
Output Voltage at Strobe Mode	$V_{o(ston)}$	$V_{IN}=35\text{V}, V_{st}=5\text{V},$ $I_o=0, *$			0.8	V
Current Dissipation at Strobe Mode	$I_{cc(ston)}$	"			3.0	mA
Strobe Input Current	I_{st}	"			1.0	mA

Equivalent Circuit Block Diagram

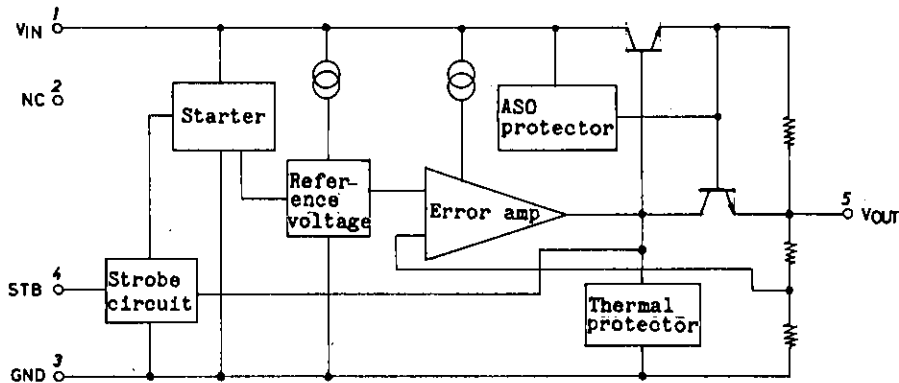

L780S00 Series

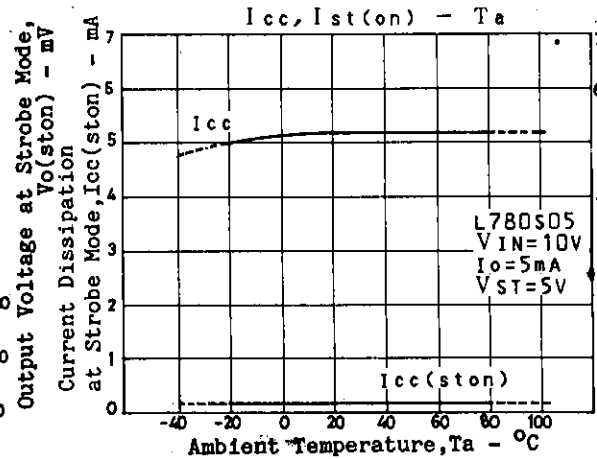
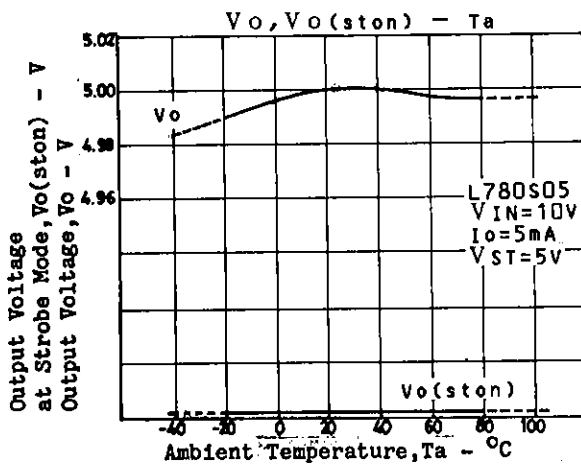
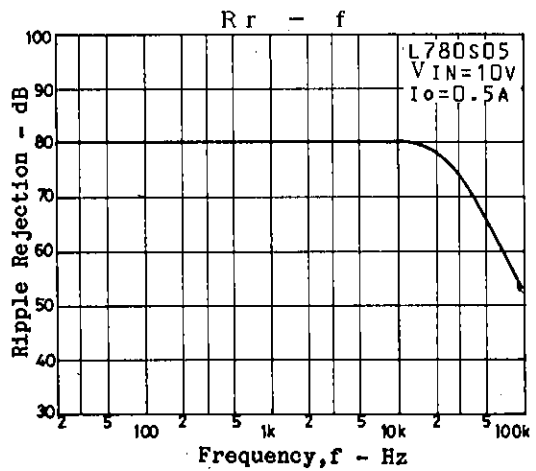
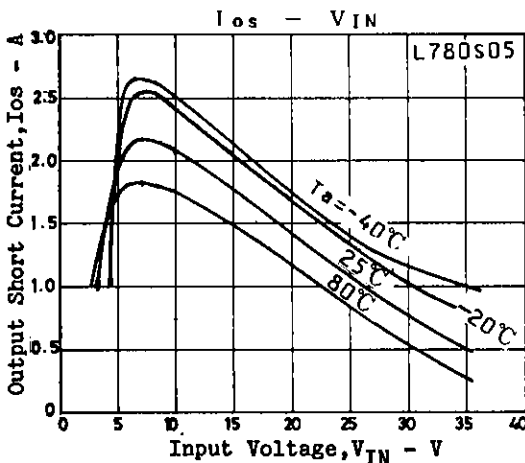
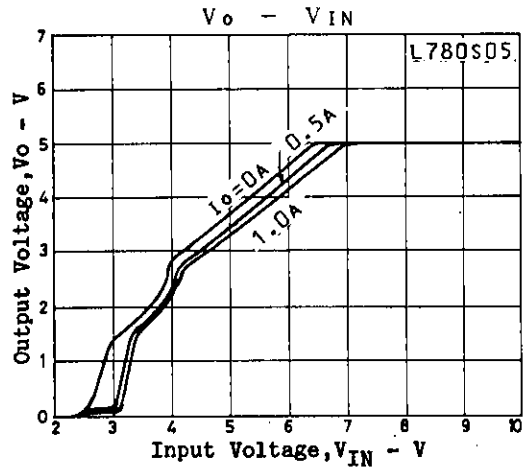
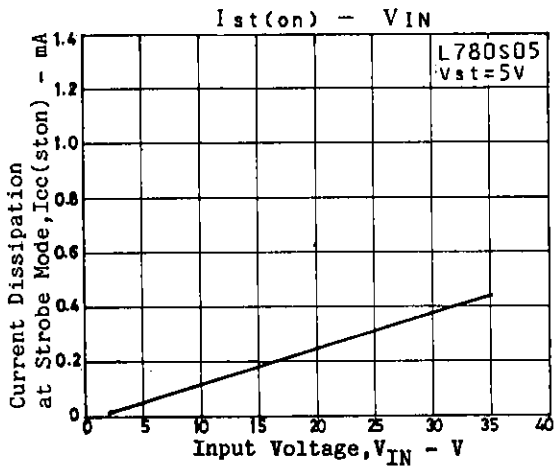
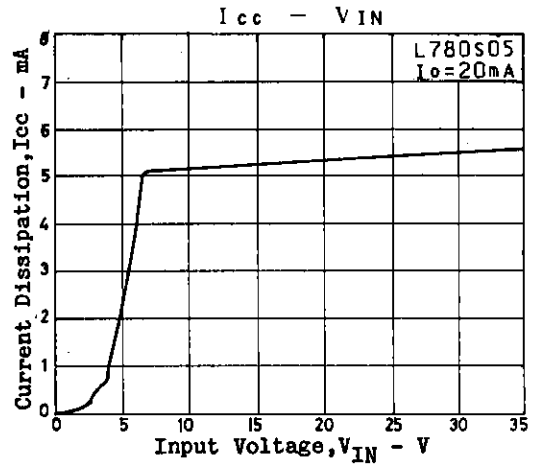
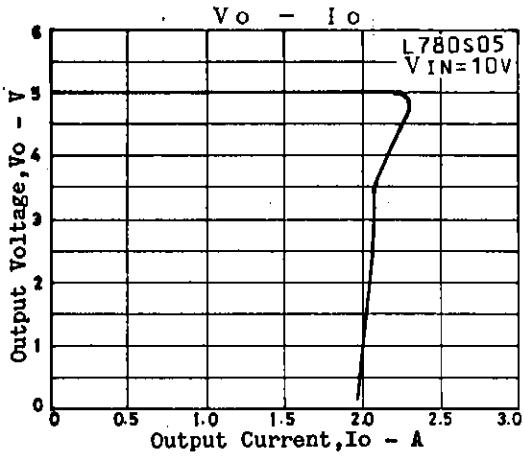

L780S00 Series

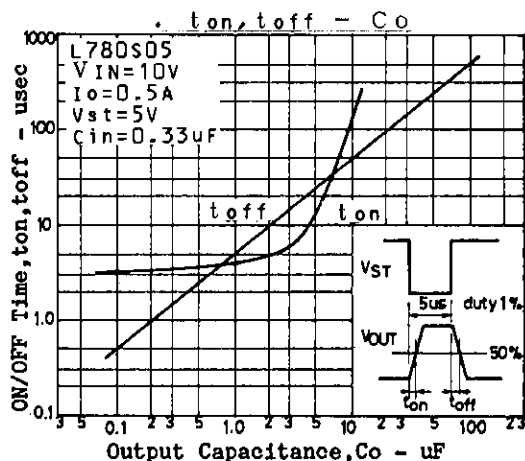
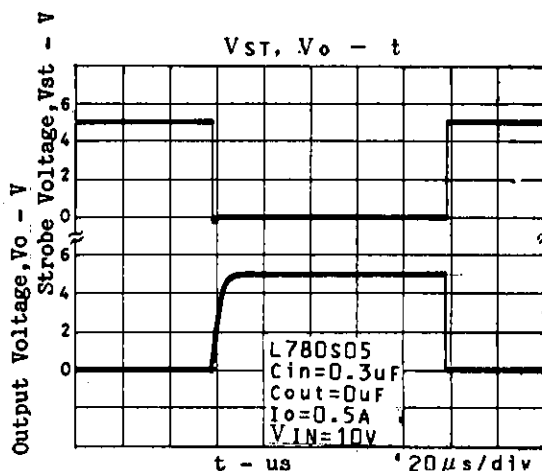
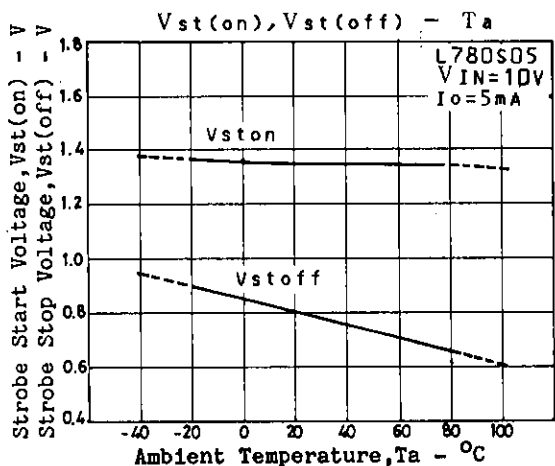

■ No products described or contained herein are intended for use in surgical implants, life-support systems, aerospace equipment, nuclear power control systems, vehicles, disaster/crime-prevention equipment and the like, the failure of which may directly or indirectly cause injury, death or property loss.

■ Anyone purchasing any products described or contained herein for an above-mentioned use shall:

- ① Accept full responsibility and indemnify and defend SANYO ELECTRIC CO., LTD., its affiliates, subsidiaries and distributors and all their officers and employees, jointly and severally, against any and all claims and litigation and all damages, cost and expenses associated with such use;
- ② Not impose any responsibility for any fault or negligence which may be cited in any such claim or litigation on SANYO ELECTRIC CO., LTD., its affiliates, subsidiaries and distributors or any of their officers and employees jointly or severally.

■ Information (including circuit diagrams and circuit parameters) herein is for example only; it is not guaranteed for volume production. SANYO believes information herein is accurate and reliable, but no guarantees are made or implied regarding its use or any infringements of intellectual property rights or other rights of third parties.