

SANYO

No.2173B

L5431**High-Precision Variable Shunt
Voltage Regulator**

The L5431 is a high-precision variable shunt voltage regulator IC whose output voltage can be set to a value from approximately 2.5V to 36V by using external resistors. Because of low output resistance and fast pulse response, the L5431 can be most suitably used as high-precision voltage reference, high-speed comparator, or zener diode.

Features

- (1) Excellent temperature characteristic of V_{ref} : 50ppm/ $^{\circ}C$ (typ)
- (2) Output voltage settable: Approximately 2.5V to 36V
- (3) Output flow-in current range: 1mA to 100mA
- (4) Low dynamic resistance: 0.15ohm(typ)
- (5) Fast response
- (6) Low output noise voltage
- (7) Small-sized TO-92

Maximum Ratings at $T_a=25^{\circ}C$

			unit
Maximum Voltage Applied across Cathode and Anode	V_{KA} max	Referenced to anode	37 V
Cathode Current	I_K max		-100 to +150 mA
Reference Voltage Pin Input Current	I_{ref}		-0.05 to +10 mA
Allowable Power Dissipation	P_d max	$T_a \leq 25^{\circ}C$	750 mW
Operating Temperature	T_{opr}		-20 to +85 $^{\circ}C$
Storage Temperature	T_{stg}		-65 to +150 $^{\circ}C$

Recommended Operating Conditions at $T_a=25^{\circ}C$

			unit
Voltage Applied across Cathode and Anode	V_{KA}		V_{ref} to 36 V
Cathode Current	I_K	Stabilized state	1 to 100 mA

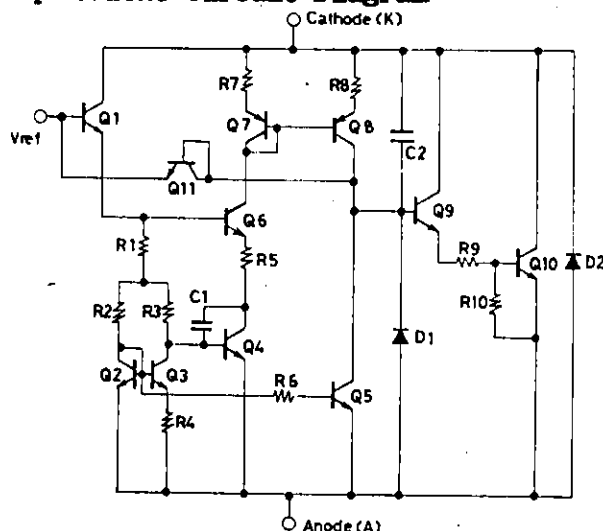
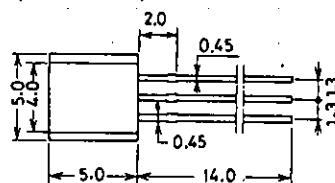
Equivalent Circuit Diagram**Package Dimensions 3101
(unit: mm)**

JEDEC: TO-92
EIAJ: SC-43
SANYO: NP

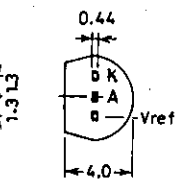

K: Cathode
A: Anode
 V_{ref} : Reference voltage

SANYO Electric Co., Ltd. Semiconductor Business Headquarters
TOKYO OFFICE Tokyo Bldg., 1-10, 1 Chome, Ueno, Taito-ku, TOKYO, 110 JAPAN

O2894HK/8220TA/7237TA, TS No.2173-1/3

Electrical Characteristics at Ta=25°C

			min	typ	max	unit	Test Circuit
Reference Voltage	Vref	V _{KA} =Vref, I _K =10mA	2440	2495	2550	mV	Fig.1
Reference Voltage Change with Temperature (Note1)	ΔVref(Ta)	V _{KA} =Vref, I _K =10mA, Ta=0 to +70°C		8	17	mV	Fig.1
Vref Change Ratio to V _{KA}	$\frac{\Delta V_{ref}}{\Delta V_{KA}}$	I _K =10mA, ΔV _{KA} =10V to Vref I _K =10mA, ΔV _{KA} =36V to 10V		-1.4	-2.7	mV/V	Fig.2
Reference Voltage Pin Input Current Change with Temperature (Note1)	ΔIref(Ta)	I _K =10mA, R1=10kohms R2=∞, Ta=0 to +70°C		2	4	μA	Fig.2
Minimum Cathode Current	I _{KMIN}	V _{KA} =Vref, regulation available		0.4	1	mA	Fig.1
OFF-State Cathode Current	I _{Koff}	V _{KA} =36V, Vref=0		0.1	1	μA	Fig.3
Dynamic Resistance (Note2)	Z _{KA}	V _{KA} =Vref, f ≤ 1kHz, I _K =1 to 100mA		0.15	0.5	ohm	Fig.1

Input Voltage

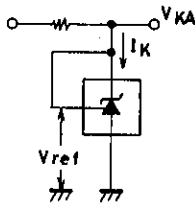

Fig.1

Input Voltage

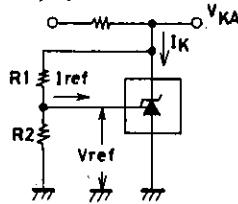

Fig.2

Input Voltage

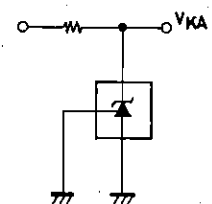
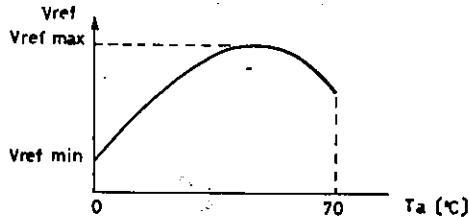

Fig.3

Note1: ΔVref(Ta) is defined by using Vref max and Vref min as follows:

$$\Delta V_{ref}(T_a) = V_{ref \max} - V_{ref \min}$$



Note2: The dynamic resistance is defined as follows:

$$|\Delta Z_{KA}| = \frac{\Delta V_{KA}}{\Delta I_K}$$

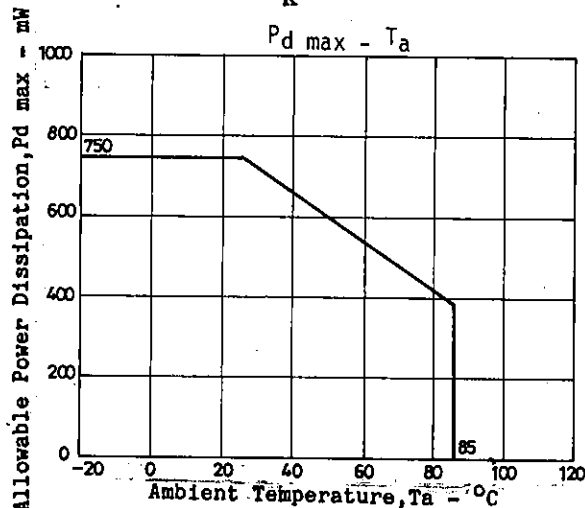

- No products described or contained herein are intended for use in surgical implants, life-support systems, aerospace equipment, nuclear power control systems, vehicles, disaster/crime-prevention equipment and the like, the failure of which may directly or indirectly cause injury, death or property loss.
- Anyone purchasing any products described or contained herein for an above-mentioned use shall:
 - ① Accept full responsibility and indemnify and defend SANYO ELECTRIC CO., LTD., its affiliates, subsidiaries and distributors and all their officers and employees, jointly and severally, against any and all claims and litigation and all damages, cost and expenses associated with such use;
 - ② Not impose any responsibility for any fault or negligence which may be cited in any such claim or litigation on SANYO ELECTRIC CO., LTD., its affiliates, subsidiaries and distributors or any of their officers and employees jointly or severally.
- Information (including circuit diagrams and circuit parameters) herein is for example only; it is not guaranteed for volume production. SANYO believes information herein is accurate and reliable, but no guarantees are made or implied regarding its use or any infringements of intellectual property rights or other rights of third parties.