



# FX504

NPN Epitaxial Planar Silicon Transistor

## High-Current Switching Applications

### Features

- Composite type with 2 NPN transistors contained in one package, facilitating high-density mounting.
- The FX504 houses two chips, each being equivalent to the 2SD1802, in one package.
- Matched pair characteristics.

### Package Dimensions

unit:mm  
2118

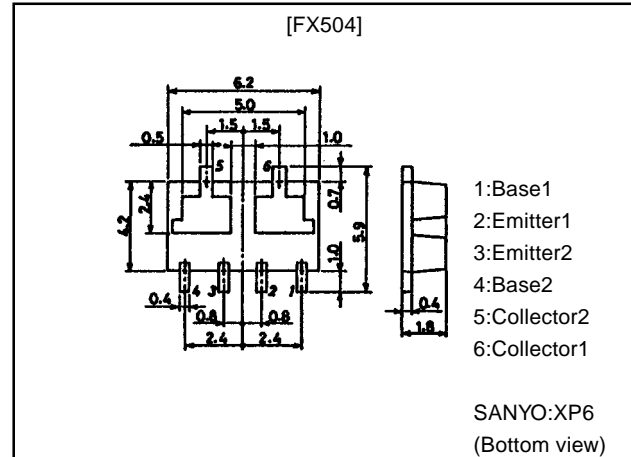

### Switching Time Test Circuit

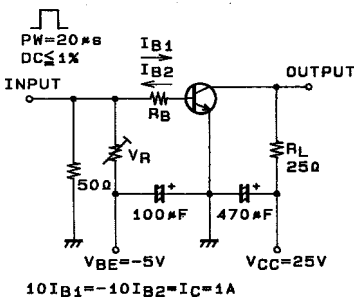

### Electrical Connection

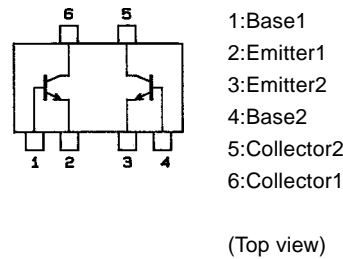

### Specifications

#### Absolute Maximum Ratings at $T_a = 25^\circ C$

Parameter	Symbol	Conditions	Ratings	Unit
Collector-to-Base Voltage	$V_{CB0}$		60	V
Collector-to-Emitter Voltage	$V_{CE0}$		50	V
Emitter-to-Base Voltage	$V_{EB0}$		6	V
Collector Current	$I_C$		3	A
Collector Current (Pulse)	$I_{CP}$		6	A
Base Current	$I_B$		600	mA
Collector Dissipation	$P_C$	Mounted on ceramic board (750mm <sup>2</sup> ×0.8mm) 1 unit	1.5	W
Total Dissipation	$P_T$	Mounted on ceramic board (750mm <sup>2</sup> ×0.8mm)	2	W
Junction Temperature	$T_J$		150	°C
Storage Temperature	$T_{stg}$		-55 to +150	°C

· Marking:504

Continued on next page.

## FX504

Continued from preceding page.

### Electrical Characteristics at $T_a = 25^\circ\text{C}$

Parameter	Symbol	Conditions	Ratings			Unit
			min	typ	max	
Collector Cutoff Current	$I_{CBO}$	$V_{CB}=40\text{V}, I_E=0$			1	$\mu\text{A}$
Emitter Cutoff Current	$I_{EBO}$	$V_{EB}=4\text{V}, I_C=0$			1	$\mu\text{A}$
DC Current Gain	$h_{FE1}$	$V_{CE}=2\text{V}, I_C=100\text{mA}$	140		400	
	$h_{FE2}$	$V_{CE}=2\text{V}, I_C=-3\text{A}$	35			
DC Current Gain Ratio	$h_{FE}(\text{small/large})$	$V_{CE}=2\text{V}, I_C=100\text{mA}$	0.8			
Gain-Bandwidth Product	$f_T$	$V_{CE}=10\text{V}, I_C=100\text{mA}$		170		MHz
Output Capacitance	Cob	$V_{CB}=10\text{V}, f=1\text{MHz}$		25		pF
C-E Saturation Voltage	$V_{CE}(\text{sat})$	$I_C=2\text{A}, I_B=100\text{mA}$		190	500	mV
B-E Saturation Voltage	$V_{BE}(\text{sat})$	$I_C=2\text{A}, I_B=100\text{mA}$		0.94	1.2	V
C-B Breakdown Voltage	$V_{(BR)CBO}$	$I_C=10\mu\text{A}, I_E=0$	60			V
C-E Breakdown Voltage	$V_{(BR)CEO}$	$I_C=1\text{mA}, R_{BE}=\infty$	50			V
E-B Breakdown Voltage	$V_{(BR)EBO}$	$I_E=10\mu\text{A}, I_C=0$	6			V
Turn-ON Time	$t_{on}$	See sepcified Test Circuit		70		ns
Storage Time	tstg	See sepcified Test Circuit		650		ns
Fall Time	$t_f$	See sepcified Test Circuit		35		ns

# FX504

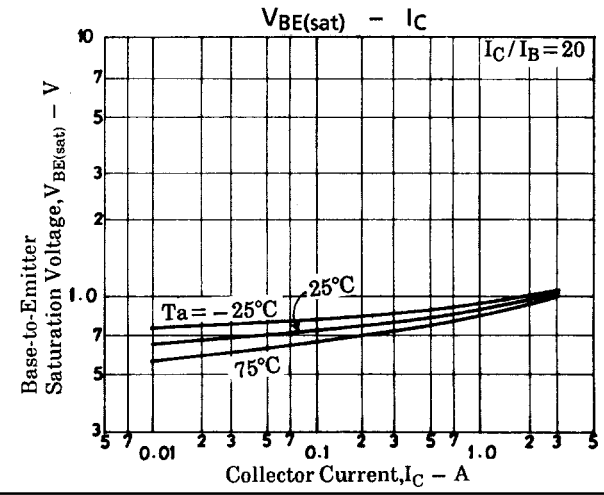
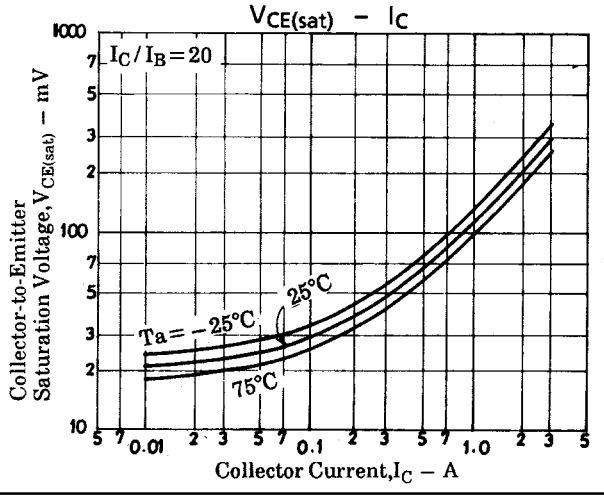
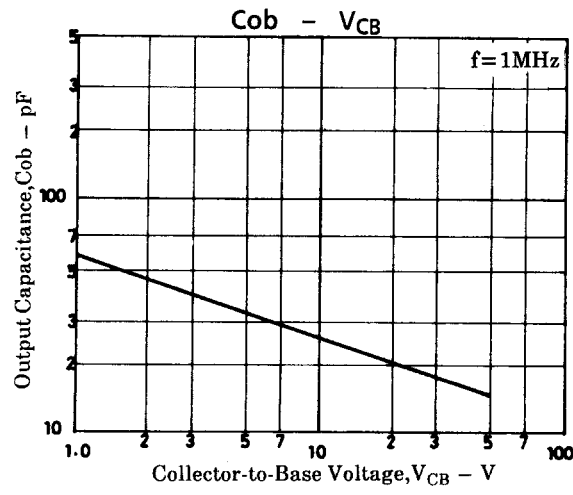
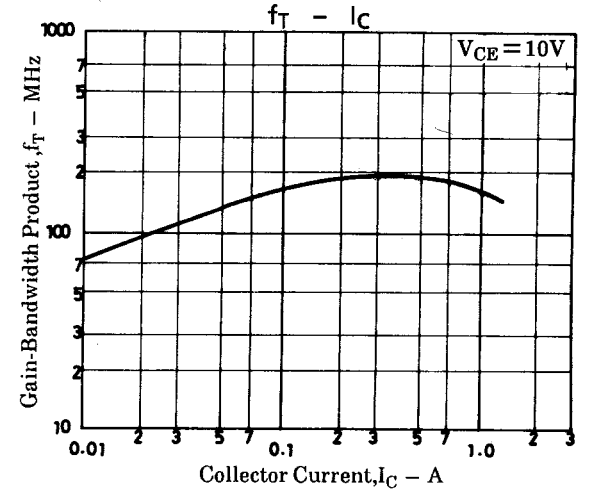
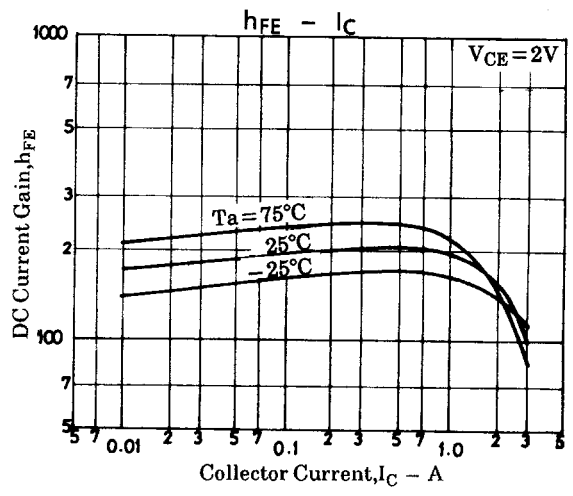
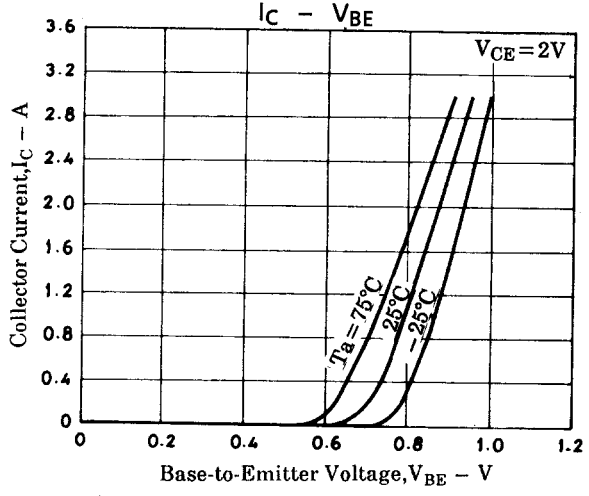
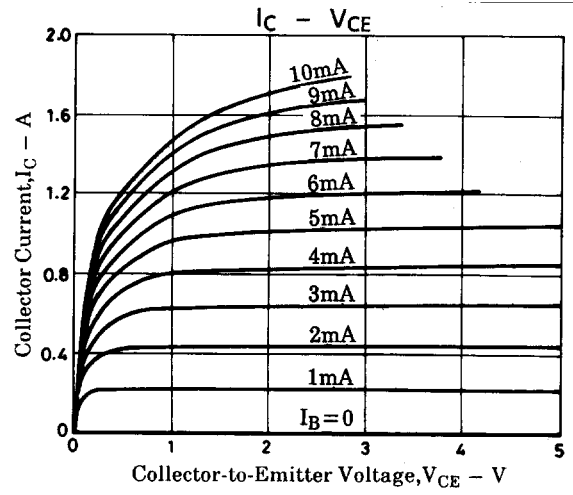
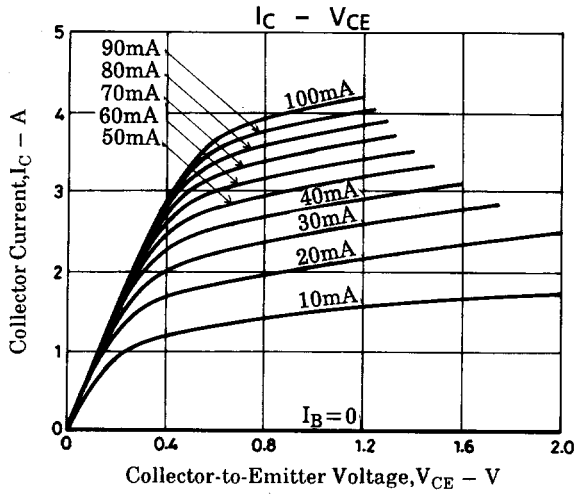

# FX504

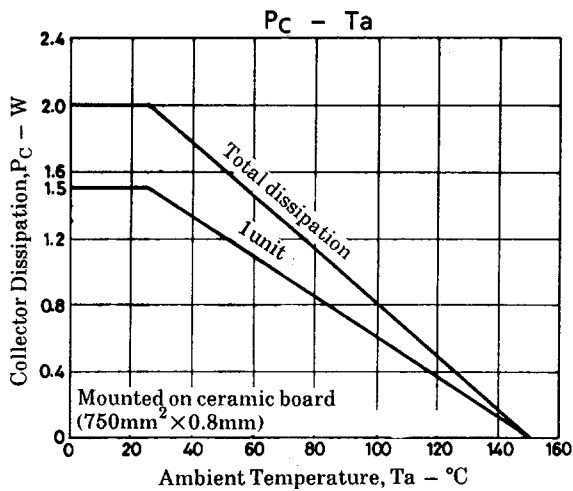
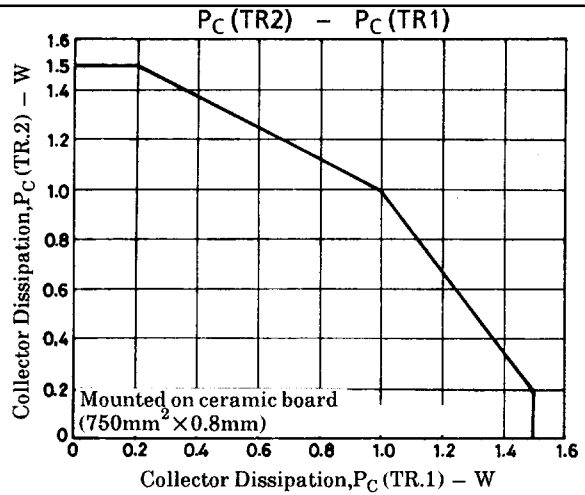
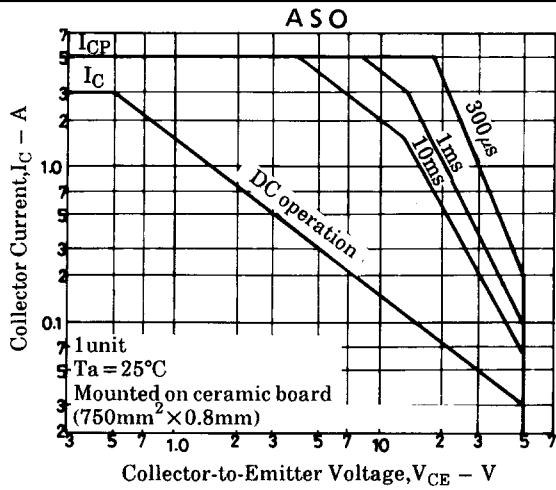

- No products described or contained herein are intended for use in surgical implants, life-support systems, aerospace equipment, nuclear power control systems, vehicles, disaster/crime-prevention equipment and the like, the failure of which may directly or indirectly cause injury, death or property loss.
- Anyone purchasing any products described or contained herein for an above-mentioned use shall:
  - ① Accept full responsibility and indemnify and defend SANYO ELECTRIC CO., LTD., its affiliates, subsidiaries and distributors and all their officers and employees, jointly and severally, against any and all claims and litigation and all damages, cost and expenses associated with such use:
  - ② Not impose any responsibility for any fault or negligence which may be cited in any such claim or litigation on SANYO ELECTRIC CO., LTD., its affiliates, subsidiaries and distributors or any of their officers and employees jointly or severally.
- Information (including circuit diagrams and circuit parameters) herein is for example only; it is not guaranteed for volume production. SANYO believes information herein is accurate and reliable, but no guarantees are made or implied regarding its use or any infringements of intellectual property rights or other rights of third parties.

This catalog provides information as of May, 1998. Specifications and information herein are subject to change without notice.