

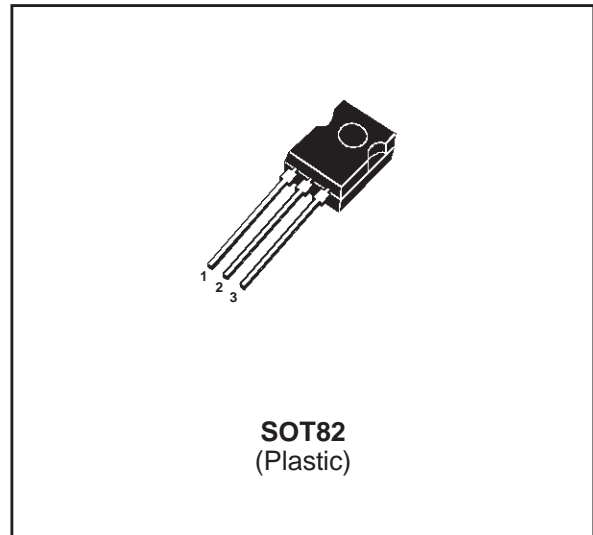

FEATURES

- SPACE SAVING : MONOLITHIC FIRE LIGHTER FUNCTION INTEGRATION
- DEDICATED THYRISTOR STRUCTURE FOR CAPACITANCE DISCHARGE IGNITION OPERATION
- HIGH PULSE CURRENT CAPABILITY
150A @ $t_p = 10\mu s$



DESCRIPTION

- The FLC01 is a high performance planar difused technology adapted to high temperature and rugged environmental conditions.
- It has been developed especially for capacitance discharge operation. The main applications are gas lighter or ignitor such as :
cookers / gas boilers / gas hobs...

Th : Thyristor for switching operation.

Z : Zener diode to set the threshold voltage.

D : Diode for reverse conduction.

R : 2 k Ω resistor.

FUNCTIONAL DIAGRAM

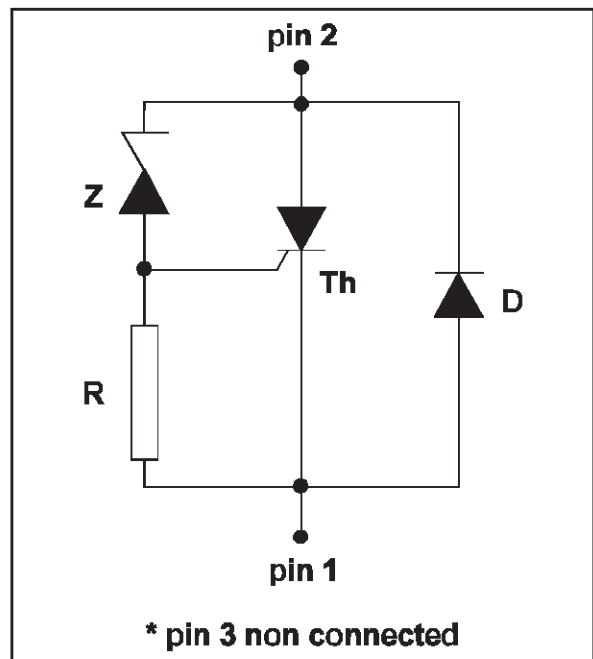

FLC01-200D

ABSOLUTE RATINGS (limiting values) : $-30^{\circ}\text{C} < T_{\text{amb}} < 120^{\circ}\text{C}$

Symbol	Parameter	Value	Unit
I_{TRM}	Repetitive surge peak on state current for thyristor	150	A
I_{FRM}	Repetitive surge peak on state current for diode		
di/dt	Critical rate of rise time on state current	120	A/ μs
T_{stg} T_{j}	Storage junction temperature range Maximum junction temperature	- 40 to + 150 + 125	$^{\circ}\text{C}$
T_{oper}	Operating temperature range	-30 + 120	$^{\circ}\text{C}$
T_{L}	Maximum lead temperature for soldering during 10s	260	$^{\circ}\text{C}$

Note 1 : Test current waveform

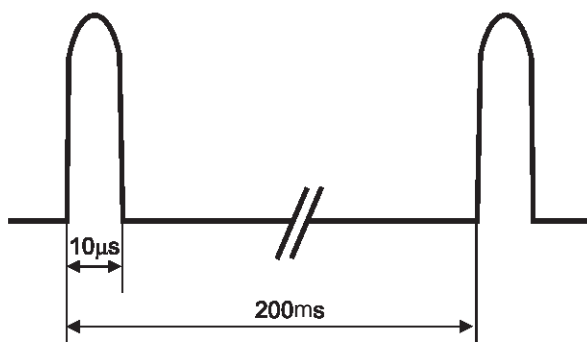

THERMAL RESISTANCE

Symbol	Parameter	Value	Unit
$R_{\text{th(j-a)}}$	Thermal resistance junction to ambient	100	$^{\circ}\text{C}/\text{W}$

ORDERING INFORMATION

FLC	01	-	200	D
FIRE LIGHTER CIRCUIT				PACKAGED : SOT82
				$V_{\text{RM}} 200 = 200\text{ V}$
CIRCUIT NUMBER : 01 = scr + diode + zener + resistance (pin 3 not connected)				

ELECTRICAL CHARACTERISTICS

Symbol	Parameters
V_{RM}	Stand-off voltage
V_{BO}	Breakover voltage
V_T	On-state voltage
V_F	Diode voltage drop
I_{BO}	Breakover current
I_{RM}	Leakage current
α_T	Thermal coefficient for V_{BO}

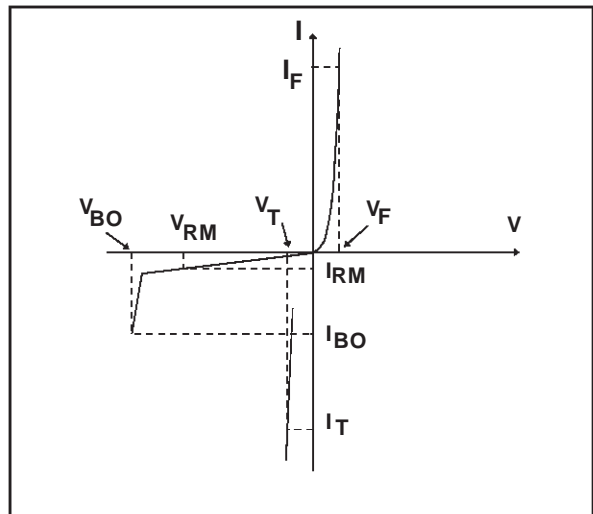

DIODE (D) PARAMETER

Symbol	Test Conditions				Value	Unit
V_F	$I_F = 2A$	$t_p \leq 1\text{ ms}$	$T_j = 25^\circ\text{C}$	MAX	1.7	V

THYRISTOR (Th) and ZENER (Z) PARAMETERS

Symbol	Test conditions		Min	Typ	Max	Unit
I_{RM}	$V_{RM} = 200\text{ V}$	$T_j = 25^\circ\text{C}$			10	μA
		$T_j = 125^\circ\text{C}$			100	μA
V_{BO}	at I_{BO}	$T_j = 25^\circ\text{C}$	200	225	250	V
I_{BO}	at V_{BO}	$T_j = 25^\circ\text{C}$			0.5	mA
V_T	$I_T = 2A$ $t_p \leq 1\text{ms}$	$T_j = 25^\circ\text{C}$			1.7	V
α_T				0.3		$\text{V}/^\circ\text{C}$

Fig.1 : Relative variation of breakover current (I_{BO}) versus junction temperature

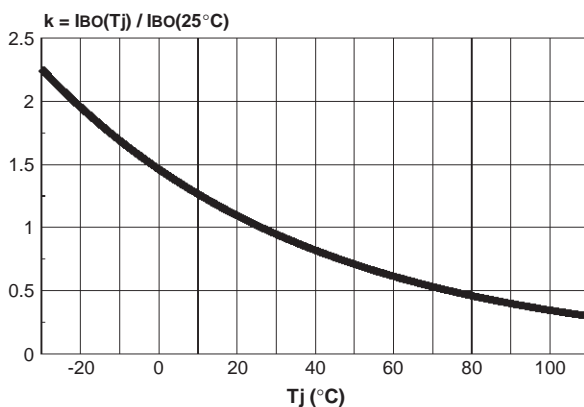

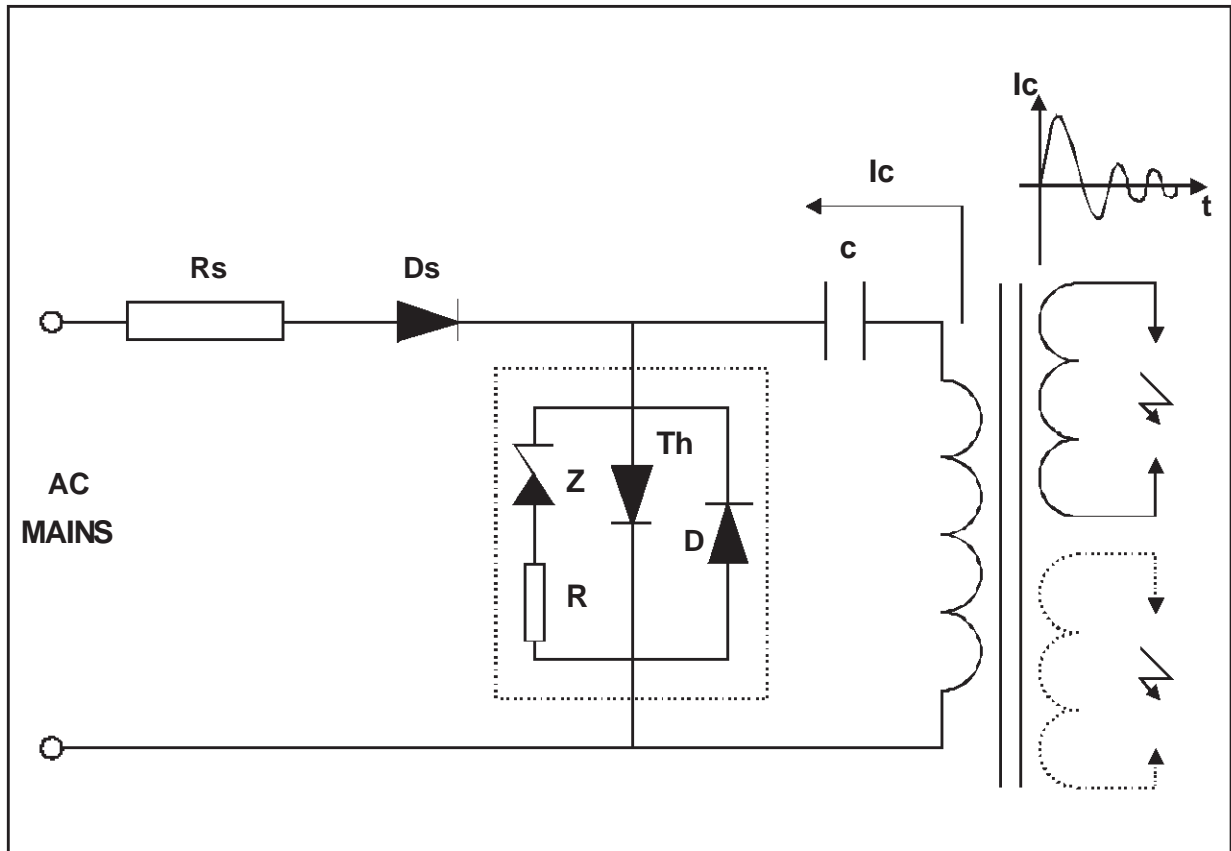

The applications of the lighter using the capacitance discharge topology operate in 2 phases :

PHASE 1

The energy coming from the mains is stored into the capacitor C. For that, the AC voltage is rectified by the diode Ds.

PHASE 2

At the end of the phase 1, the voltage across the capacitor C reaches the avalanche threshold of the zener. Then a current flows through the gate of the thyristor Th which fires.

The firing of the thyristor causes an alternating current to flow through the capacitor C.

The positive parts of this current flow through C, Th and the primary of the HV transformer.

The negative parts of the current flow through C, D and the primary of the HV transformer.

RS RESISTOR CALCULATION

The Rs resistor allows, in addition with the capacitor C, to adjust the spark frequency and to limitate the current from the mains. Its value shall allow the thyristor Th to fire even in the worst case. In this borderline case the system must fire with the lower RMS mains voltage value while the breakdown voltage and current of the FLC are at the maximum.

The maximum Rs value is equal to :

$$R_{smax} = \frac{(V_{AC \text{ min.}} \cdot \sqrt{2}) - [V_{BO \text{ max.}} \cdot (1 + \alpha \cdot T \cdot (T_{amb} - 25))]}{k \cdot I_{BO}^*}$$

* : see fig 1

Fig. 2 : Spark frequency versus Rs and C

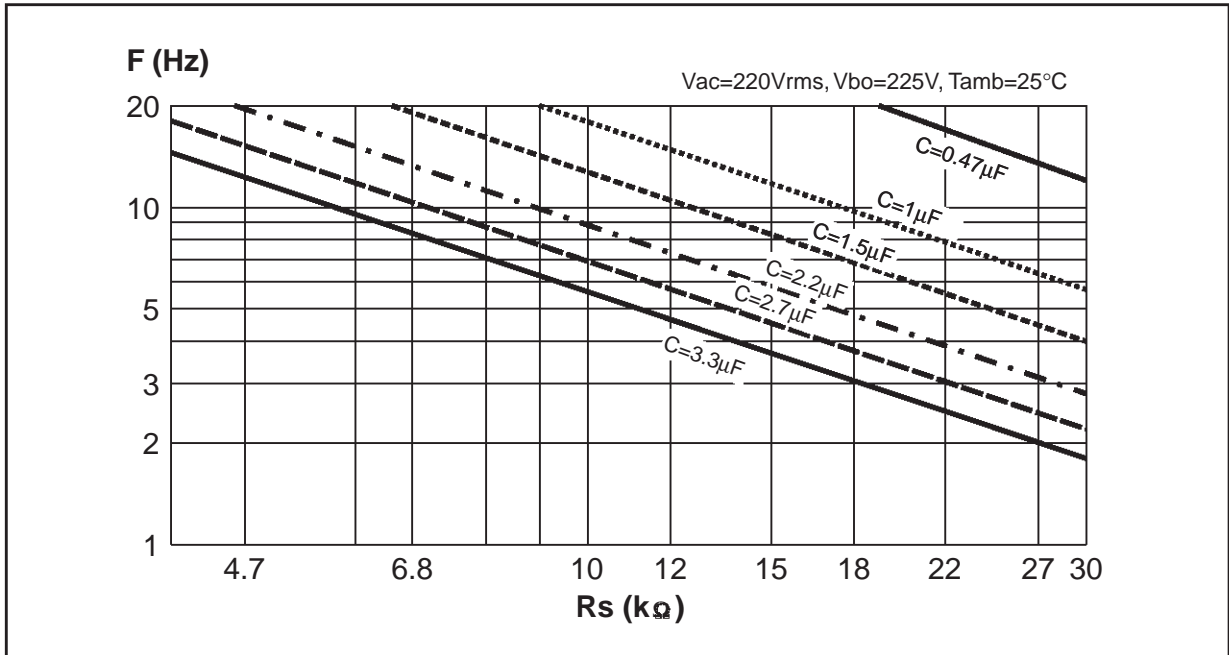

The couple Rs/C can be chosen with the previous curve. Keep in mind the Rs maximum limit for which the system would not work when the AC

mains is minimum. The next curve shows the behavior with Rs=15kΩ and C=1μF.

Fig. 3 : Voltage across the capacitance with Rs = 15kΩ, C = 1μF and VBO = 225V.

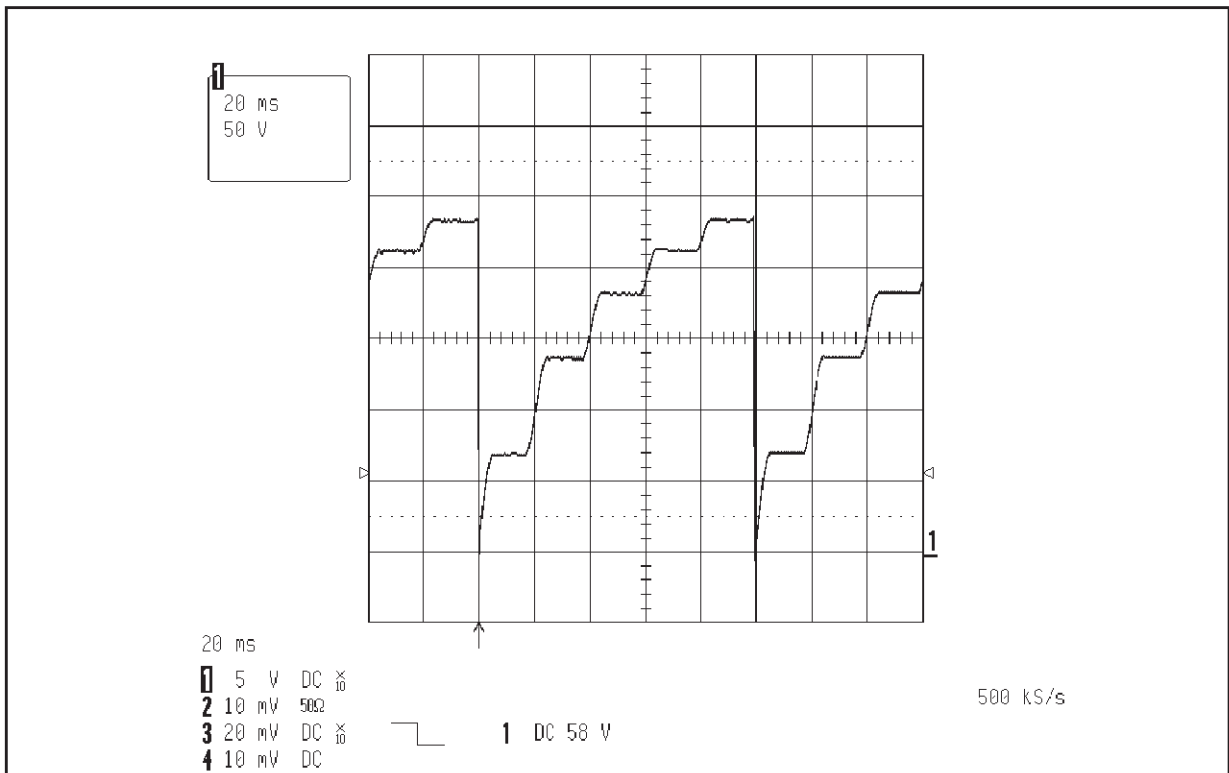

PEAK CURRENT LIMIT

This component is designed to withstand $I_{TRM} = 150A$ for a pulse duration of $10\mu s$ for an

ambient temperature of $120^{\circ}C$ in repetitive surge. The curve of peak current versus the pulse duration allows us to verify if the application is within the FLC operating limit.

Fig. 4 : Peak current limit

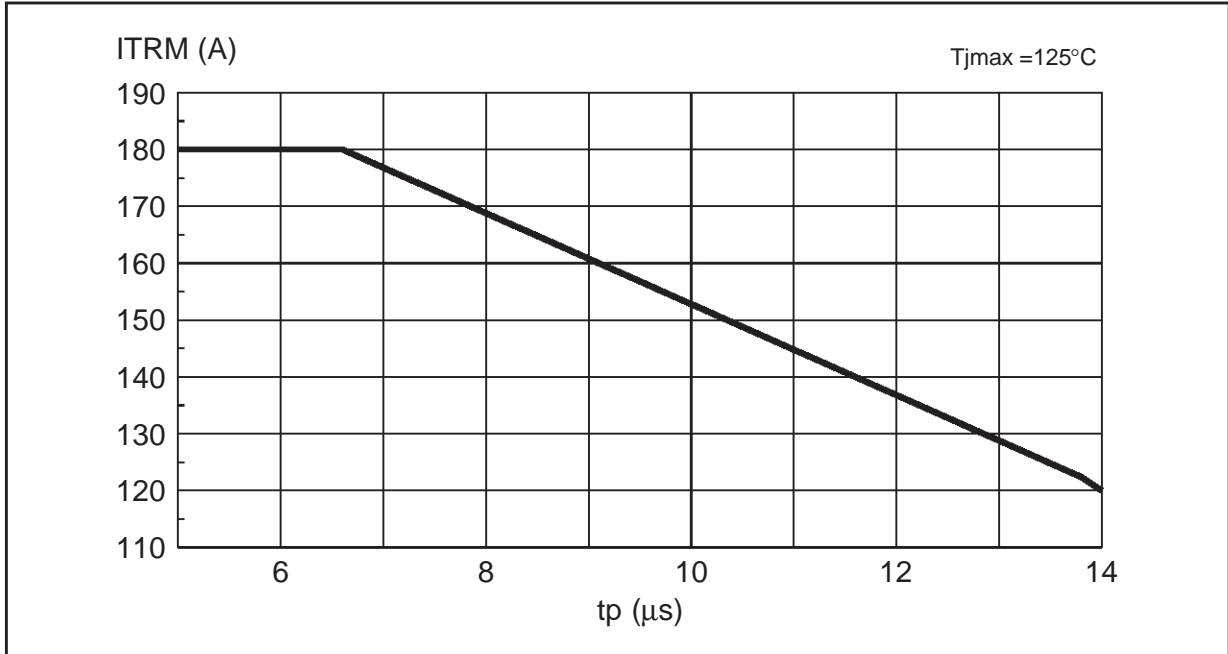

POWER LOSSES (For $10\mu s$, see note 1)

To evaluate the power losses, please use the following equations:

For the thyristor : $P = 1.18 \times I_{T(AV)} + 0.035 I_{T(RMS)}^2$

For the diode : $P = 0.67 \times I_{F(AV)} + 0.106 I_{F(RMS)}^2$

PACKAGE MECHANICAL DATA
SOT82 (Plastic)

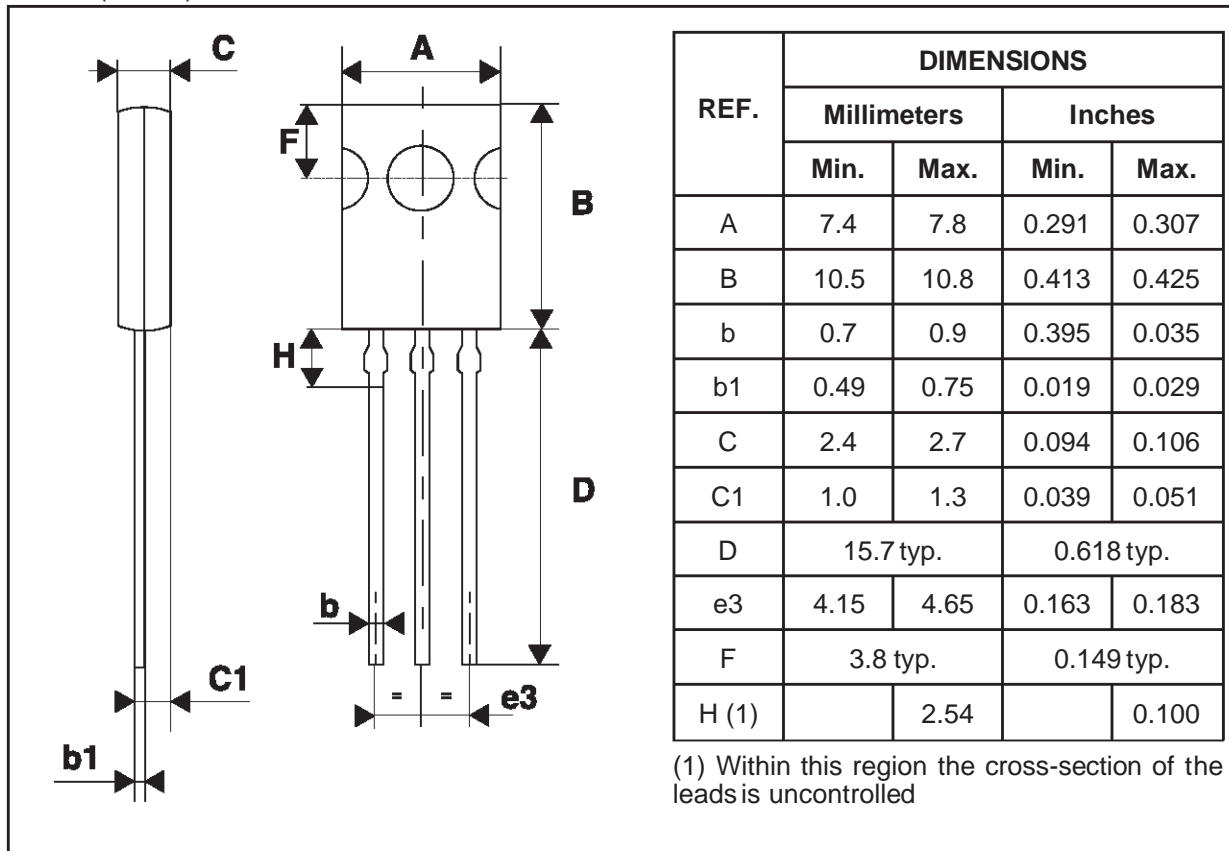

- **Marking** : type number
- **Weight** : 0.72 g.

Information furnished is believed to be accurate and reliable. However, STMicroelectronics assumes no responsibility for the consequences of use of such information nor for any infringement of patents or other rights of third parties which may result from its use. No license is granted by implication or otherwise under any patent or patent rights of STMicroelectronics. Specifications mentioned in this publication are subject to change without notice. This publication supersedes and replaces all information previously supplied. STMicroelectronics products are not authorized for use as critical components in life support devices or systems without express written approval of STMicroelectronics.

The ST logo is a registered trademark of STMicroelectronics

© 1998 STMicroelectronics - Printed in Italy - All rights reserved.

STMicroelectronics GROUP OF COMPANIES

Australia - Brazil - Canada - China - France - Germany - Italy - Japan - Korea - Malaysia - Malta - Mexico - Morocco - The Netherlands - Singapore - Spain - Sweden - Switzerland - Taiwan - Thailand - United Kingdom - U.S.A.

<http://www.st.com>