

	No.1879B	<h1 style="margin: 0;">DTM8-N</h1> <p style="margin: 0;">Silicon Planar Type</p> <h2 style="margin: 0;">8A Bidirectional Thyristor</h2>
--	----------	---

Features

- Insulation type
- Peak OFF-state voltage : 200 to 600V
- RMS ON-state current : 8A
- TO-220 package

Absolute Maximum Ratings at Ta = 25°C

		CDTM 8C-N	DTM 8E-N	DTM 8G-N	unit
Repetitive Peak OFF-State Voltage	V _{DRM}	200	400	600	V
RMS ON-State Current	I _{T(RMS)}	→	→	8	A
Surge ON-State Current	I _{TSM}	→	→	80	A
Amperes Squared-Seconds	i ² t-dt	→	→	32	A ² S
Peak Gate Power Dissipation	P _{GM}	→	→	5	W
Average Gate Power Dissipation	P _{G(AV)}	→	→	0.5	W
Peak Gate Current	I _{GM}	→	→	±2	A
Peak Gate Voltage	V _{GM}	→	→	±10	V
Junction Temperature	T _j	→	→	125	°C
Storage Temperature	T _{stg}	→	-40 to +125		°C
Weight		→	→	2.1	g

T_c = 83°C, single-phase full-wave Peak 1 cycle, 50Hz
1ms ≤ t ≤ 10ms
f ≥ 50Hz, duty ≤ 10%

Electrical Characteristics at Ta = 25°C

			min	typ	max	unit
Repetitive Peak OFF-State Current	I _{DRM}	T _j = 125°C, V _D = V _{DRM}			2	mA
Peak ON-State Voltage	V _{TM}	I _{TM} = 12A			1.5	V
Critical Rate of Rise of OFF-State Voltage	(dv/dt) _c	T _j = 125°C, V _D = 200V(C), 400V(E to G)	10			V/μs
Holding Current	I _H	R _L = 100Ω			50	mA
Gate Trigger Current※ (I)	I _{GT}	V _D = 12V, R _L = 20Ω			30	mA
	I _{GT}	V _D = 12V, R _L = 20Ω			30	mA
	I _{GT}	V _D = 12V, R _L = 20Ω			50	mA
	I _{GT}	V _D = 12V, R _L = 20Ω			30	mA
Gate Trigger Voltage※ (I)	V _{GT}	V _D = 12V, R _L = 20Ω			2	V
	V _{GT}	V _D = 12V, R _L = 20Ω			2	V
	V _{GT}	V _D = 12V, R _L = 20Ω			2	V
	V _{GT}	V _D = 12V, R _L = 20Ω			2	V
Gate Nontrigger Voltage	V _{GD}	T _c = 125°C, V _D = V _{DRM}	0.2			V
Thermal Resistance	R _{th(j-c)}	Between junction and case, AC			3.6	°C/W

※ : The gate trigger mode is shown below. **Package Dimensions 1144**
(unit: mm)

Trigger mode	T2	T1	G
I	+	-	+
II	+	-	-
III	-	+	+
IV	-	+	-

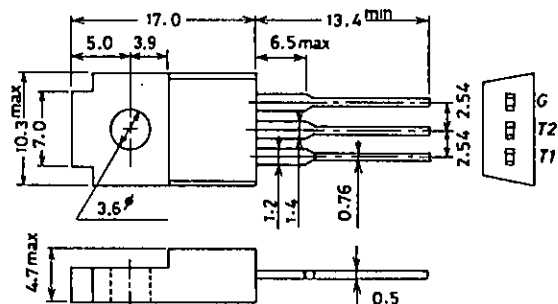

DTM8-N

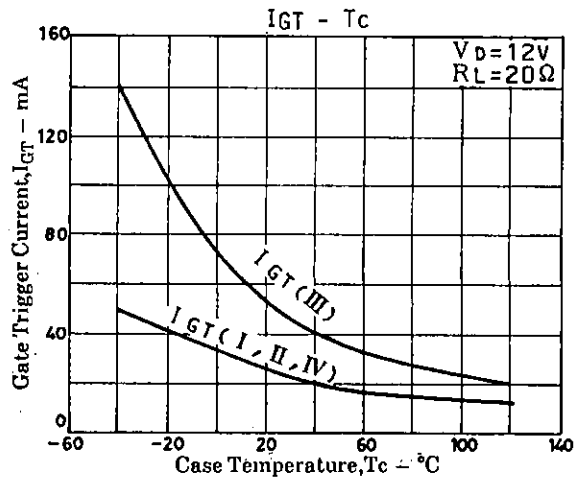
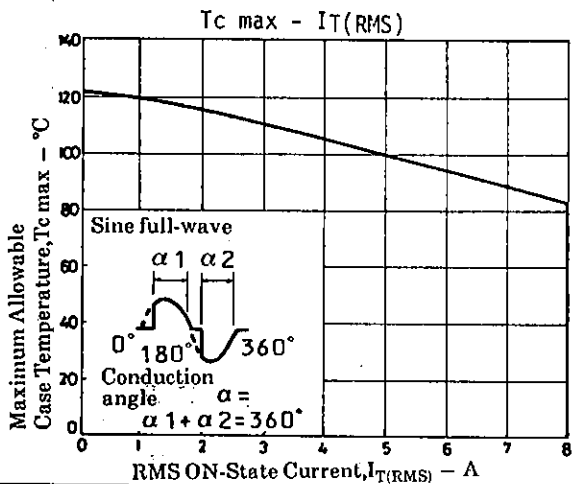
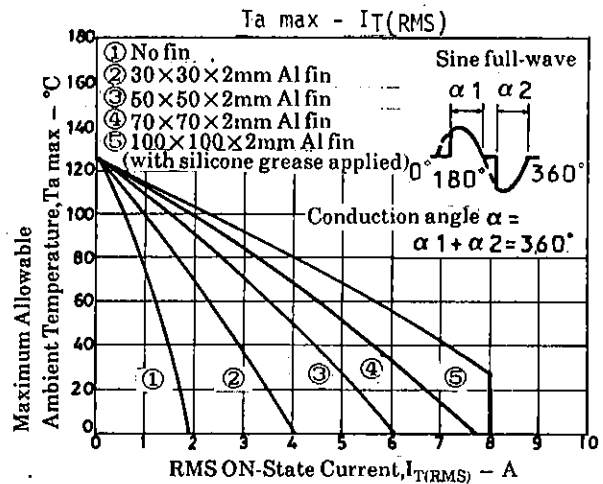
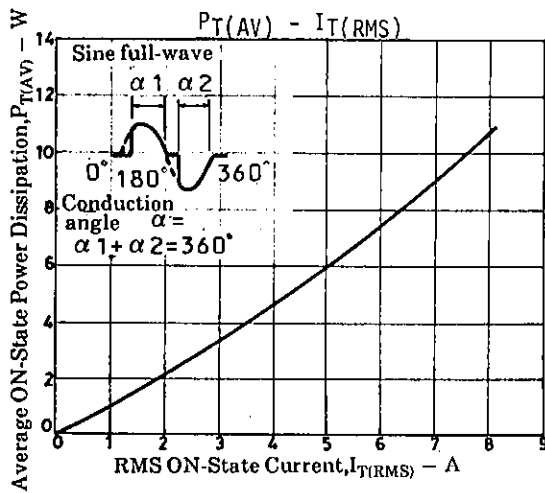
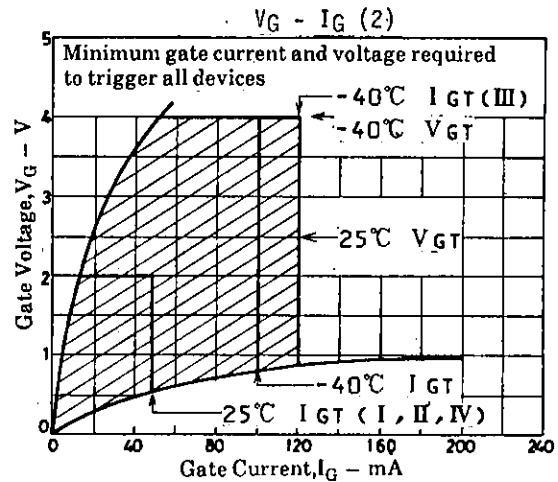
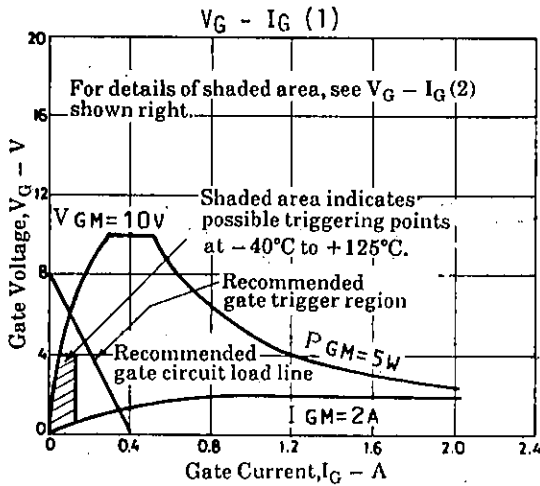
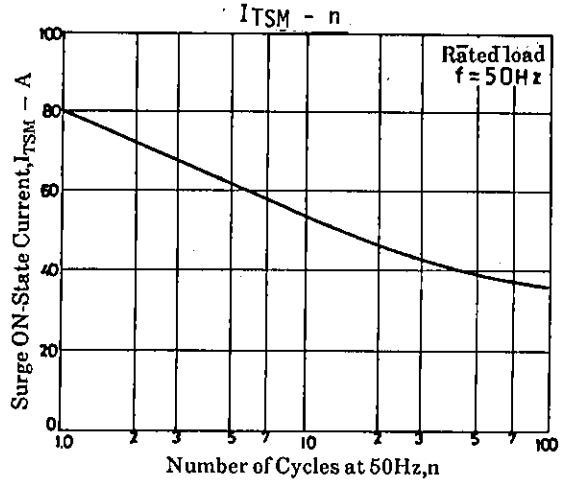
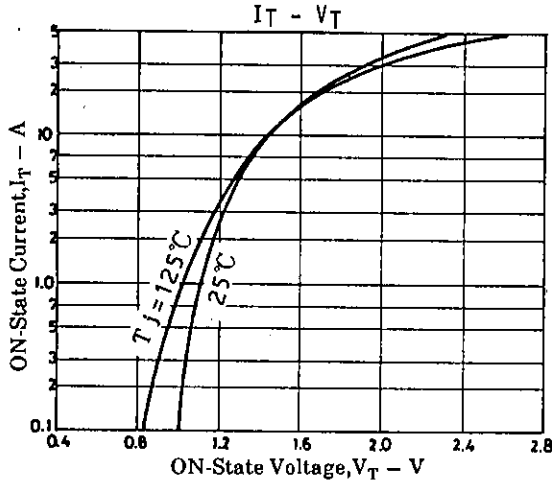

DTM8-N

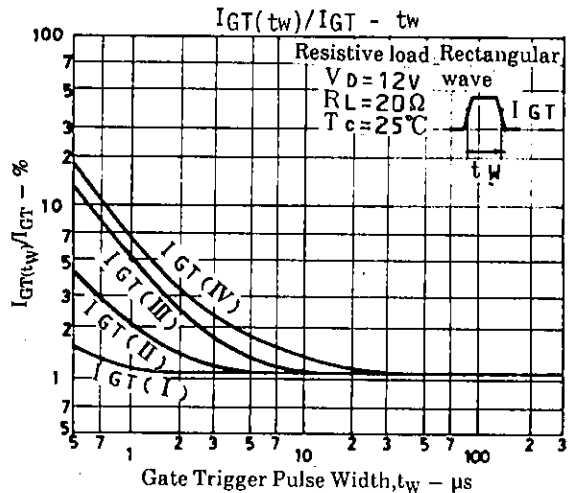
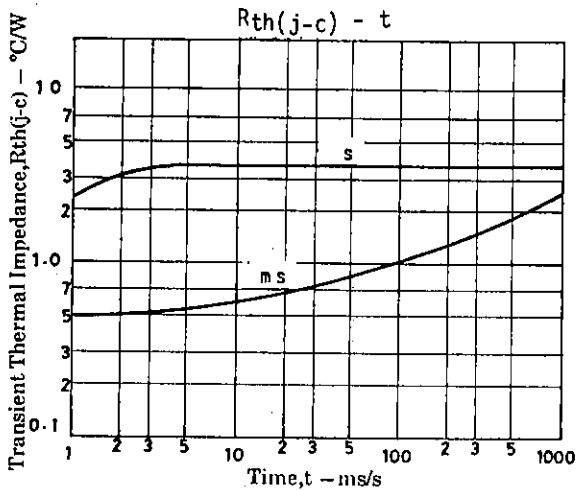
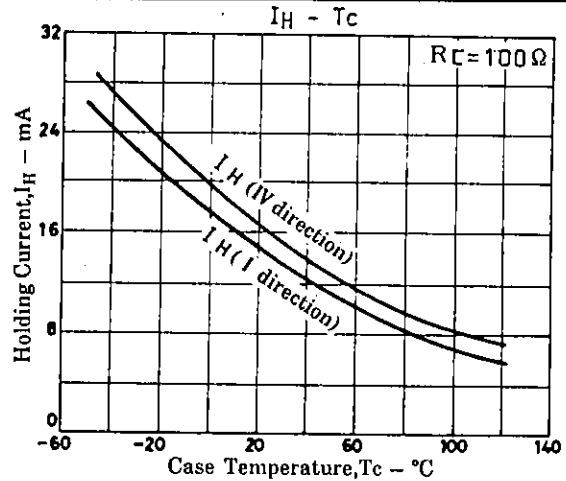
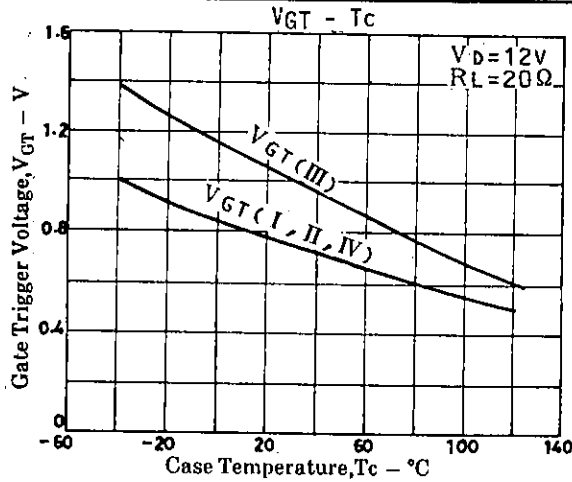

- No products described or contained herein are intended for use in surgical implants, life-support systems, aerospace equipment, nuclear power control systems, vehicles, disaster/crime-prevention equipment and the like, the failure of which may directly or indirectly cause injury, death or property loss.
- Anyone purchasing any products described or contained herein for an above-mentioned use shall:
 - ① Accept full responsibility and indemnify and defend SANYO ELECTRIC CO., LTD., its affiliates, subsidiaries and distributors and all their officers and employees, jointly and severally, against any and all claims and litigation and all damages, cost and expenses associated with such use:
 - ② Not impose any responsibility for any fault or negligence which may be cited in any such claim or litigation on SANYO ELECTRIC CO., LTD., its affiliates, subsidiaries and distributors or any of their officers and employees jointly or severally.
- Information (including circuit diagrams and circuit parameters) herein is for example only; it is not guaranteed for volume production. SANYO believes information herein is accurate and reliable, but no guarantees are made or implied regarding its use or any infringements of intellectual property rights or rights of third parties.