

SANYO

No.1878B

DTM6-N

Silicon Planar Type

6A Bidirectional Thyristor

Features

- Insulation type
- Peak OFF-state voltage : 200 to 600V
- RMS ON-state current : 6A
- TO-220 package

Absolute Maximum Ratings at Ta = 25°C

			DTM6C-N	DTM6E-N	DTM6G-N	unit
Repetitive Peak OFF-State Voltage	V_{DRM}		200	400	600	V
RMS ON-State Current	$I_{T(RMS)}$	$T_c = 70^\circ C$, single-phase full-wave	→	→	6	A
Surge ON-State Current	I_{TSM}	Peak 1 cycle, 50Hz	→	→	60	A
Amperes Squared-Seconds	$\int i^2 T \cdot dt$	$1ms \leq t \leq 10ms$	→	→	18	A ² s
Peak Gate Power Dissipation	P_{GM}	$f \geq 50Hz, duty \leq 10\%$	→	→	5	W
Average Gate Power Dissipation	$P_{G(AV)}$		→	→	0.5	W
Peak Gate Current	I_{GM}	$f \geq 50Hz, duty \leq 10\%$	→	→	±2	A
Peak Gate Voltage	V_{GM}	$f \geq 50Hz, duty \leq 10\%$	→	→	±10	V
Junction Temperature	T_j		→	→	125	°C
Storage Temperature	T_{stg}		→	→	-40 to +125	°C
Weight			→	→	2.1	g

Electrical Characteristics at Ta = 25°C

			min	typ	max	unit
Repetitive Peak OFF-State Current	I_{DRM}	$T_j = 125^\circ C, V_D = V_{DRM}$			2	mA
Peak ON-State Voltage	V_{TM}	$I_{TM} = 9A$			1.5	V
Critical Rate of Rise of OFF-State Voltage	(dv/dt) _C	$T_j = 125^\circ C, V_D = 200V (C), 400V (E \text{ to } G)$		10		V/μs
Holding Current	I_H	$R_L = 100\Omega$			50	mA
Gate Trigger Current* (I)	(I) I_{GT}	$V_D = 12V, R_L = 20\Omega$			30	mA
	(II) I_{GT}	$V_D = 12V, R_L = 20\Omega$			30	mA
	(III) I_{GT}	$V_D = 12V, R_L = 20\Omega$			50	mA
	(IV) I_{GT}	$V_D = 12V, R_L = 20\Omega$			30	mA
Gate Trigger Voltage* (I)	(I) V_{GT}	$V_D = 12V, R_L = 20\Omega$			2	V
	(II) V_{GT}	$V_D = 12V, R_L = 20\Omega$			2	V
	(III) V_{GT}	$V_D = 12V, R_L = 20\Omega$			2	V
	(IV) V_{GT}	$V_D = 12V, R_L = 20\Omega$			2	V
Gate Nontrigger Voltage	V_{GD}	$T_c = 125^\circ C, V_D = V_{DRM}$		0.2		V
Thermal Resistance	$R_{th(j-c)}$	Between junction and case, AC			3.8	°C/W

* : The gate trigger mode is shown below.

Trigger mode	T2	T1	G
I	+	-	+
II	+	-	-
III	-	+	+
IV	-	+	-

Package Dimensions 1144

(unit: mm)

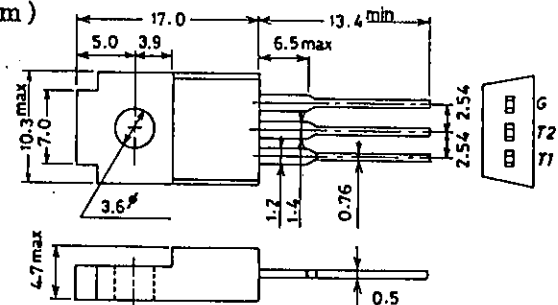

DTM6-N

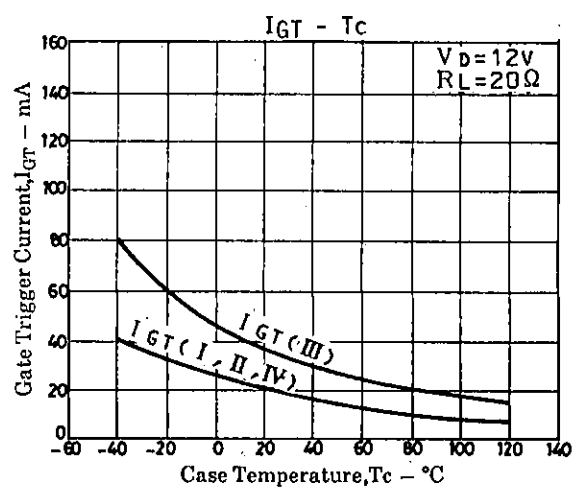
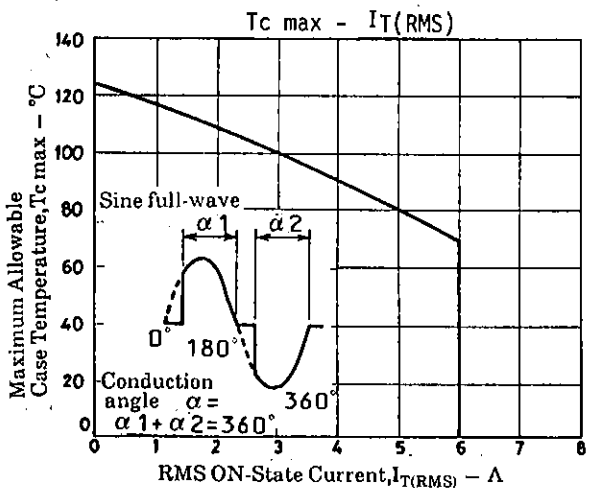
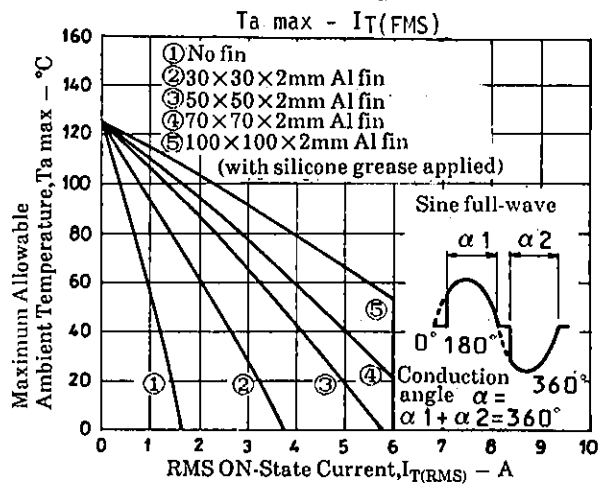
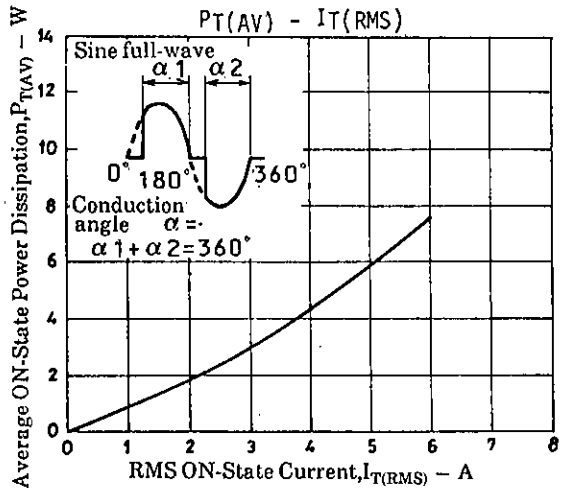
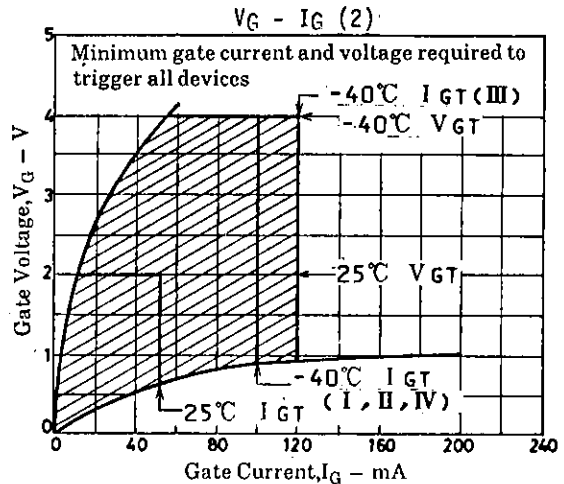
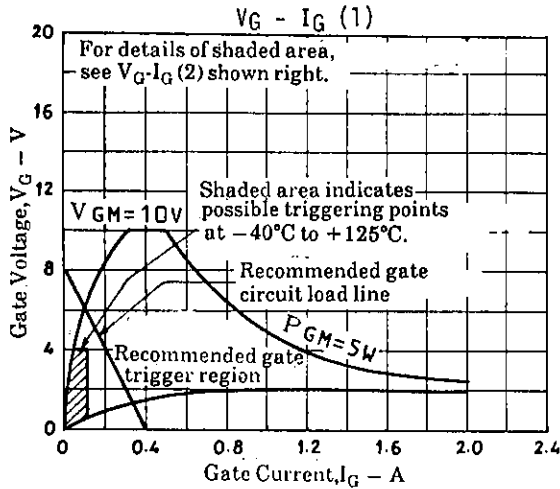
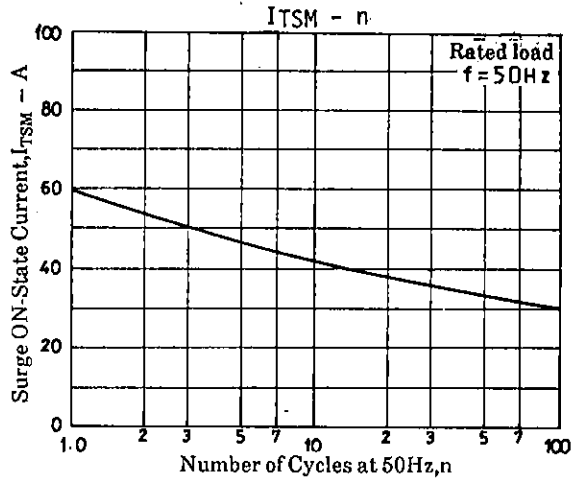
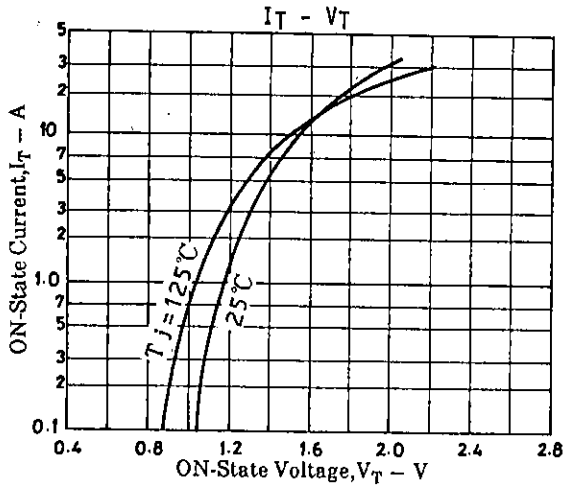

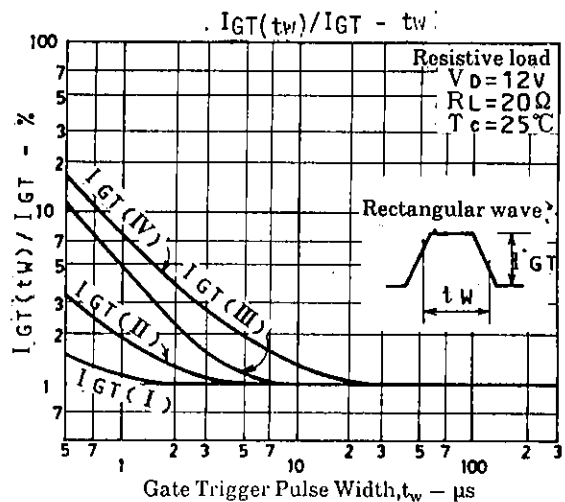
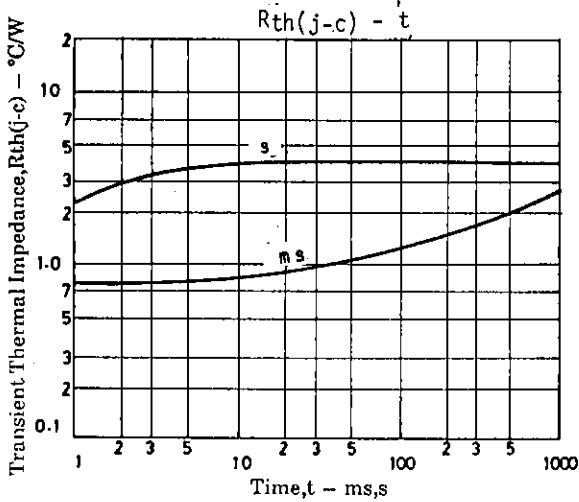
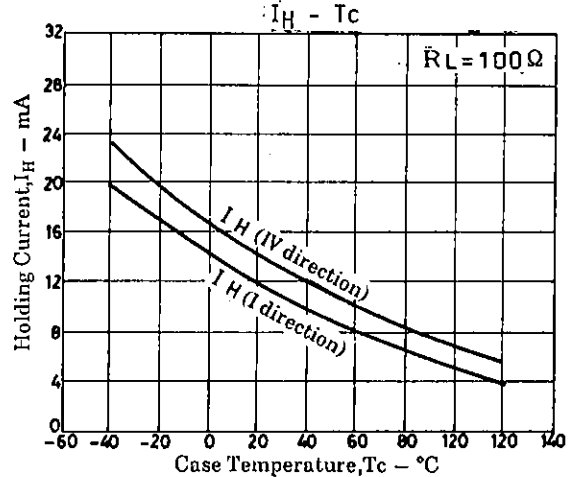
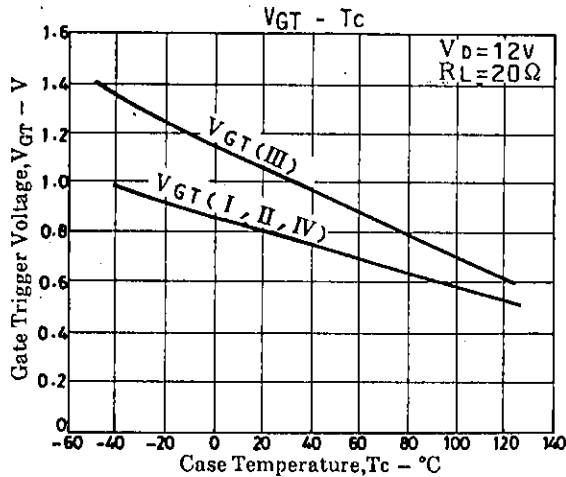

■ No products described or contained herein are intended for use in surgical implants, life-support systems, aerospace equipment, nuclear power control systems, vehicles, disaster/crime-prevention equipment and the like, the failure of which may directly or indirectly cause injury, death or property loss.

■ Anyone purchasing any products described or contained herein for an above-mentioned use shall:

- ① Accept full responsibility and indemnify and defend SANYO ELECTRIC CO., LTD., its affiliates, subsidiaries and distributors and all their officers and employees, jointly and severally, against any and all claims and litigation and all damages, cost and expenses associated with such use;
- ② Not impose any responsibility for any fault or negligence which may be cited in any such claim or litigation on SANYO ELECTRIC CO., LTD., its affiliates, subsidiaries and distributors or any of their officers and employees jointly or severally.

■ Information (including circuit diagrams and circuit parameters) herein is for example only; it is not guaranteed for volume production. SANYO believes information herein is accurate and reliable, but no guarantees are made or implied regarding its use or any infringements of intellectual property rights or other rights of third parties.