

Digital transistor (built-in resistors) Driver (60V, 2A) DTDS14GP

●Features

- 1) High h_{FE} .
 $h_{FE} = 1500$ (Typ.) ($V_{CE}/I_C = 5V/1A$)
- 2) Low $V_{CE(sat)}$.
 $V_{CE(sat)} = 0.16V$ (Typ.)
($I_C/I_B = 1A/10mA$)
- 3) Built-in zener diode for strong protection against reverse surges due to low loads.

●Structure

NPN digital transistor
(Built-in resistor type)

●External dimensions (Units: mm)

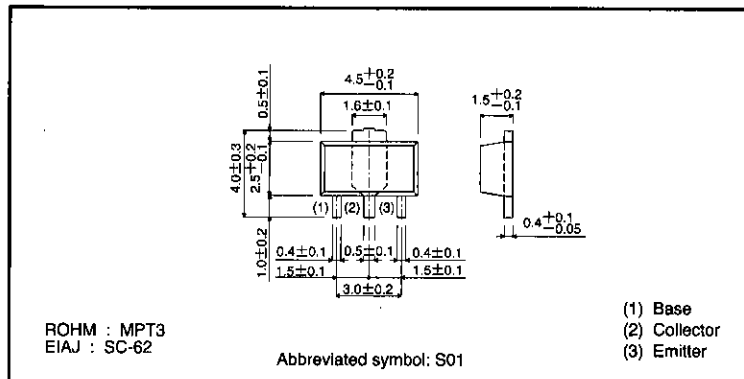

●Absolute maximum ratings ($T_a = 25^\circ C$)

Parameter	Symbol	Limits	Unit
Collector-base voltage	V_{CBO}	60 ± 10	V
Collector-emitter voltage	V_{CEO}	60 ± 10	V
Emitter-base voltage	V_{EBO}	10	V
Collector current	I_C	2	A
	I_{CP}	4	A (Pulse) *1
Base current	I_B	0.03	A
Collector power dissipation	P_C	0.5	W *2
		2	
Junction temperature	T_J	150	$^\circ C$
Storage temperature	T_{stg}	$-55 \sim 150$	$^\circ C$

*1 $P_w \leq 10ms$, Duty $\leq 1/2$

*2 On 40 x 40 x 0.7 mm ceramic board.

●Equivalent circuit

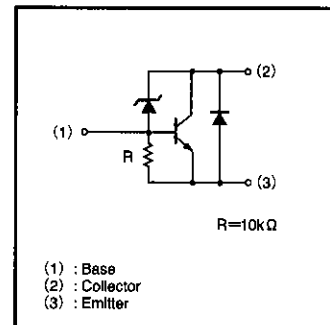

Digital transistors

●Electrical characteristics (Ta = 25°C)

Parameter	Symbol	Min.	Typ.	Max.	Unit	Conditions
Collector-base breakdown voltage	BV_{CBO}	50	—	70	V	$I_C=50\mu A$
Collector-emitter breakdown voltage	BV_{CEO}	50	—	70	V	$I_C=50\mu A$
Collector cutoff current	I_{CBO}	—	—	0.5	μA	$V_{CB}=40V$
Emitter cutoff current	I_{EBO}	0.77	—	1.43	mA	$V_{EB}=10V$
Collector-emitter saturation voltage	$V_{CE(sat)}$	—	—	0.3	V	$I_C/I_B=1A/10mA$
DC current transfer ratio	h_{FE}	700	—	—	—	$V_{CE}=5V, I_C=200mA$ *1
		1000	—	—	—	$V_{CE}=5V, I_C=1A$ *1
		500	—	—	—	$V_{CE}=5V, I_C=2A$ *1
Transition frequency	f_T	—	300	—	MHz	$V_{CE}=5V, I_E=-0.5A, f=100MHz$ *2
Emitter-base resistance	R	7	10	13	k Ω	—
Diode forward voltage	V_F	—	—	1.5	V	$I_F=1.0A$

*1 Measured using pulse current.

*2 Transition frequency of mounted transistor.

●Packaging specifications

Type	Package	MPT3
	Package style	Taping
	Code	T100
	Basic ordering unit (pieces)	1000
DTDS14GP		○

●Electrical characteristic curves

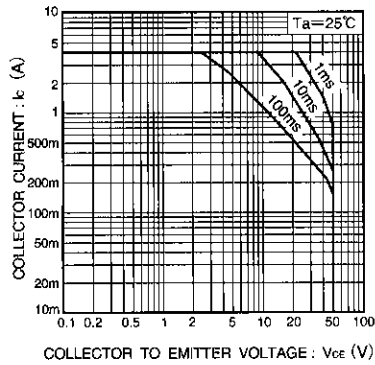

Fig.1 Safe operating area

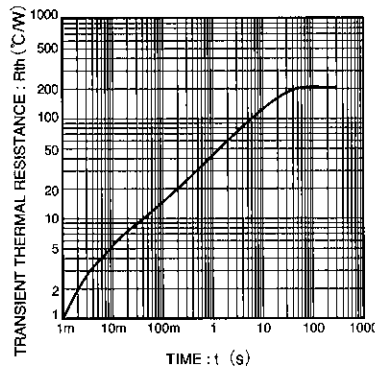

Fig.2 Transient thermal resistance

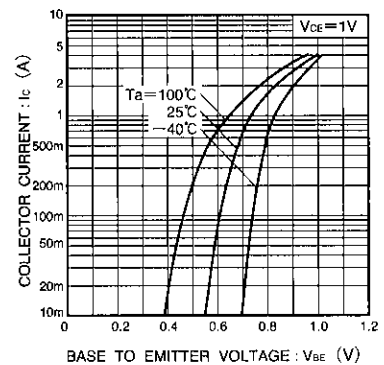

Fig.3 Grounded emitter propagation characteristics

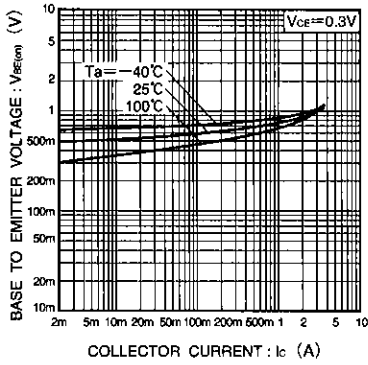

Fig.4 Grounded emitter propagation characteristics

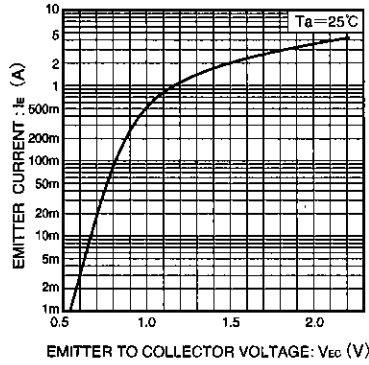

Fig.5 Emitter-collector diode forward characteristics

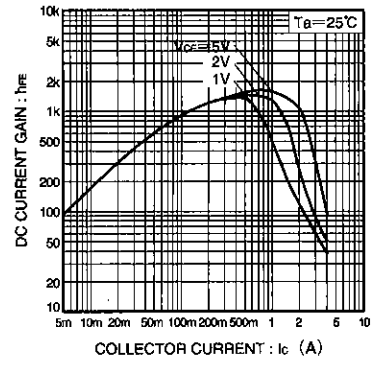

Fig.6 DC current gain vs. collector current (I)

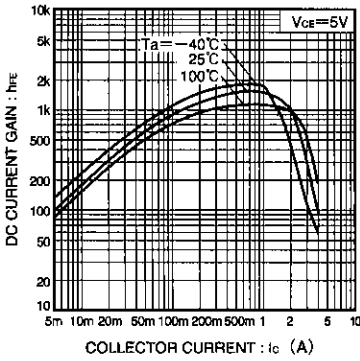

Fig.7 DC current gain vs. collector current (II)

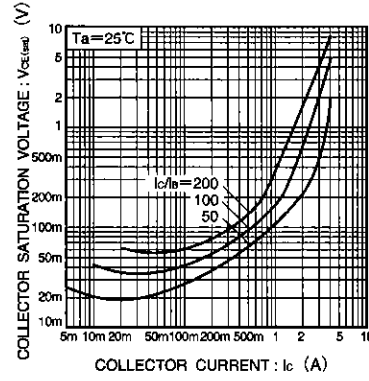

Fig.8 Collector-emitter saturation voltage vs. collector current (I)

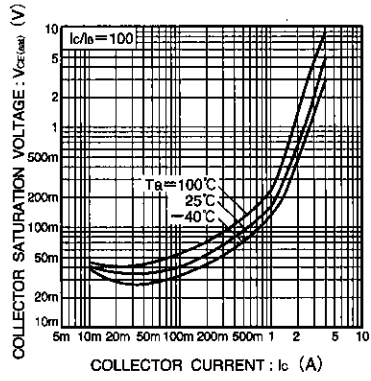

Fig.9 Collector-emitter saturation voltage vs. collector current (II)

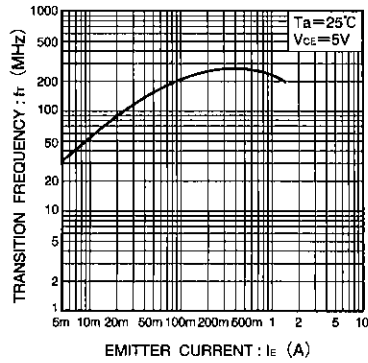

Fig.10 Gain bandwidth product vs. emitter current

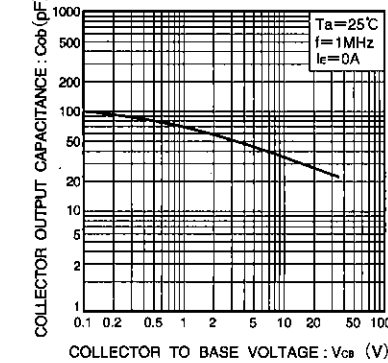

Fig.11 Collector output capacitance vs. collector-base voltage

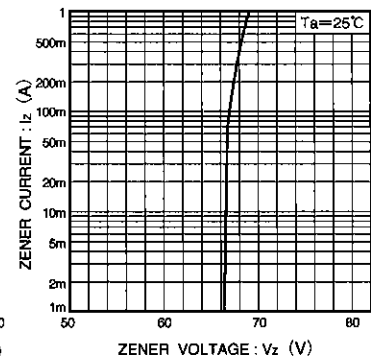

Fig.12 Zener characteristics

Digital transistors

Notes

- The contents described in this catalogue are correct as of March 1997.
- No unauthorized transmission or reproduction of this book, either in whole or in part, is permitted.
- The contents of this book are subject to change without notice. Always verify before use that the contents are the latest specifications. If, by any chance, a defect should arise in the equipment as a result of use without verification of the specifications, ROHM CO., LTD., can bear no responsibility whatsoever.
- Application circuit diagrams and circuit constants contained in this data book are shown as examples of standard use and operation. When designing for mass production, please pay careful attention to peripheral conditions.
- Any and all data, including, but not limited to application circuit diagrams, information, and various data, described in this catalogue are intended only as illustrations of such devices and not as the specifications for such devices. ROHM CO., LTD., disclaims any warranty that any use of such device shall be free from infringement of any third party's intellectual property rights or other proprietary rights, and further, assumes absolutely no liability in the event of any such infringement, or arising from or connected with or related to the use of such devices.
- Upon the sale of any such devices; other than for the buyer's right to use such devices itself, resell or otherwise dispose of the same; no express or implied right or license to practice or commercially exploit any intellectual property rights or other proprietary rights owned or controlled by ROHM CO., LTD., is granted to any such buyer.

The products listed in this catalogue are designed to be used with ordinary electronic equipment or devices (such as audio-visual equipment, office-automation equipment, communications devices, electrical appliances, and electronic toys). Should you intend to use these products with equipment or devices which require an extremely high level of reliability and the malfunction of which would directly endanger human life (such as medical instruments, transportation equipment, aerospace machinery, nuclear-reactor controllers, fuel controllers, or other safety devices) please be sure to consult with our sales representatives in advance.

- Notes when exporting
 - It is essential to obtain export permission when exporting any of the above products when it falls under the category of strategic material (or labor) as determined by foreign exchange or foreign trade control laws.
 - Please be sure to consult with our sales representatives to ascertain whether any product is classified as a strategic material.