

## N - CHANNEL ENHANCEMENT MODE LOW THRESHOLD POWER MOS TRANSISTOR

TYPE	V <sub>DSS</sub>	R <sub>DS(on)</sub>	I <sub>D</sub>
STD12N05L	50 V	< 0.15 Ω	12 A
STD12N06L	60 V	< 0.15 Ω	12 A

- TYPICAL R<sub>DS(on)</sub> = 0.115 Ω
- AVALANCHE RUGGED TECHNOLOGY
- 100% AVALANCHE TESTED
- REPETITIVE AVALANCHE DATA AT 100°C
- LOW GATE CHARGE
- LOGIC LEVEL COMPATIBLE INPUT
- 175°C OPERATING TEMPERATURE
- APPLICATION ORIENTED CHARACTERIZATION
- THROUGH-HOLE IPAK (TO-251) POWER PACKAGE IN TUBE (SUFFIX "-1")
- SURFACE-MOUNTING DPAK (TO-252) POWER PACKAGE IN TAPE & REEL (SUFFIX "T4")

### APPLICATIONS

- HIGH CURRENT, HIGH SPEED SWITCHING
- SOLENOID AND RELAY DRIVERS
- REGULATORS
- DC-DC & DC-AC CONVERTERS
- MOTOR CONTROL, AUDIO AMPLIFIERS
- AUTOMOTIVE ENVIRONMENT (INJECTION, ABS, AIR-BAG, LAMPDRIVERS, Etc.)

### ABSOLUTE MAXIMUM RATINGS

Symbol	Parameter	Value		Unit
		STD12N05L	STD12N06L	
V <sub>DS</sub>	Drain-source Voltage (V <sub>GS</sub> = 0)	50	60	V
V <sub>DGR</sub>	Drain- gate Voltage (R <sub>GS</sub> = 20 kΩ)	50	60	V
V <sub>GS</sub>	Gate-source Voltage	± 15		V
I <sub>D</sub>	Drain Current (continuous) at T <sub>c</sub> = 25 °C	12		A
I <sub>D</sub>	Drain Current (continuous) at T <sub>c</sub> = 100 °C	8		A
I <sub>DM</sub> (•)	Drain Current (pulsed)	48		A
P <sub>tot</sub>	Total Dissipation at T <sub>c</sub> = 25 °C	45		W
	Derating Factor	0.3		W/°C
T <sub>stg</sub>	Storage Temperature	-65 to 175		°C
T <sub>j</sub>	Max. Operating Junction Temperature	175		°C

(•) Pulse width limited by safe operating area

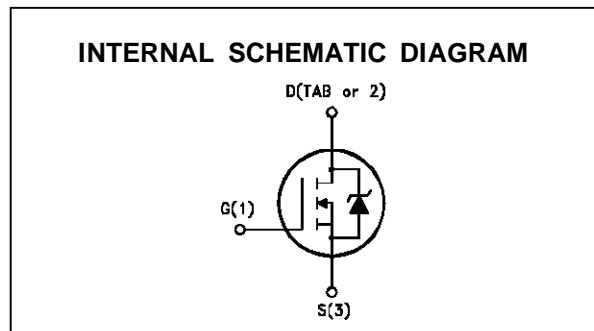
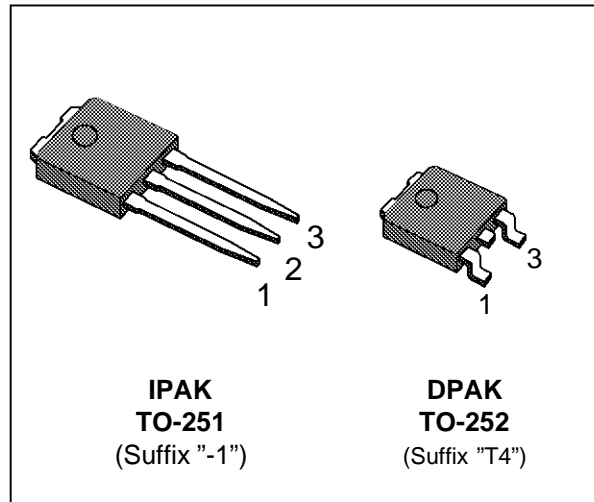

## STD12N05L/STD12N06L

### THERMAL DATA

$R_{thj-case}$	Thermal Resistance Junction-case	Max	3.33	$^{\circ}C/W$
$R_{thj-amb}$	Thermal Resistance Junction-ambient	Max	100	$^{\circ}C/W$
$R_{thc-sink}$	Thermal Resistance Case-sink	Typ	1.5	$^{\circ}C/W$
$T_l$	Maximum Lead Temperature For Soldering Purpose		275	$^{\circ}C$

### AVALANCHE CHARACTERISTICS

Symbol	Parameter	Max Value	Unit
$I_{AR}$	Avalanche Current, Repetitive or Not-Repetitive (pulse width limited by $T_j$ max, $\delta < 1\%$ )	12	A
$E_{AS}$	Single Pulse Avalanche Energy (starting $T_j = 25^{\circ}C$ , $I_D = I_{AR}$ , $V_{DD} = 25 V$ )	30	mJ
$E_{AR}$	Repetitive Avalanche Energy (pulse width limited by $T_j$ max, $\delta < 1\%$ )	7	mJ
$I_{AR}$	Avalanche Current, Repetitive or Not-Repetitive ( $T_c = 100^{\circ}C$ , pulse width limited by $T_j$ max, $\delta < 1\%$ )	8	A

### ELECTRICAL CHARACTERISTICS ( $T_{case} = 25^{\circ}C$ unless otherwise specified)

OFF

Symbol	Parameter	Test Conditions	Min.	Typ.	Max.	Unit
$V_{(BR)DSS}$	Drain-source Breakdown Voltage	$I_D = 250 \mu A$ $V_{GS} = 0$ for <b>STD12N05L</b> for <b>STD12N06L</b>	50 60			V V
$I_{DSS}$	Zero Gate Voltage Drain Current ( $V_{GS} = 0$ )	$V_{DS} = \text{Max Rating}$ $V_{DS} = \text{Max Rating} \times 0.8$ $T_c = 125^{\circ}C$			1 10	$\mu A$ $\mu A$
$I_{GSS}$	Gate-body Leakage Current ( $V_{DS} = 0$ )	$V_{GS} = \pm 15 V$			$\pm 100$	nA

ON (\*)

Symbol	Parameter	Test Conditions	Min.	Typ.	Max.	Unit
$V_{GS(th)}$	Gate Threshold Voltage	$V_{DS} = V_{GS}$ $I_D = 250 \mu A$	1	1.6	2.5	V
$R_{DS(on)}$	Static Drain-source On Resistance	$V_{GS} = 5 V$ $I_D = 6 A$		0.115	0.15	$\Omega$
$I_{D(on)}$	On State Drain Current	$V_{DS} > I_{D(on)} \times R_{DS(on)max}$ $V_{GS} = 10 V$	12			A

DYNAMIC

Symbol	Parameter	Test Conditions	Min.	Typ.	Max.	Unit
$g_{fs} (*)$	Forward Transconductance	$V_{DS} > I_{D(on)} \times R_{DS(on)max}$ $I_D = 6 A$	4	8		S
$C_{iss}$	Input Capacitance	$V_{DS} = 25 V$ $f = 1 MHz$ $V_{GS} = 0$		350	500	pF
$C_{oss}$	Output Capacitance			150	200	pF
$C_{rss}$	Reverse Transfer Capacitance			50	80	pF

**ELECTRICAL CHARACTERISTICS** (continued)

**SWITCHING ON**

Symbol	Parameter	Test Conditions	Min.	Typ.	Max.	Unit
$t_{d(on)}$ $t_r$	Turn-on Time Rise Time	$V_{DD} = 25\text{ V}$ $I_D = 6\text{ A}$ $R_G = 50\ \Omega$ $V_{GS} = 5\text{ V}$ (see test circuit, figure 3)		55 180	80 260	ns ns
$(di/dt)_{on}$	Turn-on Current Slope	$V_{DD} = 40\text{ V}$ $I_D = 12\text{ A}$ $R_G = 50\ \Omega$ $V_{GS} = 5\text{ V}$ (see test circuit, figure 5)		120		A/ $\mu$ s
$Q_g$ $Q_{gs}$ $Q_{gd}$	Total Gate Charge Gate-Source Charge Gate-Drain Charge	$V_{DD} = 40\text{ V}$ $I_D = 12\text{ A}$ $V_{GS} = 5\text{ V}$		12 6 5	18	nC nC nC

**SWITCHING OFF**

Symbol	Parameter	Test Conditions	Min.	Typ.	Max.	Unit
$t_{r(Voff)}$ $t_f$ $t_c$	Off-voltage Rise Time Fall Time Cross-over Time	$V_{DD} = 40\text{ V}$ $I_D = 12\text{ A}$ $R_G = 50\ \Omega$ $V_{GS} = 5\text{ V}$ (see test circuit, figure 5)		40 60 110	60 90 160	ns ns ns

**SOURCE DRAIN DIODE**

Symbol	Parameter	Test Conditions	Min.	Typ.	Max.	Unit
$I_{SD}$ $I_{SDM}(\bullet)$	Source-drain Current Source-drain Current (pulsed)				12 48	A A
$V_{SD} (*)$	Forward On Voltage	$I_{SD} = 12\text{ A}$ $V_{GS} = 0$			1.5	V
$t_{rr}$ $Q_{rr}$ $I_{RRM}$	Reverse Recovery Time Reverse Recovery Charge Reverse Recovery Current	$I_{SD} = 12\text{ A}$ $di/dt = 100\text{ A}/\mu\text{s}$ $V_{DD} = 25\text{ V}$ $T_j = 150\text{ }^\circ\text{C}$ (see test circuit, figure 5)		75 0.15 4		ns $\mu$ C A

(\*) Pulsed: Pulse duration = 300  $\mu$ s, duty cycle 1.5%

( $\bullet$ ) Pulse width limited by safe operating area

**Safe Operating Areas**

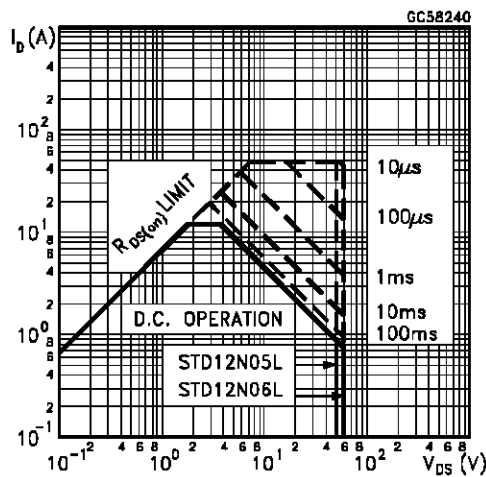

**Thermal Impedance**

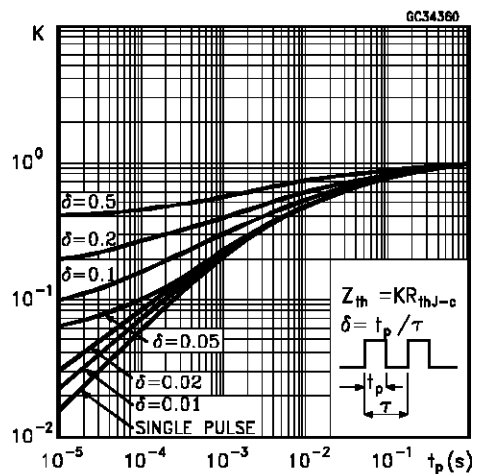

Derating Curve

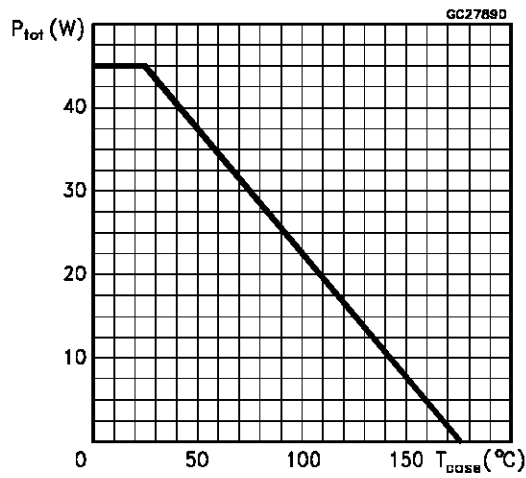

Output Characteristics

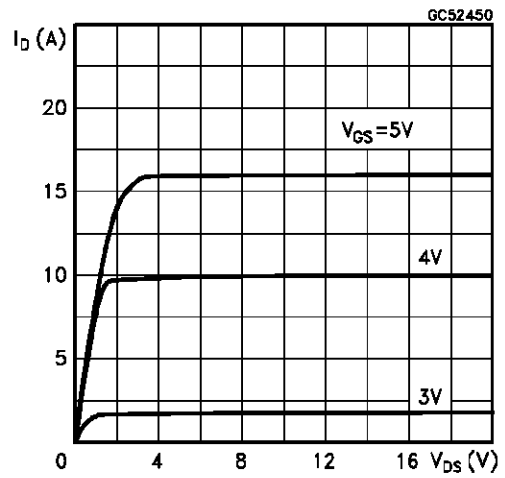

Transfer Characteristics

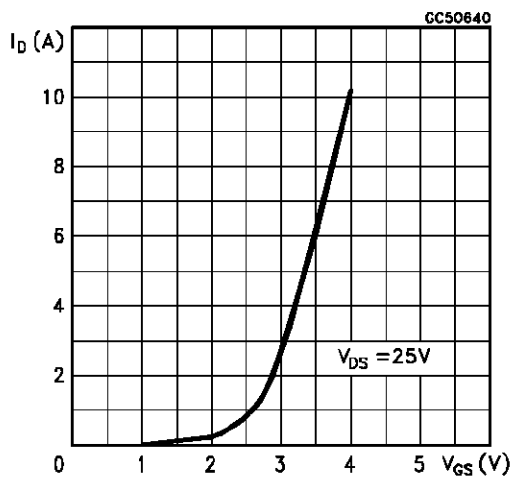

Transconductance

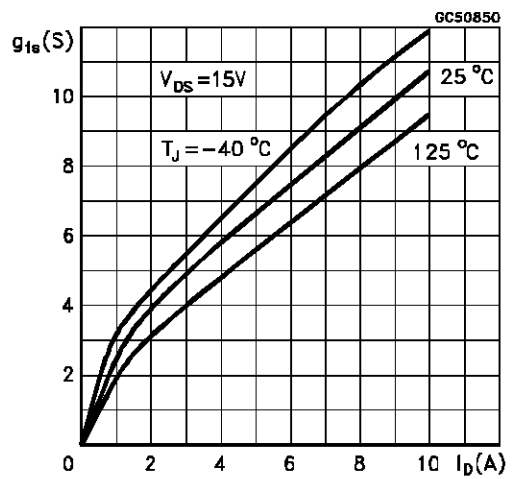

Static Drain-source On Resistance

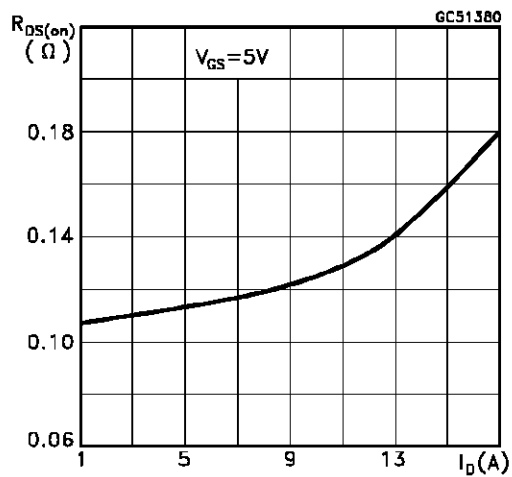

Gate Charge vs Gate-source Voltage

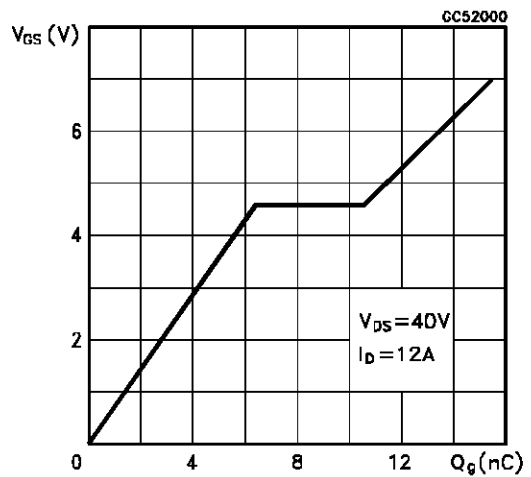

Capacitance Variations

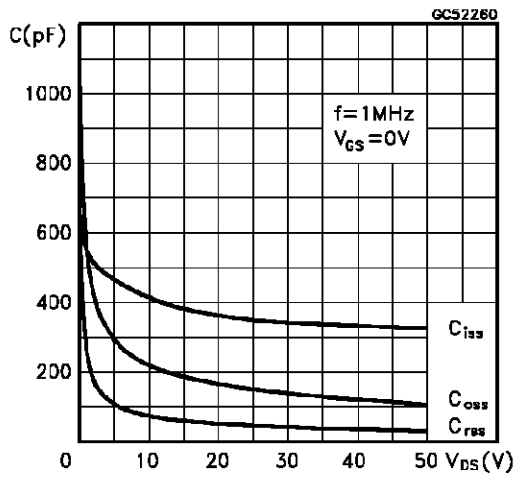

Normalized Gate Threshold Voltage vs Temperature

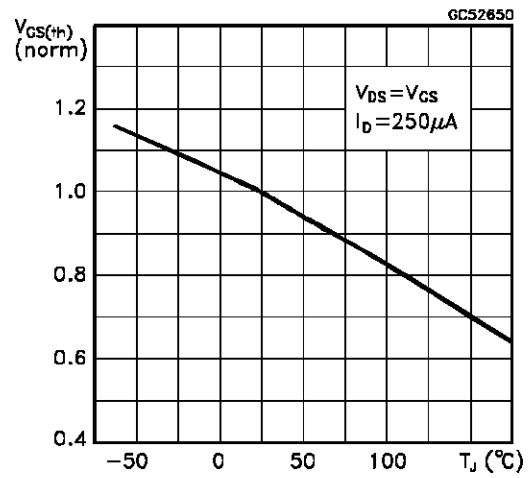

Normalized On Resistance vs Temperature

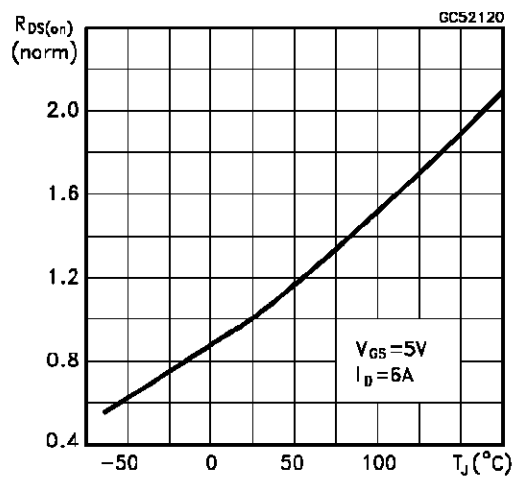

Turn-on Current Slope

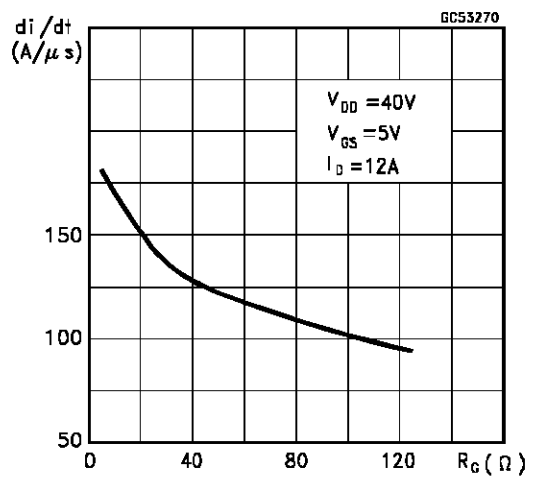

Turn-off Drain-source Voltage Slope

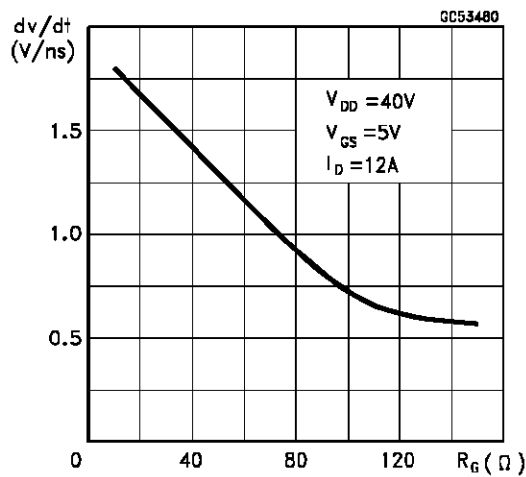

Cross-over Time

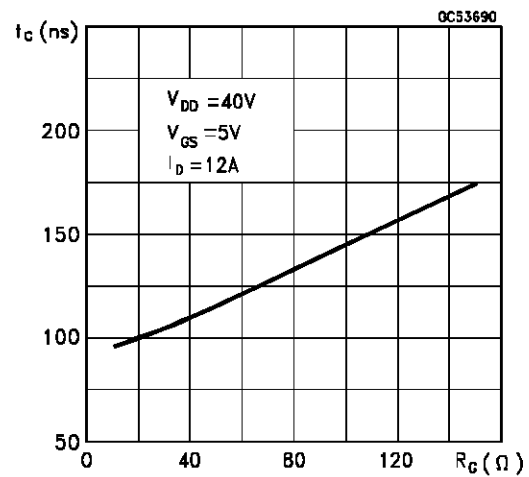

Switching Safe Operating Area

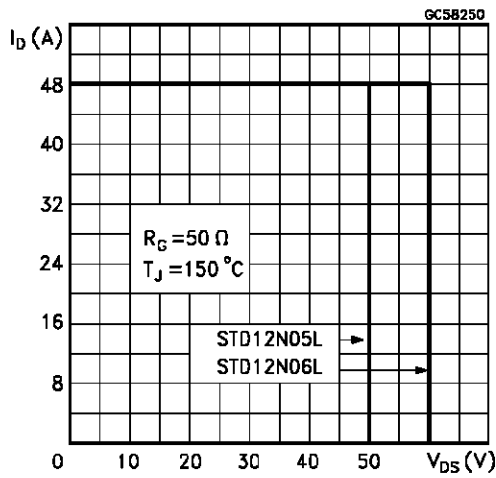

Accidental Overload Area

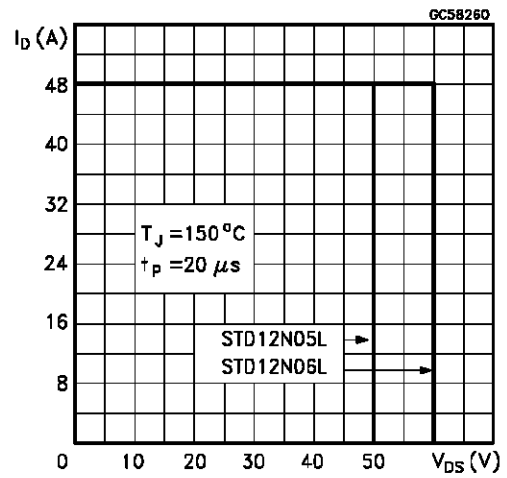

Source-drain Diode Forward Characteristics

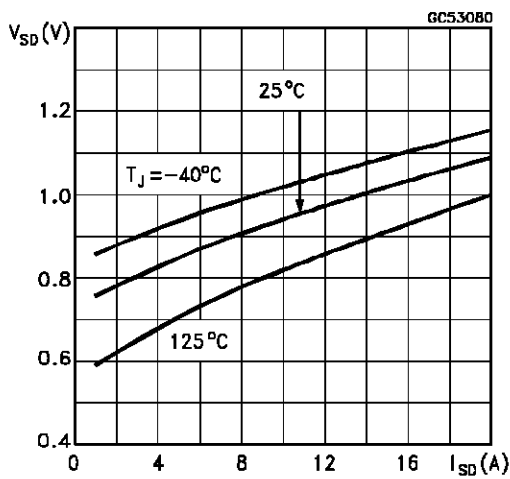

Fig. 1: Unclamped Inductive Load Test Circuits

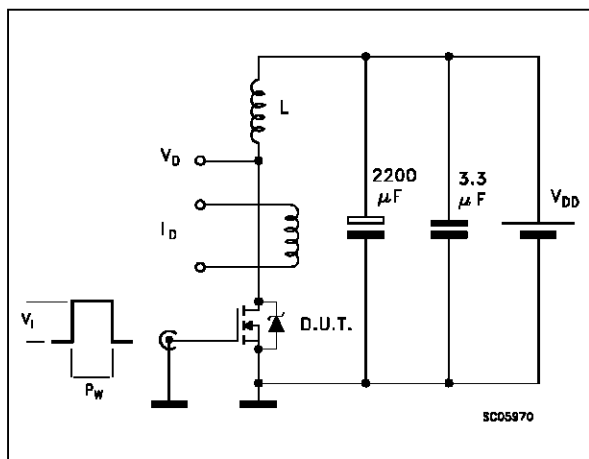
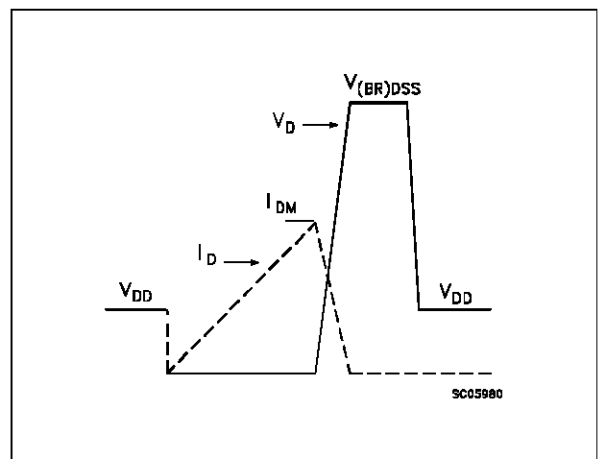

Fig. 2: Unclamped Inductive Waveforms



**Fig. 3:** Switching Times Test Circuits For Resistive Load



**Fig. 4:** Gate Charge Test Circuit



**Fig. 5:** Test Circuit For Inductive Load Switching And Diode Reverse Recovery Time

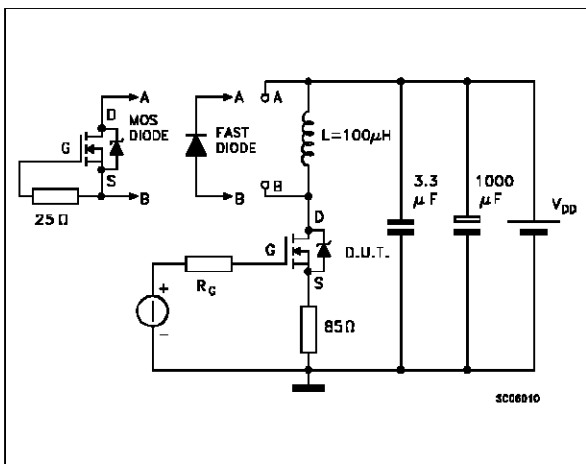

**TO-251 (IPAK) MECHANICAL DATA**

DIM.	mm			inch		
	MIN.	TYP.	MAX.	MIN.	TYP.	MAX.
A	2.2		2.4	0.086		0.094
A1	0.9		1.1	0.035		0.043
A3	0.7		1.3	0.027		0.051
B	0.64		0.9	0.025		0.031
B2	5.2		5.4	0.204		0.212
B3			0.85			0.033
B5		0.3			0.012	
B6			0.95			0.037
C	0.45		0.6	0.017		0.023
C2	0.48		0.6	0.019		0.023
D	6		6.2	0.236		0.244
E	6.4		6.6	0.252		0.260
G	4.4		4.6	0.173		0.181
H	15.9		16.3	0.626		0.641
L	9		9.4	0.354		0.370
L1	0.8		1.2	0.031		0.047
L2		0.8	1		0.031	0.039





**TO-252 (DPAK) MECHANICAL DATA**

DIM.	mm			inch		
	MIN.	TYP.	MAX.	MIN.	TYP.	MAX.
A	2.2		2.4	0.086		0.094
A1	0.9		1.1	0.035		0.043
A2	0.03		0.23	0.001		0.009
B	0.64		0.9	0.025		0.035
B2	5.2		5.4	0.204		0.212
C	0.45		0.6	0.017		0.023
C2	0.48		0.6	0.019		0.023
D	6		6.2	0.236		0.244
E	6.4		6.6	0.252		0.260
G	4.4		4.6	0.173		0.181
H	9.35		10.1	0.368		0.397
L2		0.8			0.031	
L4	0.6		1	0.023		0.039

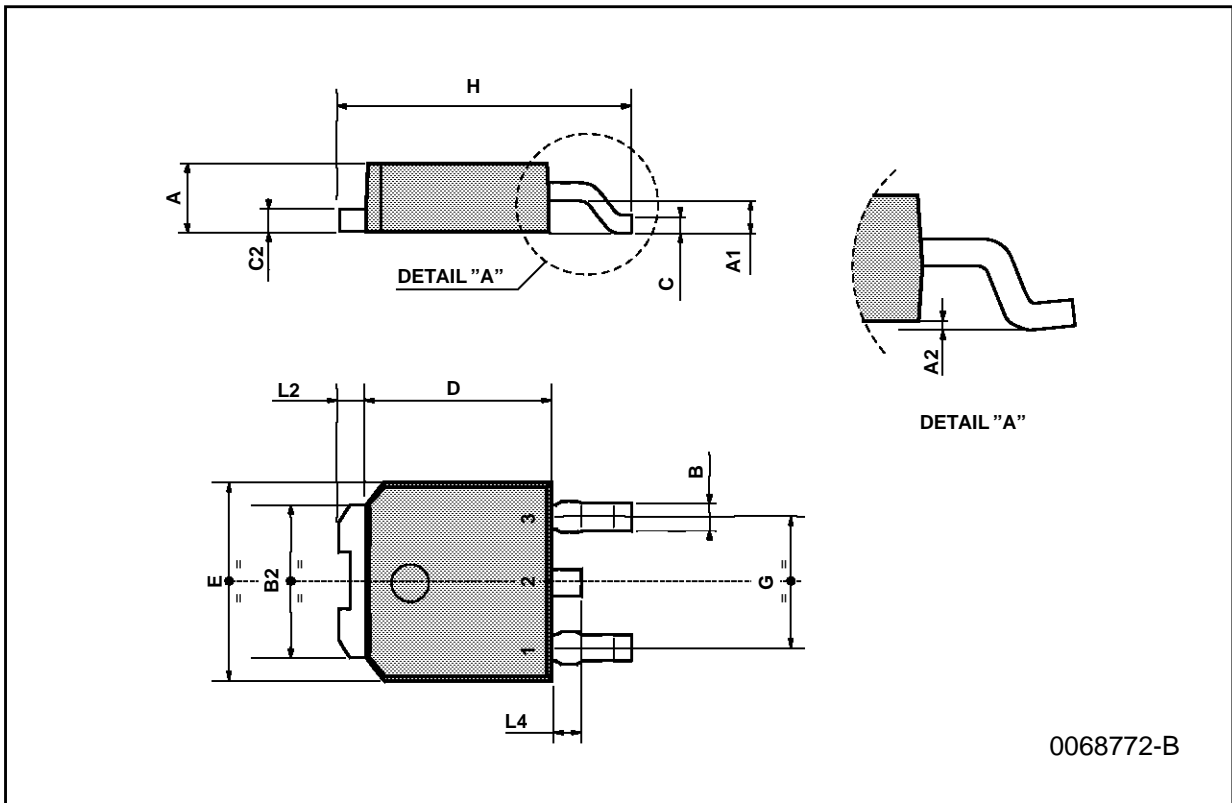

Information furnished is believed to be accurate and reliable. However, SGS-THOMSON Microelectronics assumes no responsibility for the consequences of use of such information nor for any infringement of patents or other rights of third parties which may result from its use. No license is granted by implication or otherwise under any patent or patent rights of SGS-THOMSON Microelectronics. Specifications mentioned in this publication are subject to change without notice. This publication supersedes and replaces all information previously supplied. SGS-THOMSON Microelectronics products are not authorized for use as critical components in life support devices or systems without express written approval of SGS-THOMSON Microelectronics.

© 1996 SGS-THOMSON Microelectronics - Printed in Italy - All Rights Reserved

SGS-THOMSON Microelectronics GROUP OF COMPANIES

Australia - Brazil - Canada - China - France - Germany - Hong Kong - Italy - Japan - Korea - Malaysia - Malta - Morocco - The Netherlands - Singapore - Spain - Sweden - Switzerland - Taiwan - Thailand - United Kingdom - U.S.A