

**Rectifier diodes  
ultrafast, rugged**

**BYW29EX series**

**GENERAL DESCRIPTION**

Glass passivated epitaxial rectifier diodes in a full pack plastic envelope, featuring low forward voltage drop, ultra-fast recovery times, soft recovery characteristic and guaranteed reverse surge and ESD capability. They are intended for use in switched mode power supplies and high frequency circuits in general where low conduction and switching losses are essential.

**QUICK REFERENCE DATA**

SYMBOL	PARAMETER	MAX.	MAX.	UNIT
$V_{RRM}$	Repetitive peak reverse voltage	150	200	V
$V_F$	Forward voltage	0.895	0.895	V
$I_{F(AV)}$	Forward current	8	8	A
$t_{rr}$	Reverse recovery time	25	25	ns
$I_{RRM}$	Repetitive peak reverse current	0.2	0.2	A

**PINNING - SOD113**

PIN	DESCRIPTION
1	cathode
2	anode
case	isolated

**PIN CONFIGURATION**

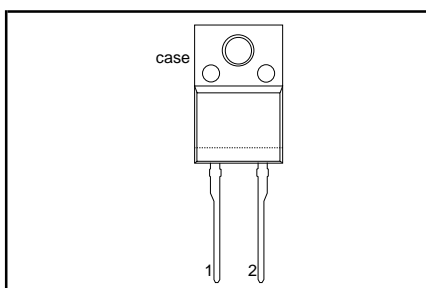

**SYMBOL**

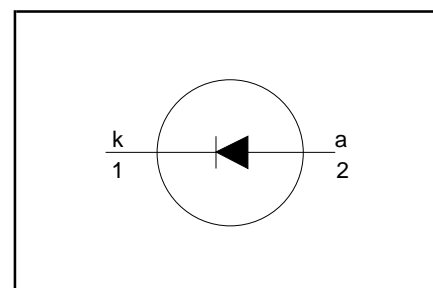

**LIMITING VALUES**

Limiting values in accordance with the Absolute Maximum System (IEC 134).

SYMBOL	PARAMETER	CONDITIONS	MIN.	MAX.		UNIT
$V_{RRM}$	Repetitive peak reverse voltage		-	-150	-200	V
$V_{RWM}$	Crest working reverse voltage		-	150	200	V
$V_R$	Continuous reverse voltage		-	150	200	V
$I_{F(AV)}$	Average forward current <sup>1</sup>	square wave; $\delta = 0.5$ ; $T_{hs} \leq 106^\circ\text{C}$ sinusoidal; $a = 1.57$ ; $T_{hs} \leq 109^\circ\text{C}$	-	8		A
$I_{F(RMS)}$	RMS forward current		-	7.3		A
$I_{FRM}$	Repetitive peak forward current	$t = 25 \mu\text{s}$ ; $\delta = 0.5$ ; $T_{hs} \leq 106^\circ\text{C}$	-	16		A
$I_{FSM}$	Non-repetitive peak forward current	$t = 10 \text{ ms}$ $t = 8.3 \text{ ms}$ sinusoidal; with reapplied	-	80		A
			-	88		A
$I^2t$	$I^2t$ for fusing	$V_{RWM(max)}$ $t = 10 \text{ ms}$	-	32		A <sup>2</sup> s
$I_{RRM}$	Repetitive peak reverse current	$t_p = 2 \mu\text{s}$ ; $\delta = 0.001$	-	0.2		A
$I_{RSM}$	Non-repetitive peak reverse current	$t_p = 100 \mu\text{s}$	-	0.2		A
$T_{stg}$	Storage temperature		-40	150		$^\circ\text{C}$
$T_j$	Operating junction temperature		-	150		$^\circ\text{C}$

<sup>1</sup> Neglecting switching and reverse current losses

Rectifier diodes  
ultrafast, rugged

## BYW29EX series

## ESD LIMITING VALUE

SYMBOL	PARAMETER	CONDITIONS	MIN.	MAX.	UNIT
$V_C$	Electrostatic discharge capacitor voltage	Human body model; $C = 250 \text{ pF}$ ; $R = 1.5 \text{ k}\Omega$	-	8	kV

## ISOLATION LIMITING VALUE &amp; CHARACTERISTIC

 $T_{hs} = 25 \text{ }^\circ\text{C}$  unless otherwise specified

SYMBOL	PARAMETER	CONDITIONS	MIN.	TYP.	MAX.	UNIT
$V_{isol}$	R.M.S. isolation voltage from both terminals to external heatsink	$f = 50\text{-}60 \text{ Hz}$ ; sinusoidal waveform; R.H. $\leq 65\%$ ; clean and dustfree	-		2500	V
$C_{isol}$	Capacitance from both terminals to external heatsink	$f = 1 \text{ MHz}$	-	10	-	pF

## THERMAL RESISTANCES

SYMBOL	PARAMETER	CONDITIONS	MIN.	TYP.	MAX.	UNIT
$R_{th\ j\text{-}hs}$	Thermal resistance junction to heatsink	with heatsink compound	-	-	5.5	K/W
$R_{th\ j\text{-}a}$	Thermal resistance junction to ambient	without heatsink compound in free air	-	55	7.2	K/W

## STATIC CHARACTERISTICS

 $T_j = 25 \text{ }^\circ\text{C}$  unless otherwise stated

SYMBOL	PARAMETER	CONDITIONS	MIN.	TYP.	MAX.	UNIT
$V_F$	Forward voltage	$I_F = 8 \text{ A}$ ; $T_j = 150 \text{ }^\circ\text{C}$	-	0.80	0.895	V
		$I_F = 8 \text{ A}$	-	0.92	1.05	V
		$I_F = 20 \text{ A}$	-	1.1	1.3	V
$I_R$	Reverse current	$V_R = V_{RWM}$ ; $T_j = 100 \text{ }^\circ\text{C}$	-	0.2	0.6	mA
		$V_R = V_{RWM}$	-	2	10	$\mu\text{A}$

## DYNAMIC CHARACTERISTICS

 $T_j = 25 \text{ }^\circ\text{C}$  unless otherwise stated

SYMBOL	PARAMETER	CONDITIONS	MIN.	TYP.	MAX.	UNIT
$Q_s$	Reverse recovery charge	$I_F = 2 \text{ A}$ ; $V_R \geq 30 \text{ V}$ ; $-di_F/dt = 20 \text{ A}/\mu\text{s}$	-	4	11	nC
$t_{rr1}$	Reverse recovery time	$I_F = 1 \text{ A}$ ; $V_R \geq 30 \text{ V}$ ; $-di_F/dt = 100 \text{ A}/\mu\text{s}$	-	20	25	ns
$t_{rr2}$	Reverse recovery time	$I_F = 0.5 \text{ A}$ to $I_R = 1 \text{ A}$ ; $I_{rec} = 0.25 \text{ A}$	-	15	20	ns
$V_{fr}$	Forward recovery voltage	$I_F = 1 \text{ A}$ ; $di_F/dt = 10 \text{ A}/\mu\text{s}$	-	1	-	V

Rectifier diodes  
ultrafast, rugged

BYW29EX series

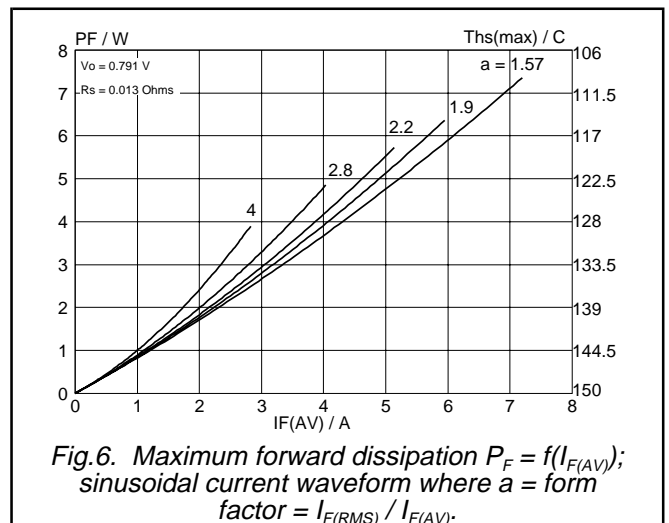
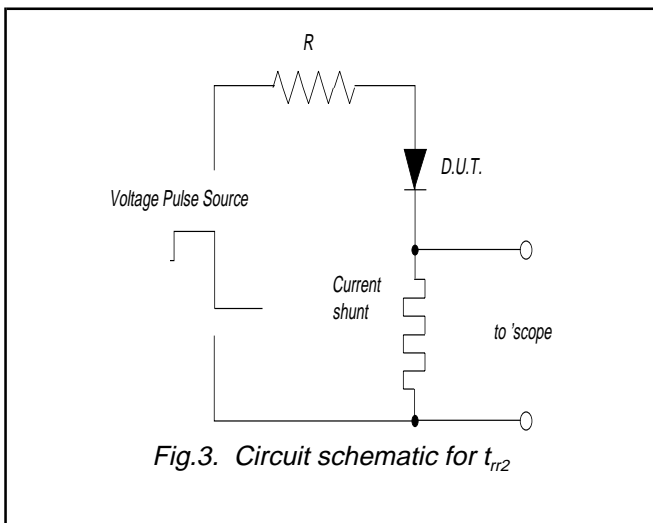
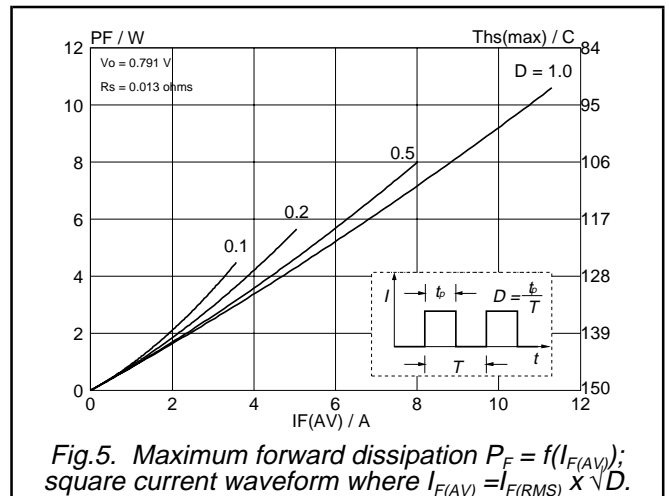
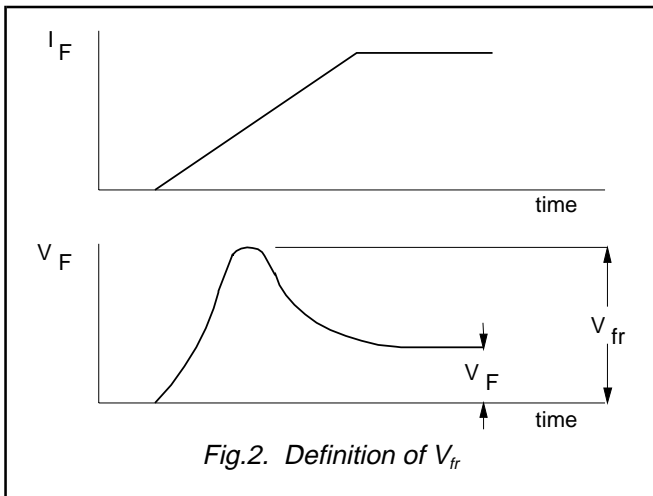
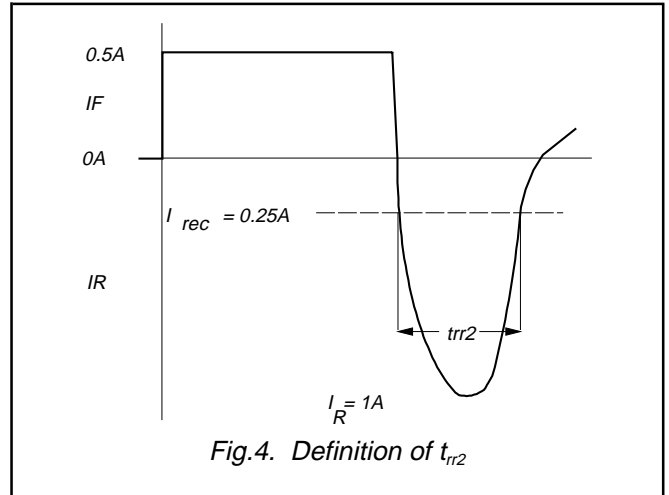
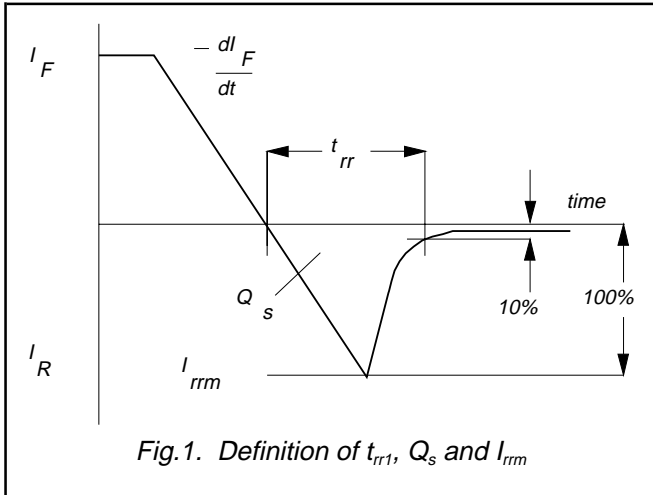

Rectifier diodes  
ultrafast, rugged

BYW29EX series

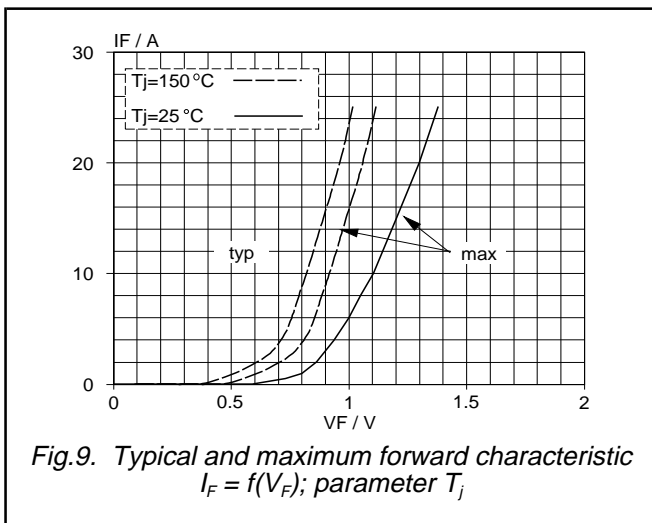
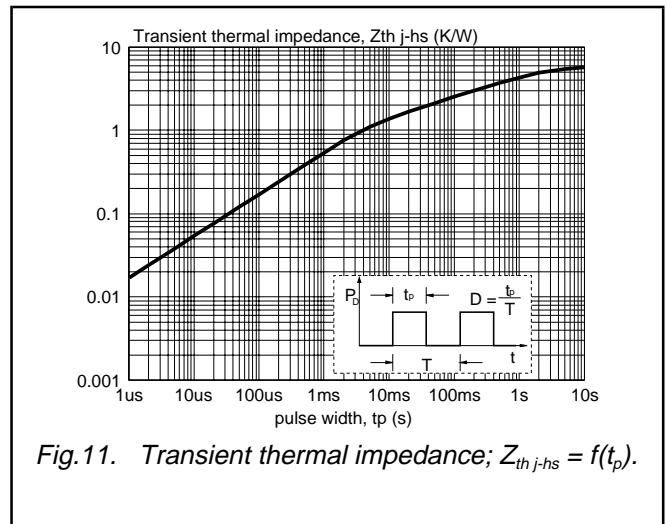
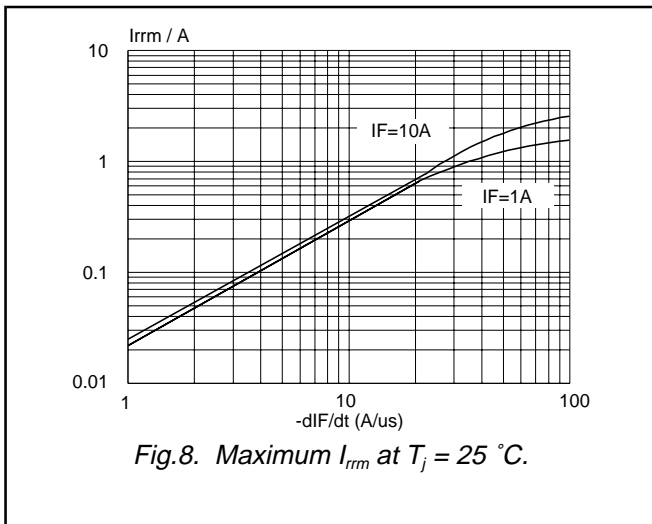
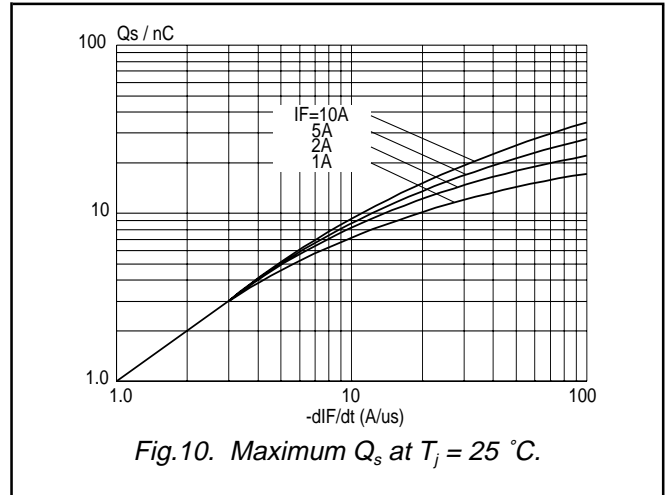
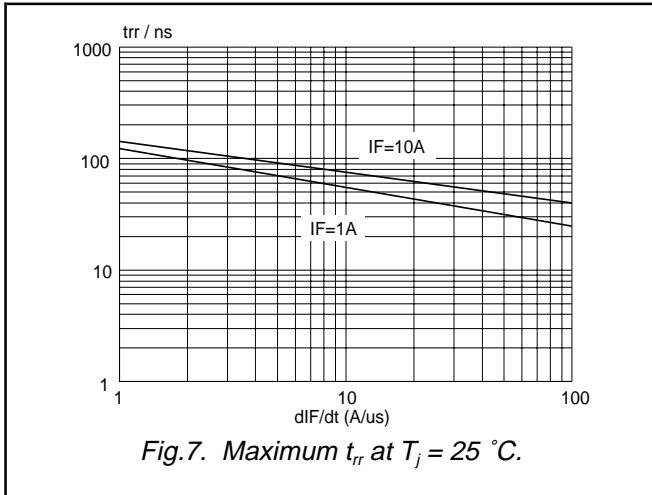

Rectifier diodes  
ultrafast, rugged

BYW29EX series

**MECHANICAL DATA**

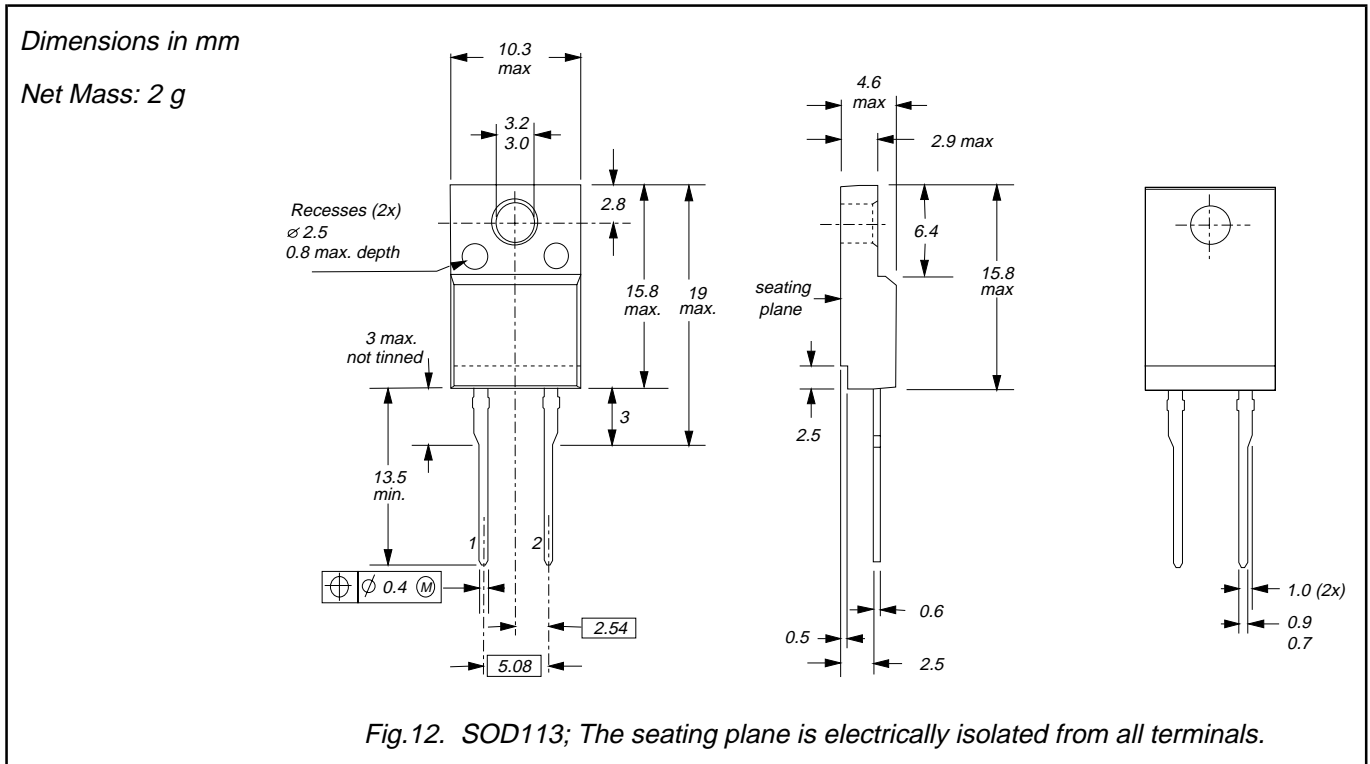

**Notes**

1. Refer to mounting instructions for F-pack envelopes.
2. Epoxy meets UL94 V0 at 1/8".

---

**Rectifier diodes  
ultrafast, rugged**

---

**BYW29EX series**

---

**DEFINITIONS**

<b>Data sheet status</b>	
Objective specification	This data sheet contains target or goal specifications for product development.
Preliminary specification	This data sheet contains preliminary data; supplementary data may be published later.
Product specification	This data sheet contains final product specifications.
<b>Limiting values</b>	
Limiting values are given in accordance with the Absolute Maximum Rating System (IEC 134). Stress above one or more of the limiting values may cause permanent damage to the device. These are stress ratings only and operation of the device at these or at any other conditions above those given in the Characteristics sections of this specification is not implied. Exposure to limiting values for extended periods may affect device reliability.	
<b>Application information</b>	
Where application information is given, it is advisory and does not form part of the specification.	
© Philips Electronics N.V. 1998	
All rights are reserved. Reproduction in whole or in part is prohibited without the prior written consent of the copyright owner.	
The information presented in this document does not form part of any quotation or contract, it is believed to be accurate and reliable and may be changed without notice. No liability will be accepted by the publisher for any consequence of its use. Publication thereof does not convey nor imply any license under patent or other industrial or intellectual property rights.	

**LIFE SUPPORT APPLICATIONS**

These products are not designed for use in life support appliances, devices or systems where malfunction of these products can be reasonably expected to result in personal injury. Philips customers using or selling these products for use in such applications do so at their own risk and agree to fully indemnify Philips for any damages resulting from such improper use or sale.