

**HIGH VOLTAGE FAST-SWITCHING  
NPN POWER TRANSISTOR**

- SGS-THOMSON PREFERRED SALESTYPES
- HIGH VOLTAGE CAPABILITY
- VERY HIGH SWITCHING SPEED

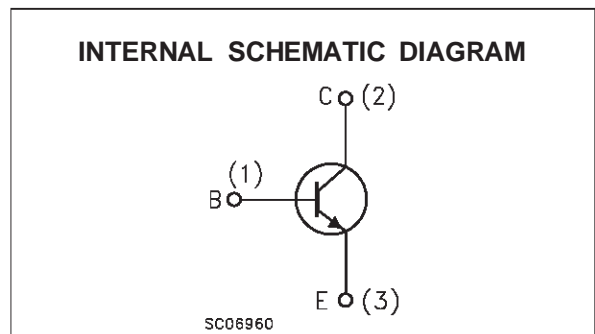
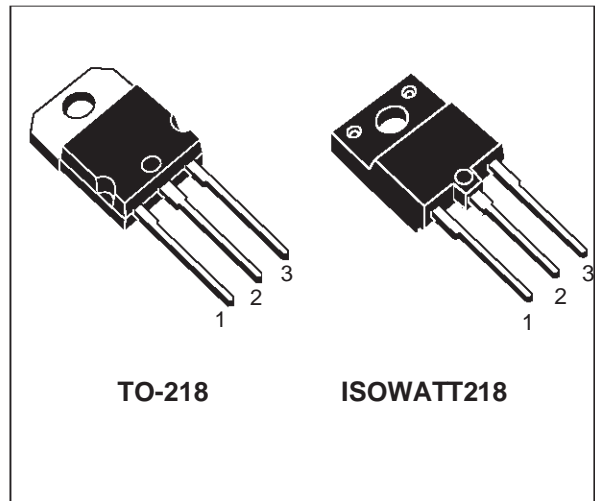
**APPLICATIONS:**

- HORIZONTAL DEFLECTION FOR COLOUR TV AND MONITORS

**DESCRIPTION**

The BUH1015 and BUH1015HI are manufactured using Multiepitaxial Mesa technology for cost-effective high performance and uses a Hollow Emitter structure to enhance switching speeds.

The BUH series is designed for use in horizontal deflection circuits in televisions and monitors.



**ABSOLUTE MAXIMUM RATINGS**

Symbol	Parameter	Value	Unit	
$V_{CBO}$	Collector-Base Voltage ( $I_E = 0$ )	1500	V	
$V_{CEO}$	Collector-Emitter Voltage ( $I_B = 0$ )	700	V	
$V_{EBO}$	Emitter-Base Voltage ( $I_C = 0$ )	10	V	
$I_C$	Collector Current	14	A	
$I_{CM}$	Collector Peak Current ( $t_p < 5$ ms)	18	A	
$I_B$	Base Current	8	A	
$I_{BM}$	Base Peak Current ( $t_p < 5$ ms)	11	A	
$P_{tot}$	Total Dissipation at $T_c = 25$ °C	160	70	W
$T_{stg}$	Storage Temperature	-65 to 150		°C
$T_j$	Max. Operating Junction Temperature	150		°C

# BUH1015/BUH1015HI

## THERMAL DATA

			TO-218	ISOWATT218	
$R_{thj-case}$	Thermal Resistance Junction-case	Max	0.78	1.8	$^{\circ}\text{C}/\text{W}$

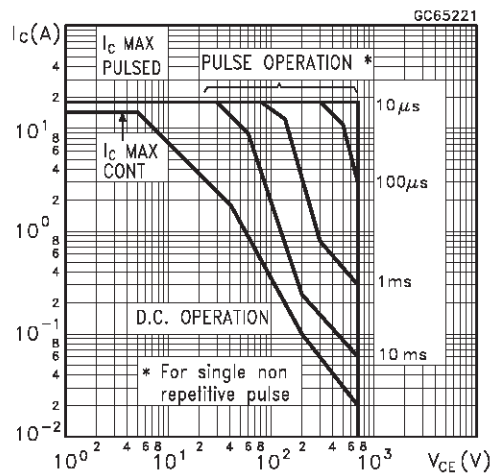
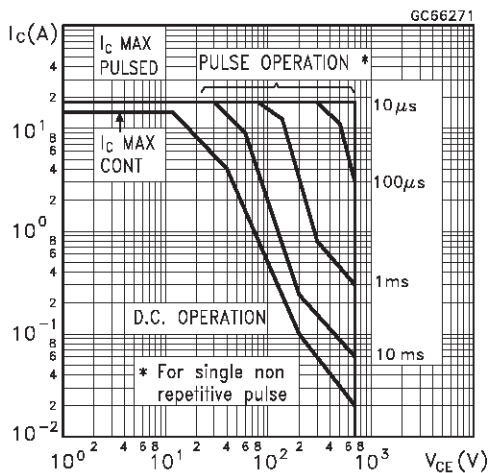
## ELECTRICAL CHARACTERISTICS ( $T_{case} = 25^{\circ}\text{C}$ unless otherwise specified)

Symbol	Parameter	Test Conditions	Min.	Typ.	Max.	Unit
$I_{CES}$	Collector Cut-off Current ( $V_{BE} = 0$ )	$V_{CE} = 1500\text{ V}$ $V_{CE} = 1500\text{ V}$ $T_j = 125^{\circ}\text{C}$			0.2 2	$\text{mA}$ $\text{mA}$
$I_{EBO}$	Emitter Cut-off Current ( $I_C = 0$ )	$V_{EB} = 5\text{ V}$			100	$\mu\text{A}$
$V_{CE(sus)}$	Collector-Emitter Sustaining Voltage	$I_C = 100\text{ mA}$	700			$\text{V}$
$V_{EBO}$	Emitter-Base Voltage ( $I_C = 0$ )	$I_E = 10\text{ mA}$	10			$\text{V}$
$V_{CE(sat)*}$	Collector-Emitter Saturation Voltage	$I_C = 10\text{ A}$ $I_B = 2\text{ A}$			1.5	$\text{V}$
$V_{BE(sat)*}$	Base-Emitter Saturation Voltage	$I_C = 10\text{ A}$ $I_B = 2\text{ A}$			1.5	$\text{V}$
$h_{FE*}$	DC Current Gain	$I_C = 10\text{ A}$ $V_{CE} = 5\text{ V}$ $I_C = 10\text{ A}$ $V_{CE} = 5\text{ V}$ $T_j = 100^{\circ}\text{C}$	7 5	10	14	
$t_s$ $t_f$	RESISTIVE LOAD Storage Time Fall Time	$V_{CC} = 400\text{ V}$ $I_C = 10\text{ A}$ $I_{B1} = 2\text{ A}$ $I_{B2} = -6\text{ A}$		1.5 110		$\mu\text{s}$ $\text{ns}$
$t_s$ $t_f$	INDUCTIVE LOAD Storage Time Fall Time	$I_C = 10\text{ A}$ $f = 31250\text{ Hz}$ $I_{B1} = 2\text{ A}$ $I_{B2} = -6\text{ A}$ $V_{ceflyback} = 1200 \sin\left(\frac{\pi}{5} 10^6\right) t \text{ V}$		4 220		$\mu\text{s}$ $\text{ns}$
$t_s$ $t_f$	INDUCTIVE LOAD Storage Time Fall Time	$I_C = 6\text{ A}$ $f = 64\text{ KHz}$ $I_{B1} = 1\text{ A}$ $V_{beoff} = -2\text{ V}$ $V_{ceflyback} = 1100 \sin\left(\frac{\pi}{5} 10^6\right) t \text{ V}$		3.7 200		$\mu\text{s}$ $\text{ns}$

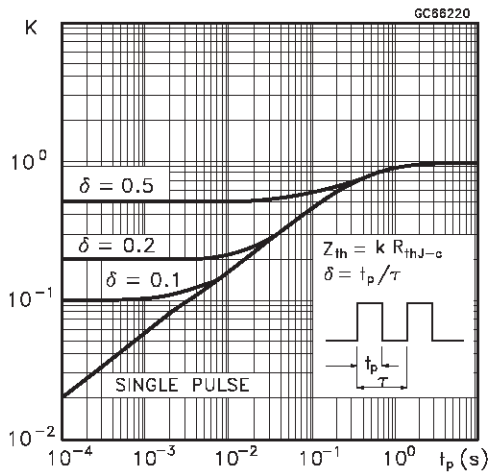
\* Pulsed: Pulse duration = 300  $\mu\text{s}$ , duty cycle 1.5 %

### Safe Operating Area For TO-218

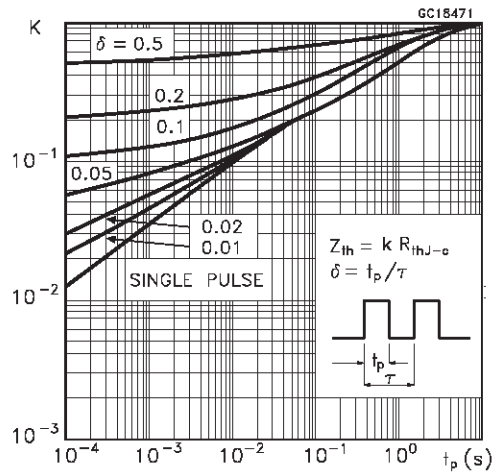
### Safe Operating Area For ISOWATT218



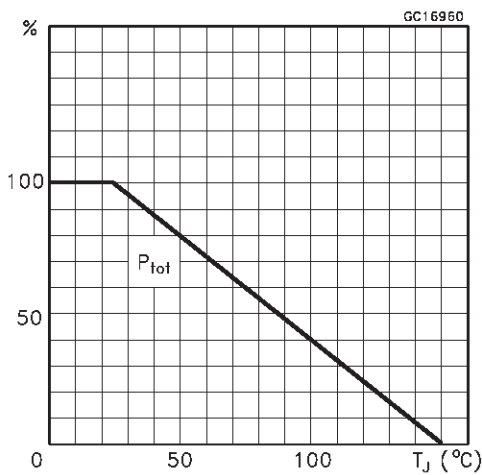
Thermal Impedance for TO-218



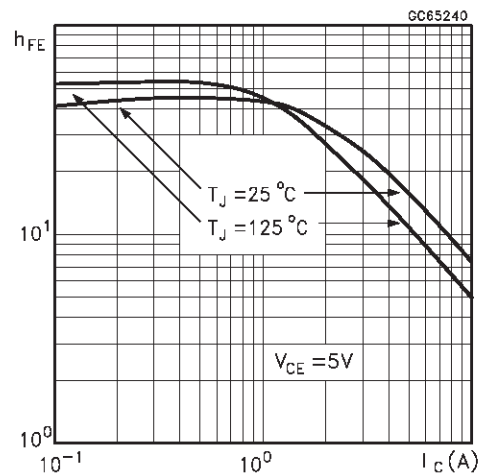
Thermal Impedance for ISOWATT218



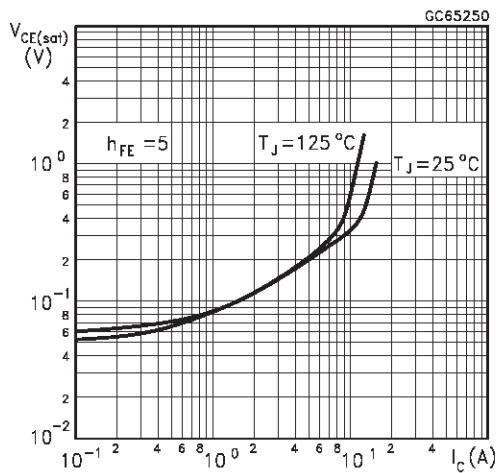
Derating Curve



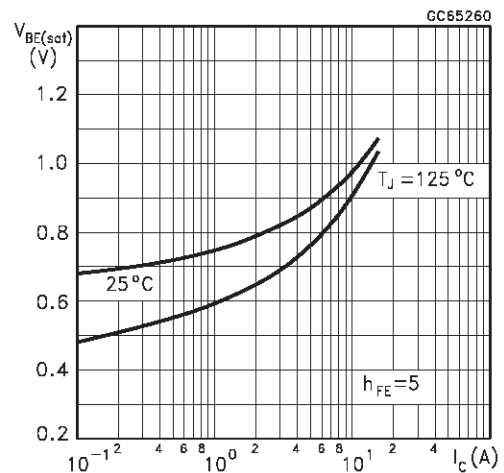
DC Current Gain



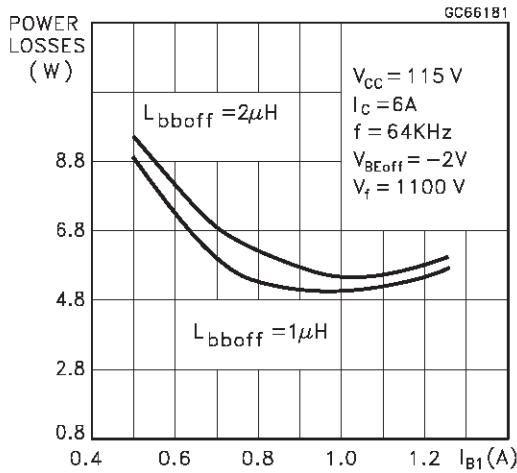
Collector Emitter Saturation Voltage



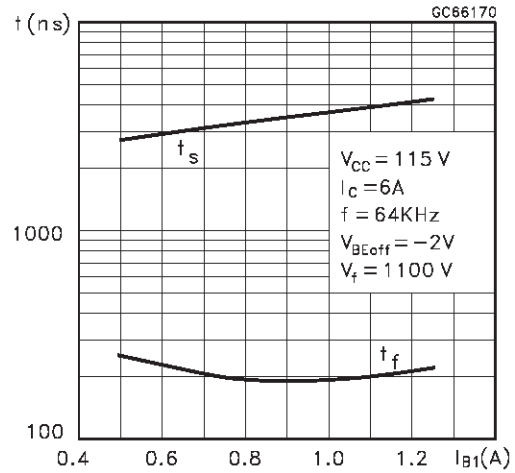
Base Emitter Saturation Voltage



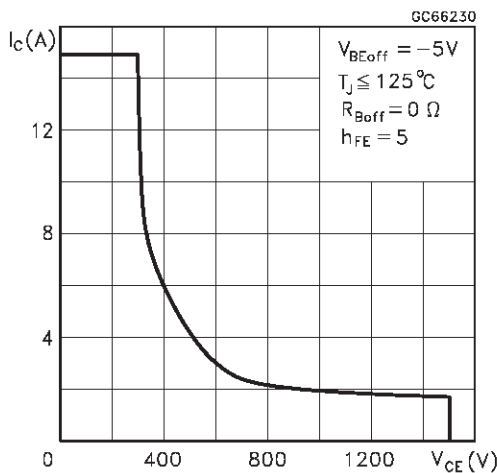
Power Losses at 64 KHz



Switching Time Inductive Load at 64KHz (see figure 2)



Reverse Biased SOA



BASE DRIVE INFORMATION

In order to saturate the power switch and reduce conduction losses, adequate direct base current  $I_{B1}$  has to be provided for the lowest gain  $h_{FE}$  at  $T_j = 100\text{ }^\circ\text{C}$  (line scan phase). On the other hand, negative base current  $I_{B2}$  must be provided the transistor to turn off (retrace phase). Most of the dissipation, especially in the deflection application, occurs at switch-off so it is essential to determine the value of  $I_{B2}$  which minimizes power losses, fall time  $t_f$  and, consequently,  $T_j$ . A new set of curves have been defined to give total power losses,  $t_s$  and  $t_f$  as a function of  $I_{B1}$  at 64 KHz scanning frequencies for choosing the

optimum drive. The test circuit is illustrated in figure 1.

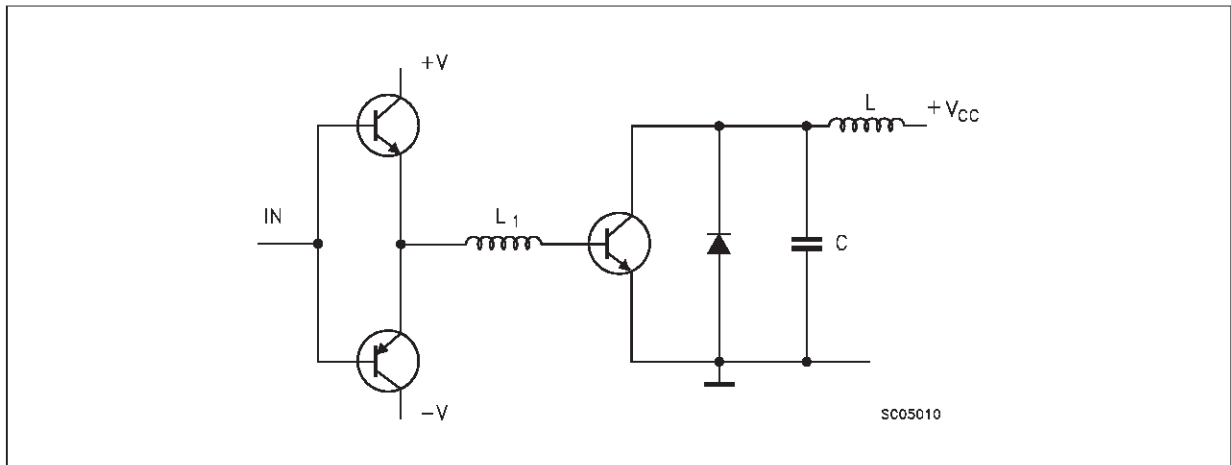
The values of L and C are calculated from the following equations:

$$\frac{1}{2} L (I_C)^2 = \frac{1}{2} C (V_{CEfly})^2$$

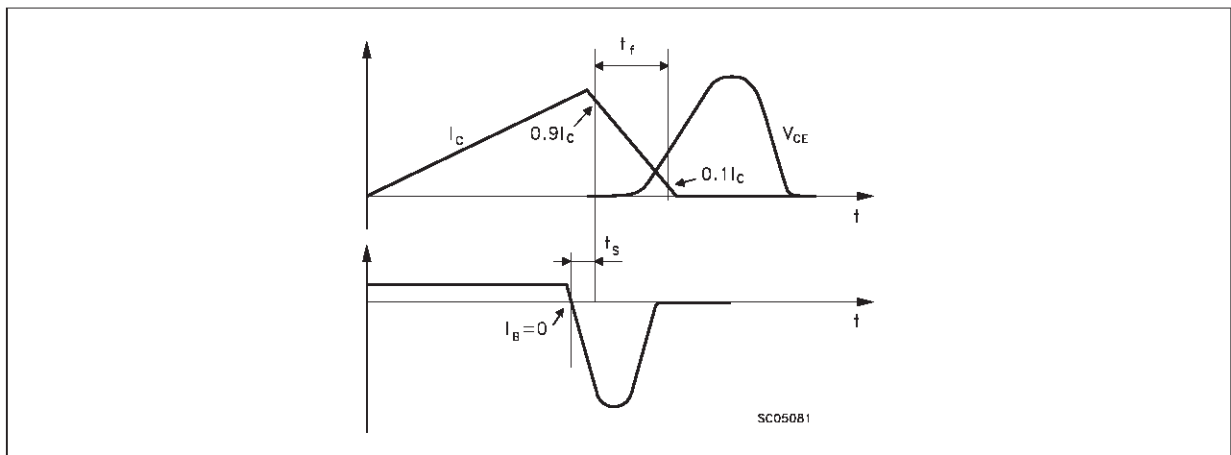
$$\omega = 2\pi f = \frac{1}{\sqrt{LC}}$$

Where  $I_C$ = operating collector current,  $V_{CEfly}$ = flyback voltage,  $f$ = frequency of oscillation during retrace.

**Figure 1:** Inductive Load Switching Test Circuits.

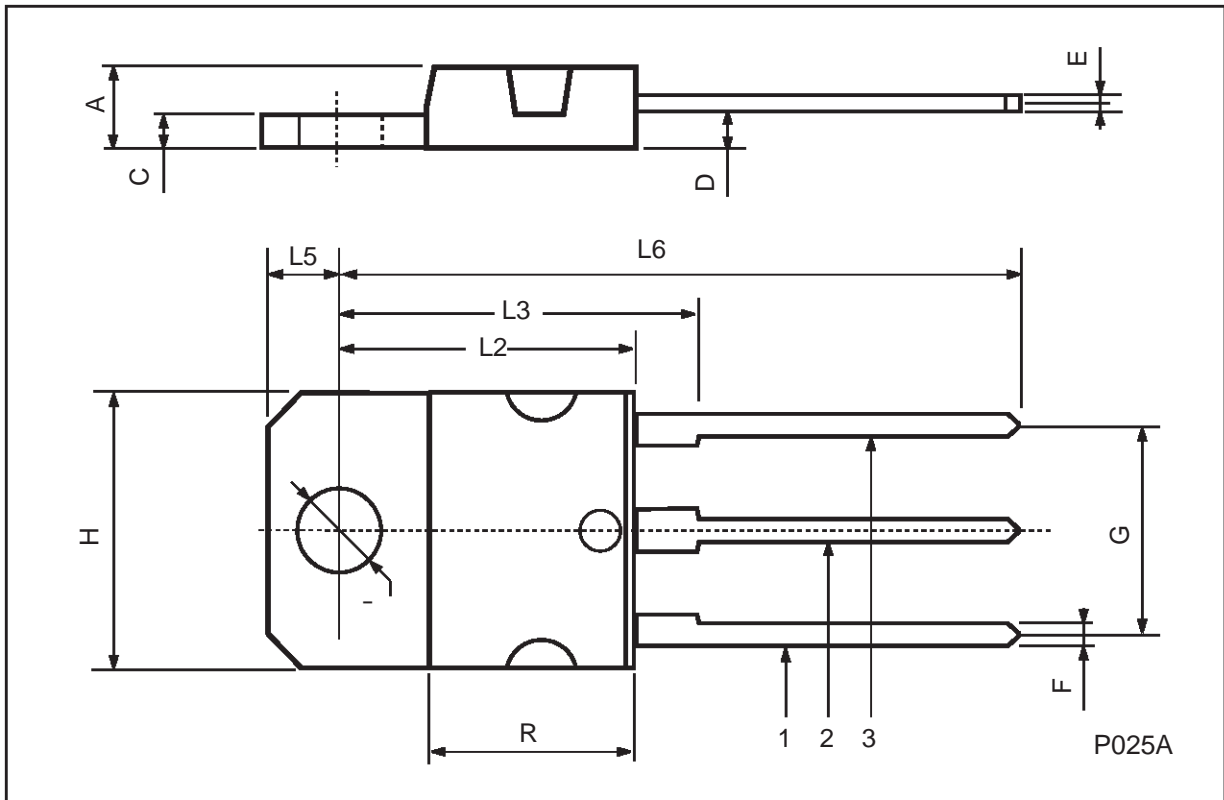


**Figure 2:** Switching Waveforms in a Deflection Circuit



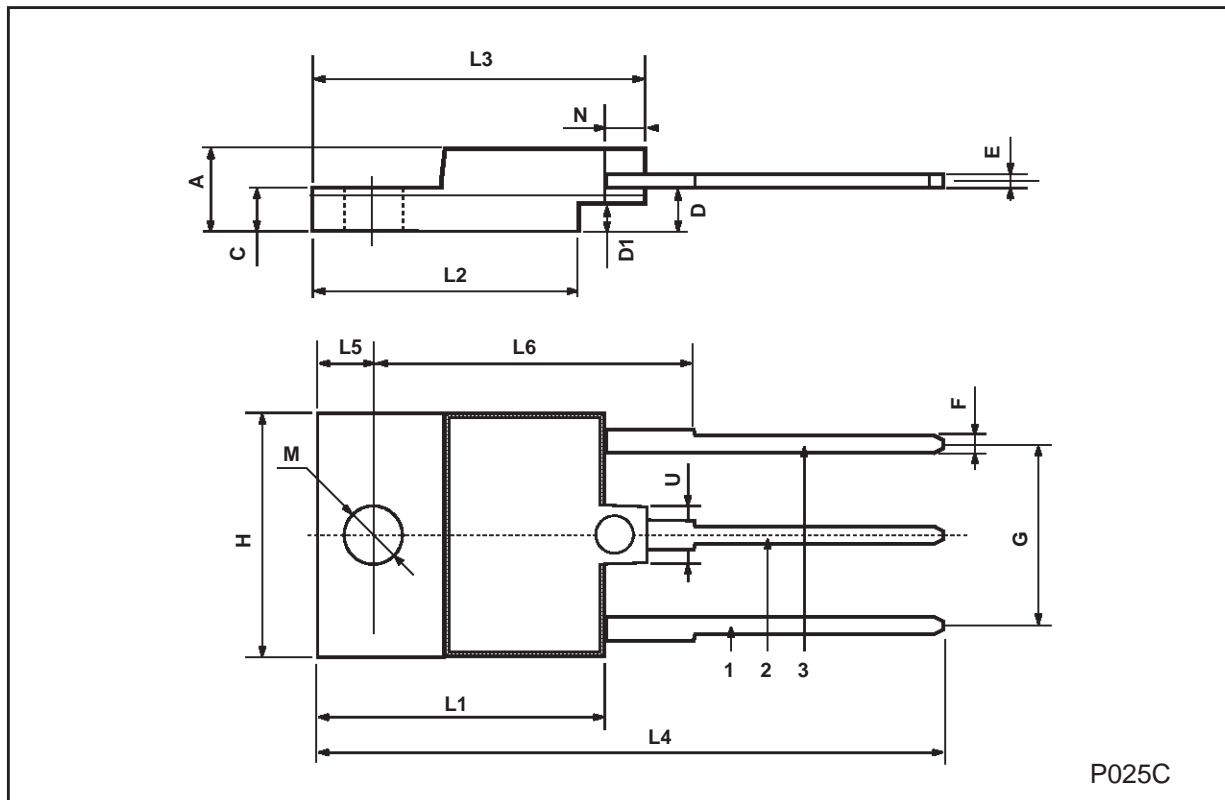
**TO-218 (SOT-93) MECHANICAL DATA**

DIM.	mm			inch		
	MIN.	TYP.	MAX.	MIN.	TYP.	MAX.
A	4.7		4.9	0.185		0.193
C	1.17		1.37	0.046		0.054
D		2.5			0.098	
E	0.5		0.78	0.019		0.030
F	1.1		1.3	0.043		0.051
G	10.8		11.1	0.425		0.437
H	14.7		15.2	0.578		0.598
L2	-		16.2	-		0.637
L3		18			0.708	
L5	3.95		4.15	0.155		0.163
L6		31			1.220	
R	-		12.2	-		0.480
Ø	4		4.1	0.157		0.161



ISOWATT218 MECHANICAL DATA

DIM.	mm			inch		
	MIN.	TYP.	MAX.	MIN.	TYP.	MAX.
A	5.35		5.65	0.210		0.222
C	3.3		3.8	0.130		0.149
D	2.9		3.1	0.114		0.122
D1	1.88		2.08	0.074		0.081
E	0.75		1	0.029		0.039
F	1.05		1.25	0.041		0.049
G	10.8		11.2	0.425		0.441
H	15.8		16.2	0.622		0.637
L1	20.8		21.2	0.818		0.834
L2	19.1		19.9	0.752		0.783
L3	22.8		23.6	0.897		0.929
L4	40.5		42.5	1.594		1.673
L5	4.85		5.25	0.190		0.206
L6	20.25		20.75	0.797		0.817
M	3.5		3.7	0.137		0.145
N	2.1		2.3	0.082		0.090
U		4.6			0.181	



Information furnished is believed to be accurate and reliable. However, SGS-THOMSON Microelectronics assumes no responsibility for the consequences of use of such information nor for any infringement of patents or other rights of third parties which may result from its use. No license is granted by implication or otherwise under any patent or patent rights of SGS-THOMSON Microelectronics. Specifications mentioned in this publication are subject to change without notice. This publication supersedes and replaces all information previously supplied. SGS-THOMSON Microelectronics products are not authorized for use as critical components in life support devices or systems without express written approval of SGS-THOMSON Microelectronics.

© 1998 SGS-THOMSON Microelectronics - Printed in Italy - All Rights Reserved

SGS-THOMSON Microelectronics GROUP OF COMPANIES  
Australia - Brazil - Canada - China - France - Germany - Italy - Japan - Korea - Malaysia - Malta - Morocco - The Netherlands -  
Singapore - Spain - Sweden - Switzerland - Taiwan - Thailand - United Kingdom - U.S.A