

HIGH VOLTAGE IGNITION COIL DRIVER NPN POWER DARLINGTON

- VERY RUGGED BIPOLAR TECHNOLOGY
- BUILT IN CLAMPING ZENER
- HIGH OPERATING JUNCTION TEMPERATURE
- WIDE RANGE OF PACKAGES

APPLICATIONS

- HIGH RUGGEDNESS ELECTRONIC IGNITIONS

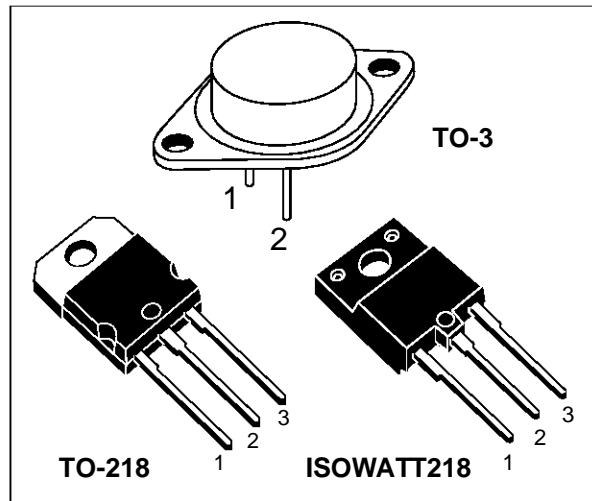

INTERNAL SCHEMATIC DIAGRAM

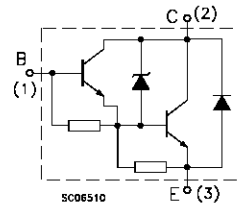

for TO-3
Emitter: pin 2
Base: pin 1
Collector: tab

ABSOLUTE MAXIMUM RATINGS

Symbol	Parameter	Value			Unit
		BU941Z	BU941ZP	BUB941ZPFI	
V_{CEO}	Collector-Emitter Voltage ($I_B = 0$)	350			V
V_{EBO}	Emitter-Base Voltage ($I_C = 0$)	5			V
I_C	Collector Current	15			A
I_{CM}	Collector Peak Current	30			A
I_B	Base Current	1			A
I_{BM}	Base Peak Current	5			A
P_{tot}	Total Dissipation at $T_c = 25^\circ\text{C}$	180	155	65	W
T_{stg}	Storage Temperature	-65 to 200	-65 to 175	-65 to 175	$^\circ\text{C}$
T_j	Max. Operating Junction Temperature	200	175	175	$^\circ\text{C}$

BU941Z/BU941ZP/BU941ZPFI

THERMAL DATA

		TO-3	TO-218	ISOWATT218	
$R_{thj-case}$	Thermal Resistance Junction-case Max	0.97	0.97	2.3	$^{\circ}C/W$

ELECTRICAL CHARACTERISTICS ($T_{case} = 25^{\circ}C$ unless otherwise specified)

Symbol	Parameter	Test Conditions	Min.	Typ.	Max.	Unit
I_{CEO}	Collector Cut-off Current ($I_B = 0$)	$V_{CE} = 300 V$ $V_{CE} = 300 V \quad T_j = 125^{\circ}C$			100 0.5	μA mA
I_{EBO}	Emitter Cut-off Current ($I_C = 0$)	$V_{EB} = 5 V$			20	mA
V_{CL}^*	Clamping Voltage	$I_C = 100 mA$	350		500	V
$V_{CE(sat)}^*$	Collector-Emitter Saturation Voltage	$I_C = 8 A \quad I_B = 100 mA$ $I_C = 10 A \quad I_B = 250 mA$ $I_C = 12 A \quad I_B = 300 mA$			1.8 1.8 2	V V V
$V_{BE(sat)}^*$	Base-Emitter Saturation Voltage	$I_C = 8 A \quad I_B = 100 mA$ $I_C = 10 A \quad I_B = 250 mA$ $I_C = 12 A \quad I_B = 300 mA$			2.2 2.5 2.7	V V V
h_{FE}^*	DC Current Gain	$I_C = 5 A \quad V_{CE} = 10 V$	300			
V_F	Diode Forward Voltage	$I_F = 10 A$			2.5	V
	Functional Test (see fig. 1)	$V_{CC} = 24 V \quad L = 7 mH$	10			A
t_s t_f	INDUCTIVE LOAD Storage Time Fall Time (see fig. 3)	$V_{CC} = 12 V \quad L = 7 mH \quad V_{clamp} = 300 V$ $I_C = 7 A \quad I_B = 70 mA$ $V_{BE} = 0 \quad R_{BE} = 47 \Omega$		15 0.5		μs μs

* Pulsed: Pulse duration = 300 μs , duty cycle 1.5 %

Safe Operating Area

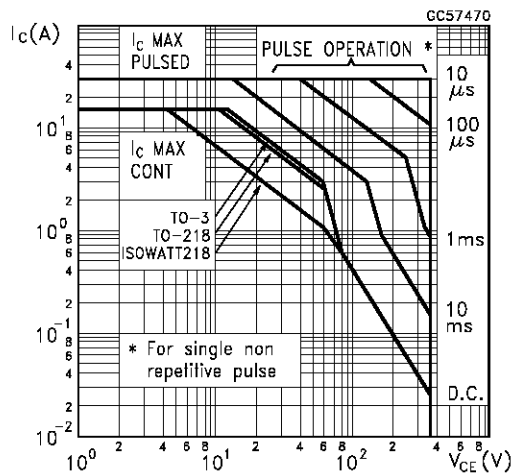

DC Current Gain

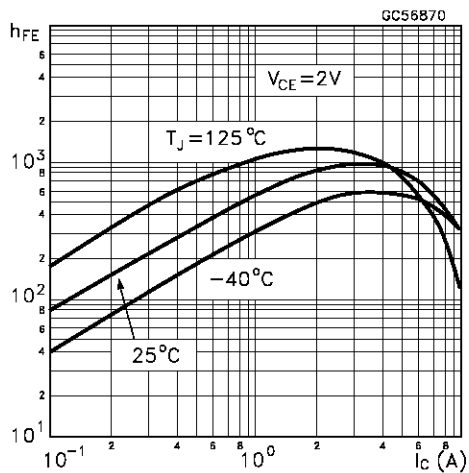

DC Current Gain

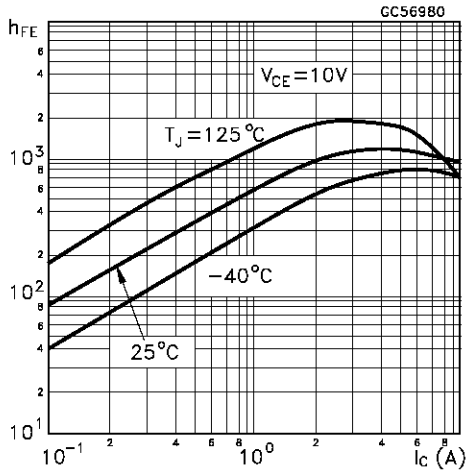

Collector-emitter Saturation Voltage

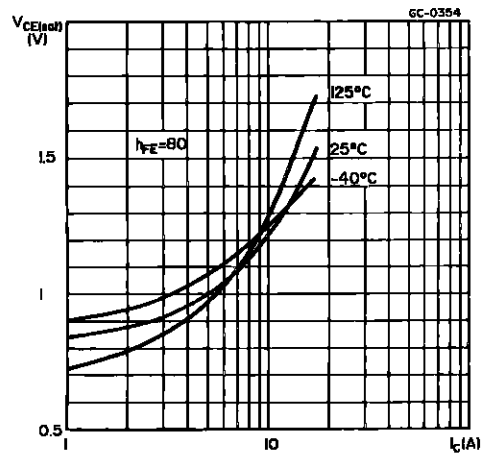

Collector-emitter Saturation Voltage

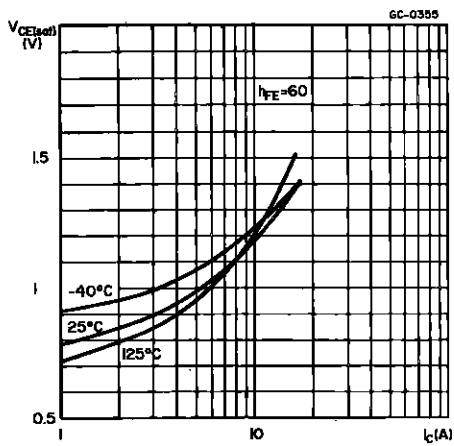

Base-emitter Saturation Voltage

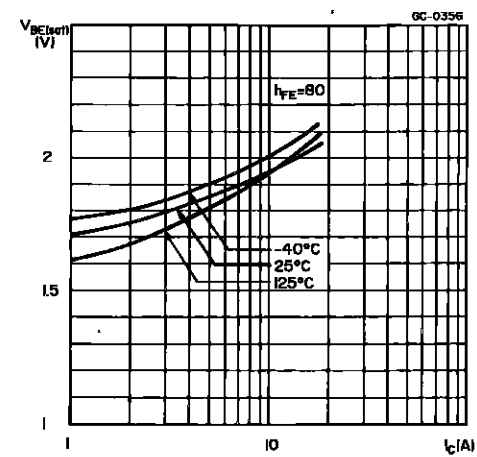

Base-emitter Saturation Voltage

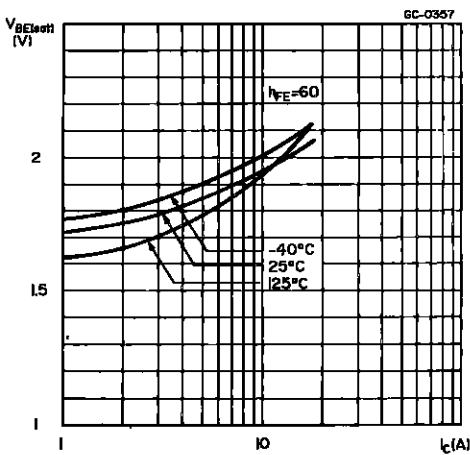

Collector-emitter Saturation Voltage

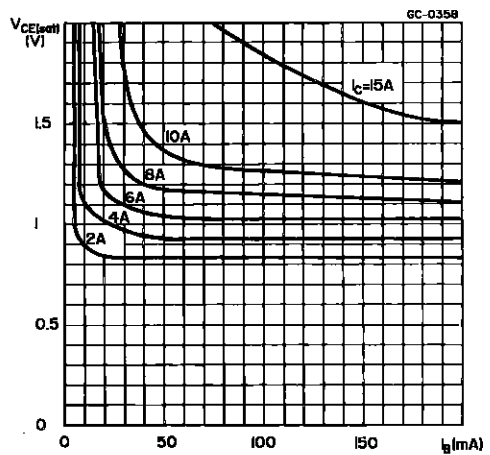

FIGURE 1: Functional Test Circuit

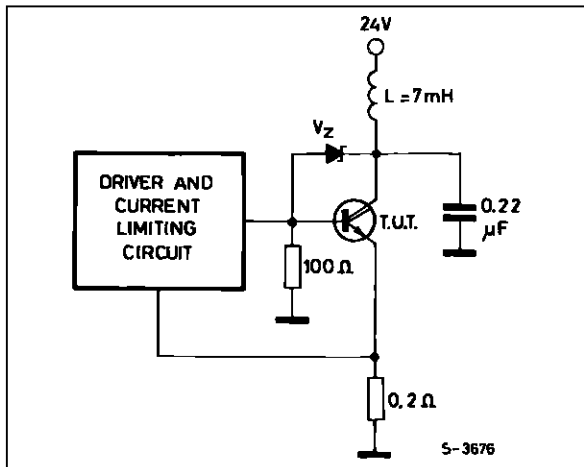

FIGURE 2: Functional Test Waveforms

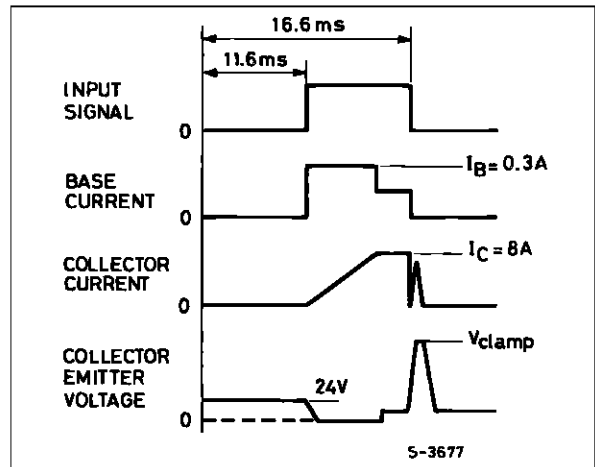
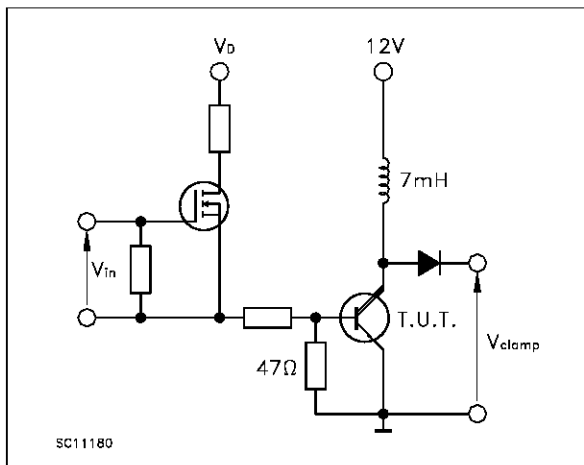
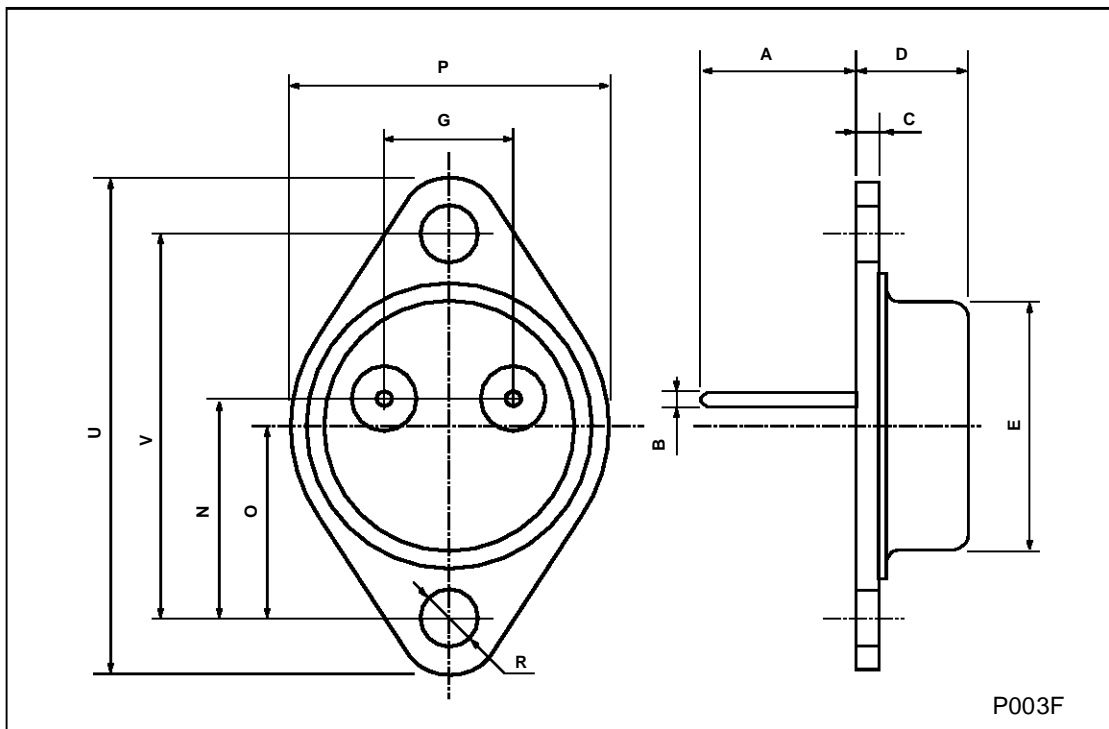

FIGURE 3: Switching Time Test Circuit



TO-3 MECHANICAL DATA

DIM.	mm			inch		
	MIN.	TYP.	MAX.	MIN.	TYP.	MAX.
A	11.00		13.10	0.433		0.516
B	0.97		1.15	0.038		0.045
C	1.50		1.65	0.059		0.065
D	8.32		8.92	0.327		0.351
E	19.00		20.00	0.748		0.787
G	10.70		11.10	0.421		0.437
N	16.50		17.20	0.649		0.677
P	25.00		26.00	0.984		1.023
R	4.00		4.09	0.157		0.161
U	38.50		39.30	1.515		1.547
V	30.00		30.30	1.187		1.193



TO-218 (SOT-93) MECHANICAL DATA

DIM.	mm			inch		
	MIN.	TYP.	MAX.	MIN.	TYP.	MAX.
A	4.7		4.9	0.185		0.193
C	1.17		1.37	0.046		0.054
D		2.5			0.098	
E	0.5		0.78	0.019		0.030
F	1.1		1.3	0.043		0.051
G	10.8		11.1	0.425		0.437
H	14.7		15.2	0.578		0.598
L2	-		16.2	-		0.637
L3		18			0.708	
L5	3.95		4.15	0.155		0.163
L6		31			1.220	
R	-		12.2	-		0.480
Ø	4		4.1	0.157		0.161

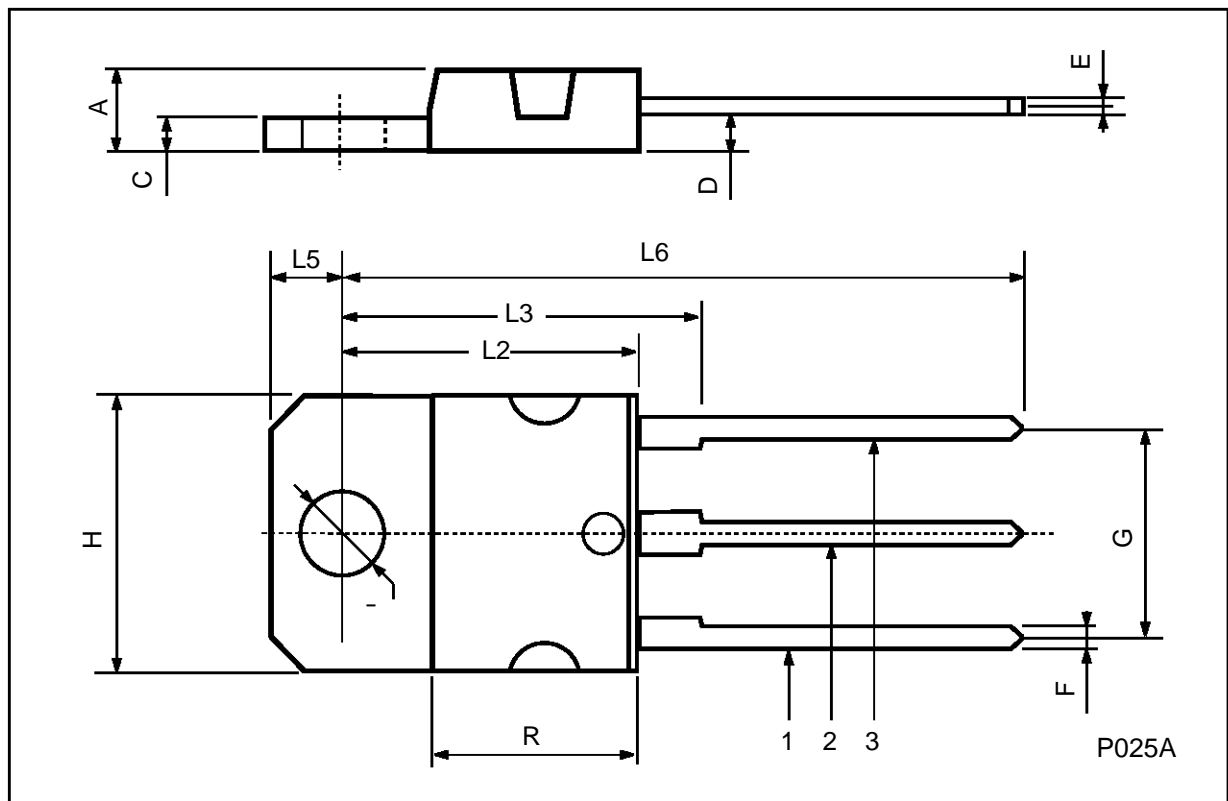

ISOWATT218 MECHANICAL DATA

DIM.	mm			inch		
	MIN.	TYP.	MAX.	MIN.	TYP.	MAX.
A	5.35		5.65	0.210		0.222
C	3.3		3.8	0.130		0.149
D	2.9		3.1	0.114		0.122
D1	1.88		2.08	0.074		0.081
E	0.75		1	0.029		0.039
F	1.05		1.25	0.041		0.049
G	10.8		11.2	0.425		0.441
H	15.8		16.2	0.622		0.637
L1	20.8		21.2	0.818		0.834
L2	19.1		19.9	0.752		0.783
L3	22.8		23.6	0.897		0.929
L4	40.5		42.5	1.594		1.673
L5	4.85		5.25	0.190		0.206
L6	20.25		20.75	0.797		0.817
M	3.5		3.7	0.137		0.145
N	2.1		2.3	0.082		0.090
U		4.6			0.181	

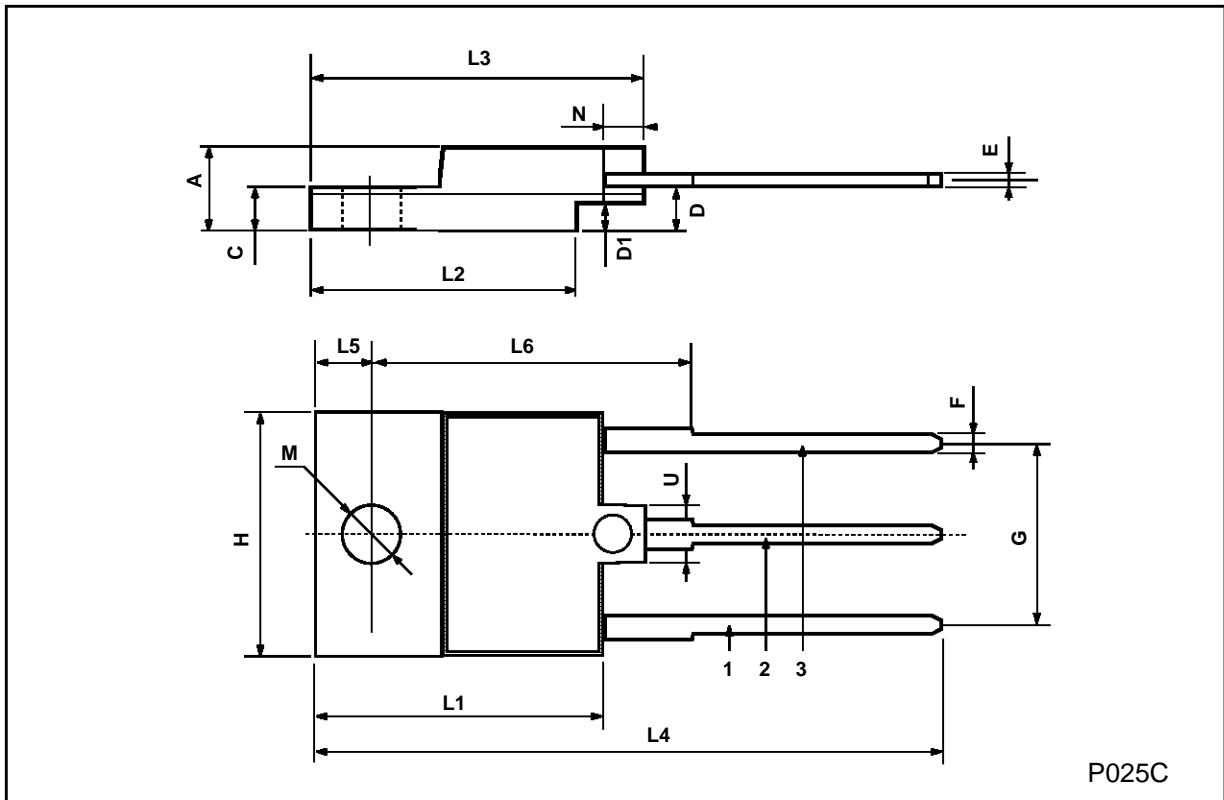

Information furnished is believed to be accurate and reliable. However, SGS-THOMSON Microelectronics assumes no responsibility for the consequences of use of such information nor for any infringement of patents or other rights of third parties which may result from its use. No license is granted by implication or otherwise under any patent or patent rights of SGS-THOMSON Microelectronics. Specifications mentioned in this publication are subject to change without notice. This publication supersedes and replaces all information previously supplied. SGS-THOMSON Microelectronics products are not authorized for use as critical components in life support devices or systems without express written approval of SGS-THOMSON Microelectronics.

© 1997 SGS-THOMSON Microelectronics - Printed in Italy - All Rights Reserved

SGS-THOMSON Microelectronics GROUP OF COMPANIES
Australia - Brazil - Canada - China - France - Germany - Hong Kong - Italy - Japan - Korea - Malaysia - Malta - Morocco - The Netherlands -
Singapore - Spain - Sweden - Switzerland - Taiwan - Thailand - United Kingdom - U.S.A
...