

Digital NTSC/PAL Encoder

BU1419K

The BU1419K is an LSI IC that converts digital YUV input into analog video signals in the NTSC or PAL format.

● Applications

Video CDs

● Features

- 1) Supported input clocks : 27.0/13.5MHz.
- 2) 16-bit input Y, U and V signals.
- 3) Supports both timing master and timing slave synchronization signals.
- 4) NTSC, PAL, Y and C signals are output through 3-channel, 9-bit high-speed DAC (with 75 Ω driver).
- 5) Internal 8-color OSD function.
- 6) Single 5V power supply.

● Absolute maximum ratings (Ta=25°C)

Parameter	Symbol	Limits	Unit
Power supply voltage	V _{DD} , AV _{DD} , DV _{DD}	-0.5~7.0	V
Input voltage	V _{IN}	-0.5~V _{DD} +0.5	V
Storage temperature	T _{stg}	-55~150	°C
Power dissipation	P _d	1375*1	mW

*1 Reduced by 11 mW for each increase in Ta of 1°C over 25°C.
When mounted to a 70 × 70 × 1.6 mm glass epoxy board

※ Does not represent guaranteed performance

© Not designed for radiation resistance.

● Recommended operating conditions

Parameter	Symbol	Limits	Unit
Power supply voltage	V _{DD} =AV _{DD} =DV _{DD} *	4.75~5.25	V
Input voltage, high level	V _{IH}	2.1~V _{DD}	V
Input voltage, low level	V _{IL}	0~0.8	V
Analog input voltage	V _{AIN}	0~AV _{DD}	V
Operating temperature	T _{opr}	-25~60	°C

* Use at V_{DD} = AV_{DD} = DV_{DD}

● Block diagram

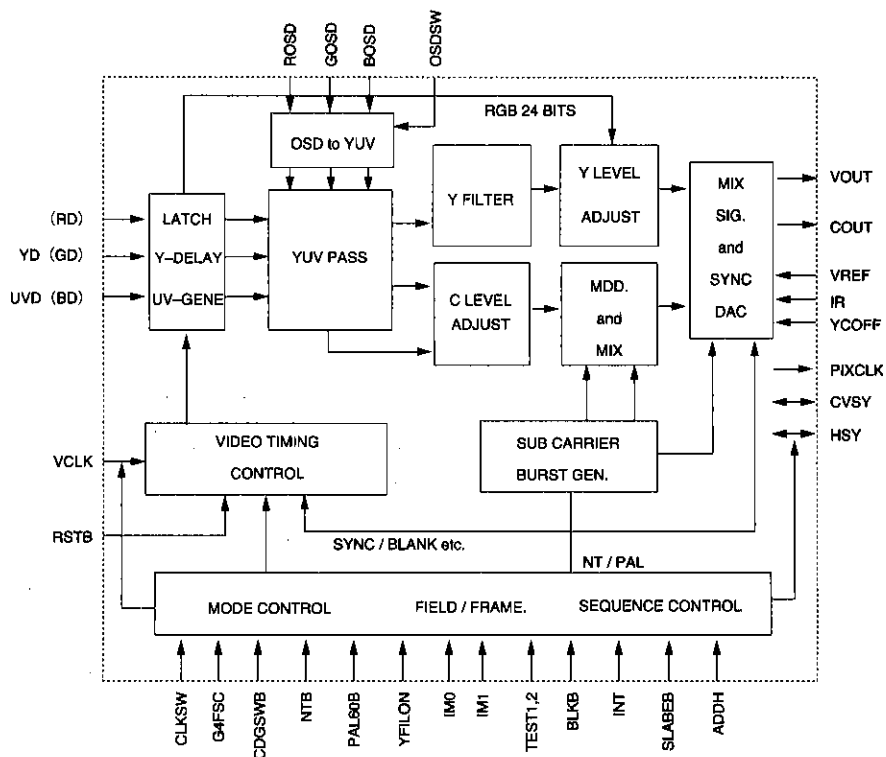

Digital NTSC/PAL encoders

Multimedia video

● Pin descriptions

Pin No.	Pin name	Function		Pin No.	Pin name	Function	
1	BOSD	OSD BLUE DATA INPUT	*	33	SLABEB	SET MODE MASTER/SLABE	*
2	YD0	Y DATA Bit0 (LSB)	*	34	ADDH	ADD ONE_LINE AT NON - INTER.	*
3	YD1	Y DATA Bit1	*	35	VREF	REFERENCE VOLTAGE (1.29V)	
4	YD2	Y DATA Bit2	*	36	CGND	CHROMA OUTPUT GROUND	
5	YD3	Y DATA Bit3	*	37	COU	CHROMA OUTPUT	
6	YD4	Y DATA Bit4		38	VGND	GROUND	
7	YD5	Y DATA Bit5		39	VOUT	NORMALLY PULLDOWN TO GND	
8	YD6	Y DATA Bit6		40	AVSS	ANALOG (DAC,VREF) GROUND	
9	GND	DIGITAL GROUND		41	NC	—	
10	YD7	Y DATA Bit7 (MSB)		42	IR	REFERENCE RESISTOR (1.2K)	
11	UVD0	UV DATA Bit0 (LSB)	*	43	AVDD	ANALOG (DAC,REF) VDD	
12	UVD1	UV DATA Bit1	*	44	YGND	LUMINANCE OUTPUT GROUND	
13	UVD2	UV DATA Bit2	*	45	YOUT	LUMINANCE OUTPUT	
14	UVD3	UV DATA Bit3	*	46	G4FSC	PULLDOWN TO GND	
15	OSDSW	OSD INPUT ENABLE	*	47	GCLK	NORMALLY PULLDOWN TO GND	
16	CDGSWB	NORMALLY PULLUP TO VDD		48	YCOFF	DAC (YOUT,COU) OFF	*
17	UVD4	UV DATA Bit4		49	YFILON	PULLDOWN TO GND	*
18	UVD5	UV DATA Bit5		50	PAL60B	PAL60 ON AT NTB=HIGH	◇
19	UVD6	UV DATA Bit6		51	VCLK	VIDEO CLOCK INPUT FOR Video - CD	
20	UVD7	UV DATA Bit7 (MSB)		52	RSTB	LOGIC PART INITIAL RESET	◇
21	GND	DIGITAL GROUND		53	CLKSW	DIVIDE INPUT CLK ENABLE	
22	NTB	SELECT NTSC/PAL MODE		54	RD0	NORMALLY PULLDOWN TO GND	*
23	IM0	INPUT MODE SET Bit0	*	55	RD1	NORMALLY PULLDOWN TO GND	*
24	IM1	INPUT MODE SET Bit1	*	56	RD2	NORMALLY PULLDOWN TO GND	*
25	TEST1	NORMALLY PULLDOWN TO GND	*	57	ROSD	OSD RED DATA INPUT	*
26	TEST2	NORMALLY PULLDOWN TO GND	*	58	RD3	NORMALLY PULLDOWN TO GND	*
27	CVSY	C - SYNC OR V - SYNC INPUT		59	RD4	NORMALLY PULLDOWN TO GND	*
28	HSY	H - SYNC INPUT		60	RD5	NORMALLY PULLDOWN TO GND	*
29	PIXCLK	1/2 FREQ. OF INTERNAL CL		61	VDD	DIGITAL VDD	
30	BLKB	DATA BLANKING ENABLE	*	62	RD6	NORMALLY PULLDOWN TO GND	*
31	VDD	DIGITAL VDD		63	RD7	NORMALLY PULLDOWN TO GND	*
32	INT	INTERLACE/NON - INTERLACE		64	GOSD	OSD GREEN DATA INPUT	*

* . . . Internal pull-down resistor

◇ . . . Internal pull-up resistor

●Input/output circuits

Pin No.	Pin name	In/output	Equivalent circuit	Pin description
2~8 10	YD[0 : 7]	Input		Y signal input during 16-bit YUV input.
11~14 17~20	UVD[0 : 7]	Input		U and V signal input during 16-bit YUV input.
54~56 58~60 62,63	RD[0 : 7]	Input		Normally connected to GND.
1 57 64 15	ROSD GOSD BOSD OSDSW	Input		For OSD data input when using the OSD function. When OSDSW is HIGH, inputs from ROSD, GOSD and BOSD have priority having priority over YUV.
16	CDGSWB	Input		Normally connected to V _{DD} .
22	NTB	Input		For switching between the NTSC mode (L level) and PAL mode (H level)
23 24	IM0 IM1	Input		Control pin for setting the input mode to YUV or DAC through.
28	HSY	Input and output		<p>The horizontal synchronization pin. Inputs (when SLABEB is at the low level) or outputs (SLABEB when is at the high level) the negative HSYNC signal.</p> <p>Also used for the synchronizing signal for halving the clock frequency from VCLK (when CLKSW = L).</p>

Digital NTSC/PAL encoders

Multimedia video

Pin No.	Pin name	In/output	Equivalent circuit	Pin description
27	CVSY	Input		Inputs the composite synchronization signal (CSYNC) or vertical synchronization signal (VSYNC) (when SLABEB is at the low level), or outputs the vertical synchronization signal (VSYNC) (when SLABEB is at the high level).
30	BLKB	Input		Setting this pin to the high level enables data output beginning with the line immediately following the one where equivalent pulse output ended (normally kept at the low level).
29	PIXCLK	Output		Output after the internal clock signal is halved. Data are received at the edge transformation point of this clock signal.
32	INT	Input		Used to switch between interlacing (H level) and non-interlacing (L level).
33	SLABEB	Input		Used to switch between the master mode (H level) and slave mode (L level).
34	ADDH	Input		Enabled in the non-interface mode; used to switch between -0.5 lines (low level) and +0.5 lines (high level) as the number of lines in each interlacing field.

Pin No.	Pin name	In/output	Equivalent circuit	Pin description
35	VREF	Input		The reference voltage that determines the DAC output amplitude (1 LSB output current). Impress 1.29 V for normal 1 V _{P-P} output.
37	COUT	Output		S pin chroma output CGND is the reference ground.
39	VOUT	Output		Normally connected to GND.
45	YOUT	Output		S pin luminance output YGND is the reference ground.
42	IR	Input		Used to connect the reference resistor that determines DAC output amplitude (1 LSB output current). The current in this pin controls the per-bit current.
48	YCOFF	Input		Input of the low power mode switching signal. AT HIGH, the outputs of YOUT and COUT are turned off.
47	GCLK	Input		Normally connected to GND.
51	VCLK	Input		For input of the reference clock signal.

Digital NTSC/PAL encoders

Multimedia video

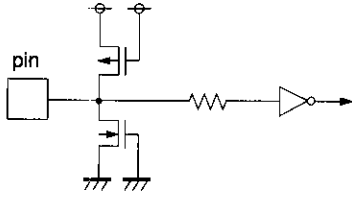
Pin No.	Pin name	In/output	Equivalent circuit	Pin description
52	RSTB	Input		For input of the reset signal that initializes the system
53	CLKSW	Input		Used to set the internal clock signal to one-half of VCLK input (low level) or equal to VCLK input (high level).
49 46	YFILON G4FSC	Input		Connect to GND.
50	PAL60B	Input		Used to switch between the PAL mode and PAL60 mode. Enabled when the NTB pin is at the high level.
25 26	TEST1 TEST2	Input		Should normally connect to GND.
31,61 43	VDD AVDD	—	—	Power supply pin for the digital and analog blocks.
9,21 36 38 40 44	GND CGND VGND AVSS YGND	—	—	Ground pin for the digital and analog blocks, composite output, luminance output and chroma output.

● Electrical characteristics (Unless otherwise noted, $T_a=25^\circ\text{C}$, $V_{DD}=AV_{DD}=DV_{DD}=5.0\text{V}$)

Parameter	Symbol	Min.	Typ.	Max.	Unit	Conditions
Clock frequency 1	fCLK1	—	27.0	—	MHz	Video - CD mode
Burst frequency 1	fBST1	—	3.5795	—	MHz	Subcarrier frequency (NTSC)
Burst frequency 2	fBST2	—	4.4336	—	MHz	Subcarrier frequency (PAL)
Burst cycle	CBST	—	9	—	CYC	
Operating circuit current	IDD	—	130.0	—	mA	* TBD
Output voltage, high level	VOH	4.0	4.5	—	V	IOH=−2.0mA
Output voltage, low level	VOL	—	0.5	1.0	V	IOH=2.0mA
Input voltage, high level	VIH	2.1	—	—	V	
Input voltage, low level	VIL	—	—	0.8	V	
Input current, high level	IIH	−10.0	0.0	10.0	μA	
Input current, low level	IIL	−10.0	0.0	10.0	μA	
DAC resolution	RES	—	9	—	BITS	
Linearity error	EL	—	±3.0	—	LSB	
Y white level current	IYW	—	25.14	—	mA	VREF=1.29V, RIR=1.2kΩ
Y black level current	IYB	—	7.24	—	mA	VREF=1.29V, RIR=1.2kΩ
Y zero level current	IYZ	−10.0	0.0	10.0	μA	

● Circuit operations

(1) General

The BU1419K converts 8-bit digital image data and video data to 9-bit luminosity signals (YOUT) and color signals (COUT) in the NTSC, PAL or PAL60 formats, and output.

Digital image and video data are adaptable for decoded video CD output. The output television signal can be switched to NTSC, PAL, PAL60, interlace or non-interlace. The clock signals input from VCLK can be used as the source clock for the internal clock. Input signals are received and processed in synchronization with the rise of the internal clock (BCLK, the base clock).

Input data is input from pins YD0 through YD7 and UVD0 through UVD7 in the YUV(4 : 2 : 2) format. Input format is selected with IM0 and IM1.

Enabling OSDSW validates input data from ROSD, GOSD and OSD, allowing for the input of 7-color (8 including black) data. As a clock frequency equal to 1/2 of the internal clock frequency is simultaneously output from PIXCLK, an OSD IC can be synchronized with

the BU1419K by connecting its clock input pin to PIXCLK.

The scanned data is adjusted to the 1001RE level at NTSC, PAL, and PAL60, after which U and V data are phase-modulated by an internally ordered subcarrier (3.58MHz in the NTSC mode and 4.43MHz in the PAL or PAL60 mode), generating modulated color signals. Finally, the needed synchronization levels, color blank level and burst signals, etc., are mixed, and NTSC and PAL luminance signals, and color signals are output through the 9-bit DAC.

Luminance signal (Y) : YOUT

Color signal (C) : COUT

When the video input pin (75 Ω termination) is connected, the luminance component of DAC output has a roughly 1.0 Vpp output range at the white level. For details concerning DAC output voltage levels, refer to Section 5, "DAC output level adjustment."

As the YOUT and COUT DAC output pins can be turned off by setting YCOFF to HIGH, the BU1419K allows for a low power mode.

Table 1. YCOFF pin low power consumption

Pin No.	Pin	Output mode and power consumption (* 1)		
		YOUT	COUT	Power consumption (Typ.)
48	YCOFF			
	LOW	Luminance signal	Chroma signal	0.65W
	HIGH	No output (0V)	No output (0V)	0.35W

* 1 AVDD=5.0V

(2) Mode setting

1) Output mode

Digital image and video data can be adapted for the Video-CD modes, which are selected according to the CDGSWB input voltage. The CD-G mode is selected when CDGSWB input is at the low level, the video CD mode when CDGSWB input is at the high level. Avail-

able output television modes are NTSC, PAL and PAL60, which are selected according to the inputs of NTB and PAL60 : The mode settings are given in the table below.

Table 2-1-1 : Mode setting

NTB	PAL60	TV mode
0	*	NTSC
1	0	PAL60
1	1	PAL

Also, output is switched between interlaced output and non-interlaced output according to the input of INT : Non-interlaced output is selected when INT is at the low level, interlaced output when INT is at the high level. During non-interlaced output, the per-field line

count can be controlled with ADDH : A per-field line count for interlaced output of -0.5 lines is selected when ADDH is at the low level, and a per-field line count for interlaced output of $+0.5$ lines when ADDH is at the high level.

Table 2-1-2 : Interlaced / non-interlaced mode setting

INT	ADDH	Scanning mode	Line count per field	
			NTSC / PAL60	PAL
0	0	Non-interlaced	262	312
0	1	Non-interlaced	263	313
1	*	Interlaced	262.5	312.5

In addition, BLKB is used to control data output that follows immediately after the end of the equivalent pulse : Data output immediately after the end of the equivalent pulse is prohibited when BLKB is at the low level, and enabled when BLKB is at the high level. Thus, this IC supports closed-caption and teletext broadcasting.

2) Input format

The input format for digital data is set with IM1 and IM0 as shown in the table below. In addition to YUV (4 : 2 : 2), input in digital RGB and analog RGB is also possible (in the RGB through mode).

Table 2-2-1 : Input format setting

IM1	IM0	Input format	Output signal
0	0	Not used with this IC.	—
0	1	YUV (4:2:2) video CD format	Television signal (9-bit resolution)
1	1	ROSD, GOSD and BOSD expanded in the RGB input.	RGB analog signal (9 bits)

See Table 2-2-2 below for pins and bit allocation in the through mode.

Table 2-2-2 : Bit allocation in the through mode

Output pin	BIT8	BIT7	BIT6	BIT5	BIT4	BIT3	BIT2	BIT1	BIT0
VOUT (39)	RD7	RD6	RD5	RD4	RD3	RD2	RD1	RD0	ROSD
YOUT (45)	GD7	GD6	GD5	GD4	GD3	GD2	GD1	GD0	GOSD
COU (37)	BD7	BD6	BD5	BD4	BD3	BD2	BD1	BD0	BOSD

The BU1419K also has internal OSD switches and a color data generation function, simplifying combined use with an OSD IC that outputs blank and RGB signals. Because the BU1419K outputs a clock frequency equal to 1/2 of the internal processing frequency, an OSD IC can be synchronized by connecting its clock

input to this output. Inputs to ROSD, GOSD and BOSD are valid while OSDSW is at the HIGH level. The relationship between OSD data and color data output is shown in Table 2-2-3 below.

Table 2-2-3 : OSD function : Input data / color output correlation

OSDSW	ROSD	GOSD	BOSD	Output color signal
1	0	0	0	Block (blanking)
1	0	0	1	Blue
1	0	1	0	Green
1	0	1	1	Cyan
1	1	0	0	Red
1	1	0	1	Magenta
1	1	1	0	Yellow
1	1	1	1	White
0	*	*	*	Depends on input set with IM0 and IM1

3) Clock

Generally, the externally supplied clock frequency should be double the internal clock frequency (BCLK, base clock) (when CLKSW is at the low level). The phase relationship between the internal and external clock signals is like that shown in Fig. 2-3-1 below, with HYS input as the reference. In the master mode, in

which HSY is used for output, HSY output is timed as shown in Fig. 2-3-1 below. The BU1419K receives data (YD and UVD) at the rise of the internal clock (BCLK), and so data should be input as shown in the figure below.

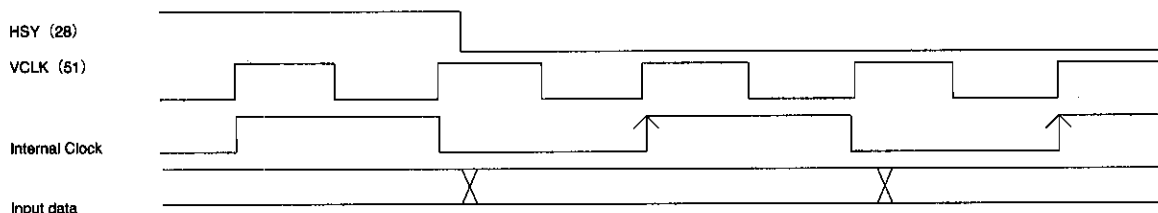

Fig. 2-3-1 Clock timing (CLKSW is at the low level)

Digital NTSC/PAL encoders

Multimedia video

An external clock frequency can be used as the internal clock frequency (BCLK) without modification by setting CLKSW to the high level. Data (YD and YUD)

are also received with the rise of BCLK, and so data should be input as shown in Fig. 2-3-2 below, which also shows the relationship with HSY.

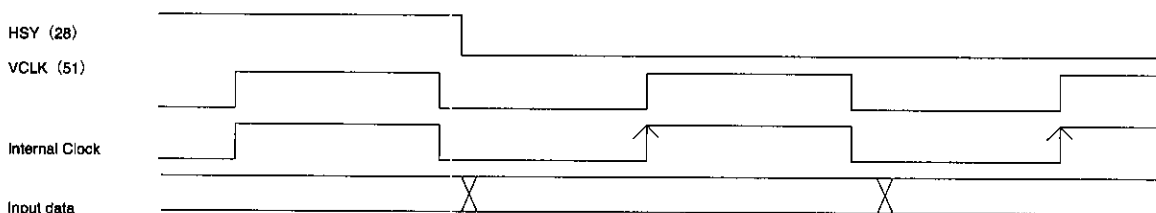

Fig. 2-3-2 Clock timing (CLKSW is at the high level)

The BU1419K generates a subcarrier (burst) frequency according to the input clock frequency. This limits the frequency used in each mode, and so data should be input at the frequencies shown below (Table 2-3-2).

Table 2-3-2 : Clock input frequencies (BU1419K)

CLKSW	Video CD mode
Pin	NTSC/PAL/PAL60 (common)
0	27.000MHz
1	13.500MHz

4) Synchronization signals

The BU1419K has two synchronization signal modes : the master mode, in which the synchronization signal is output, and the slave mode, in which the IC is synchronized to a synchronization signal input externally. The mode is selected with SLABEB : The slave mode is selected when SLABEB is at the low level, the master mode when SLABEB is at the high level.

In the master mode, signals are output from HSY and CVSY : the horizontal synchronization signal (HSYNC) from HSY and the vertical synchronization signal (VSYNC) from CVSY. In this mode, synchronization signal output is timed to the rise of RSTB, generating output according to the selected format (NTSC, PAL, PAL60, interlaced or non-interlaced).

In the slave mode, signals are input to HSY and CVSY : the horizontal synchronization signal (HSYNC) to HSY and the vertical synchronization signal VSYNC or a composite synchronization signal to CVSY. The IC automatically determines whether the input synchronization signal is VSYNC or CSYNC. Select the right input synchronization signal for the mode that has been set. After termination of RSTB, input odd and even numbers alternately. When input in a random odd and even sequence, output is blanked, after which normal data are output beginning with the next odd condition. The BU1419K is designed to handle only negative synchronization signals (i.e., those that result in the low level during the sink).

(3) Output level

Figures 1 through 6 below show pin output voltage level and the digital values of DAC output.

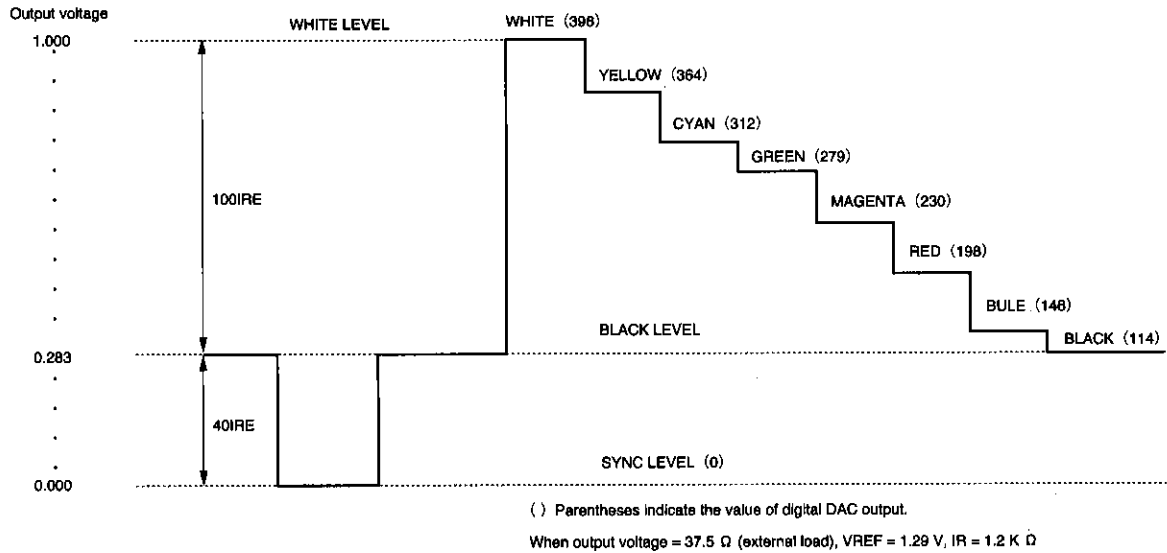

Fig. 1 NTSC Y (luminosity) signal output level

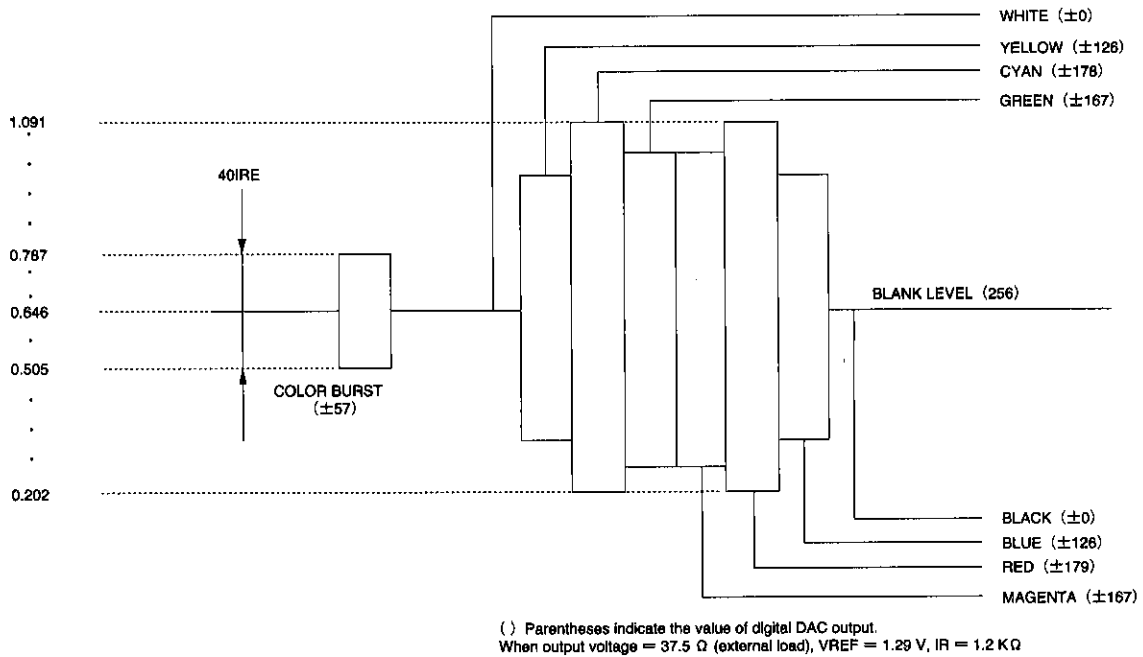
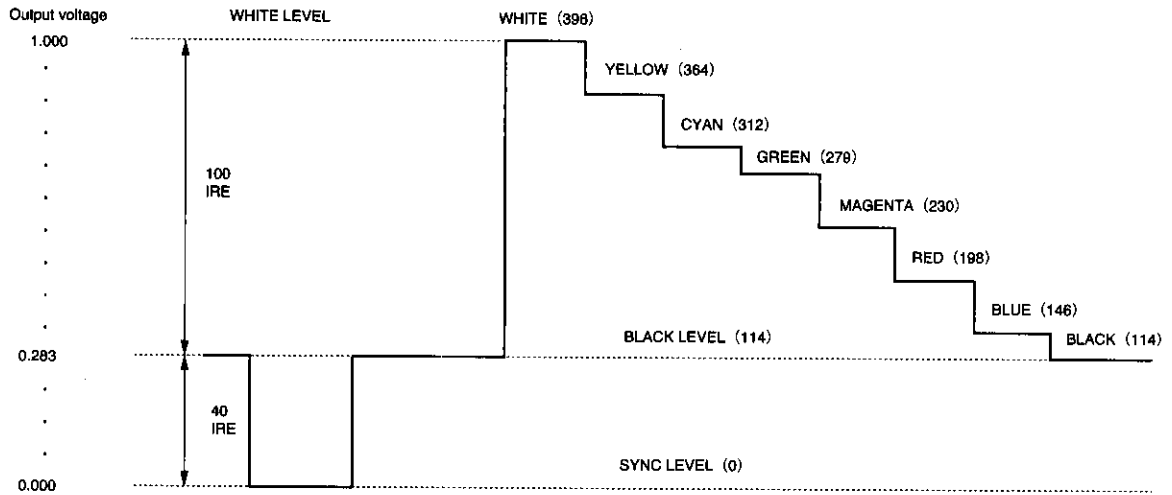

Fig. 2 NTSC C (chroma) signal output level

Digital NTSC/PAL encoders

Multimedia video



() Parentheses indicate the value of digital DAC output.
 When output voltage = 37.5 Ω (external load), VREF = 1.29 V, IR = 1.2 K Ω

Fig. 3 PAL/PAL60 Y (luminosity) signal output level

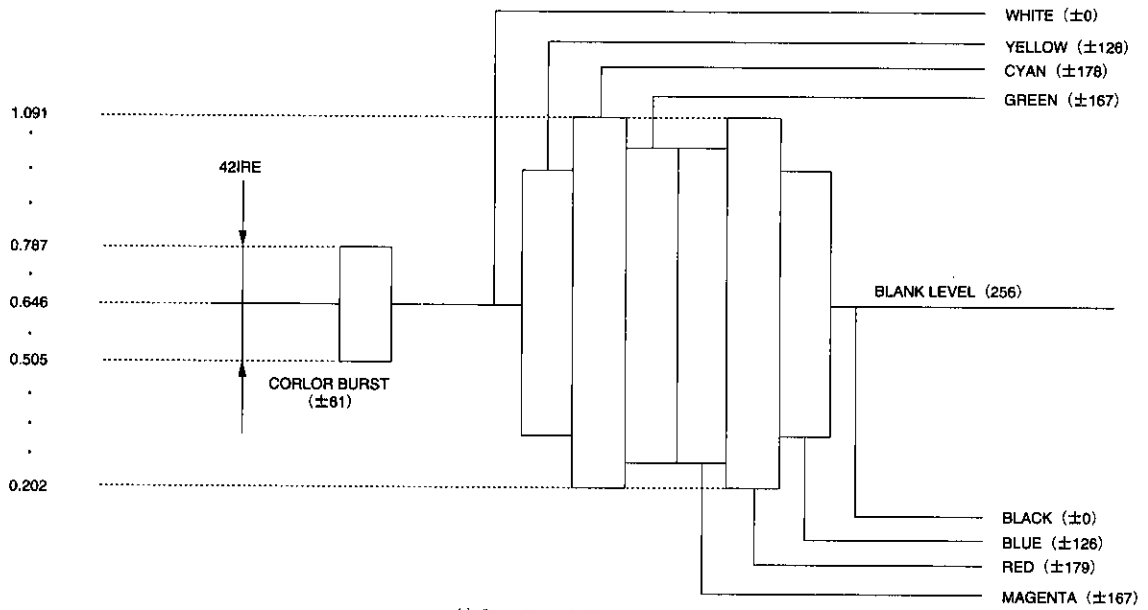

() Parentheses indicate the value of digital DAC output.
 When output voltage = 37.5 Ω (external load), VREF = 1.29 V, IR = 1.2 K Ω

Fig. 4 PAL/PAL60 C (chroma) signal output level

(4) Timing

The BU1419K is a digital encoder that outputs television signals in the NTSC, PAL or PAL60 format according to the inputs and outputs of VCLK, HSY and VSY. The timing input and output pins are shown in Table 4-1 below.

Table 4-1 : Timing input and output (BU1419K)

No	Pin	Name	Input/output	Function
1	52	RSTB	Input	System reset input
3	51	VCLK	Input	Clock input
4	53	CLKSW	Input	Clock input mode setting
5	27	CVSY	Input and output	Vertical and composite synchronization signal input and output
6	28	HSY	Input and output	Horizontal synchronization signal input and output
8	22	NTB	Input	Switching between the NTSC and PAL modes
9	50	PAL60B	Input	Switching between the PAL and PAL60 modes
10	30	BLKB	Input	Enabling data output immediately after the equivalent pulse (9H)
11	32	INT	Input	Switching between the interlaced and non-interlaced modes
12	33	SLABEB	Input	Switching between the master and slave modes
13	34	ADDH	Input	Adding 1 line in the non-interlaced mode

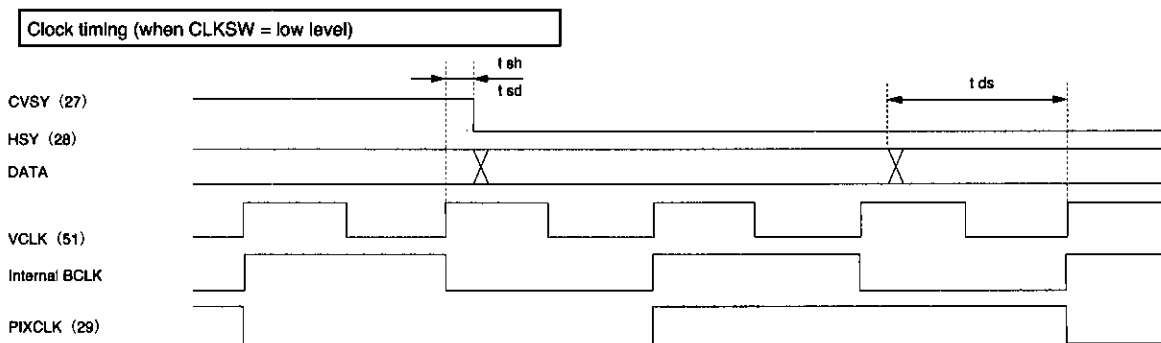

Fig. 5 Clock timing and data input timing

Parameter	Symbol	Unit	Min.	Typ.	Max.
SYNC input hold time	t sh	nS	—	10.0	—
SYNC output delay time	t sd	nS	—	20.0	—
Data setup time	t ds	nS	—	15.0	—

In the slave mode, inputs to HSY and CVSY should be timed according to the timing for HSY (Fig. 5). In the master mode, synchronization signal output is output from HSY and CVSY according to the timing as shown in Fig. 5.

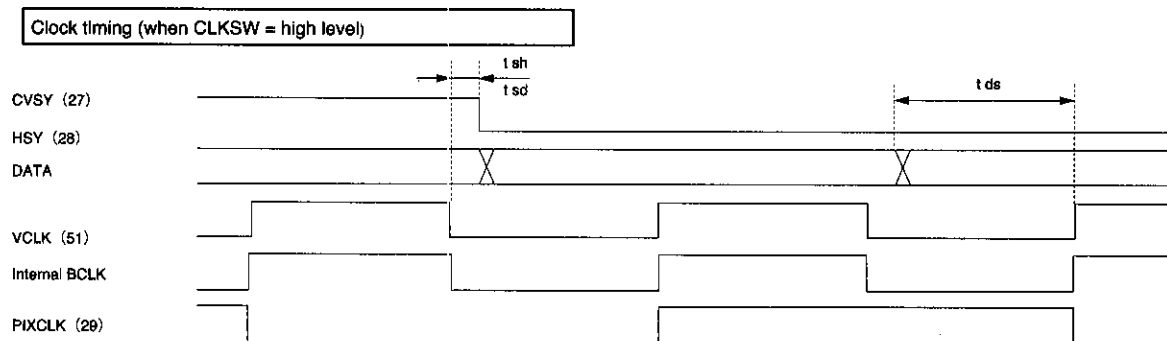

Fig. 6 Clock timing and data input timing

Parameter	Symbol	Unit	Min.	Typ.	Max.
SYNC input hold time	t sh	nS	—	10.0	—
SYNC output delay time	t sd	nS	—	20.0	—
Data setup time	t ds	nS	—	15.0	—

In the slave mode, inputs to HSY and CVSY should be timed according to the timing for HSY (Fig. 6). In the master mode, synchronization signal is output from HSY and CVSY according to the timing as shown in Fig. 6.

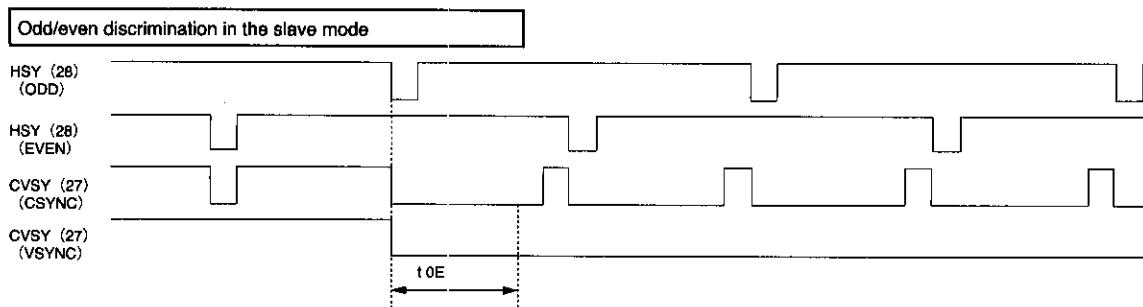

Fig. 7 Odd/even discrimination timing in the slave mode

Parameter	Symbol	Unit	Min.	Typ.	Max.
ODD/EVEN discrimination	t OE	BCLK	—	128	—

In the slave mode, discrimination between odd and even is based on the timing shown above. Set the CSYNC equivalent pulse input to CVSY so that CVSY does not go to the high level until the time shown above has elapsed.

PIXCLK output timing

The frequency of the PIXCLK signal output by BU1417AK is 1/4 of VCLK when CLKSW is at the low level and 1/2 of VCLK when CLKSW is at the high level. PIXCLK is phase-corrected in synchronization with the rise of the input (or output) of HYS.

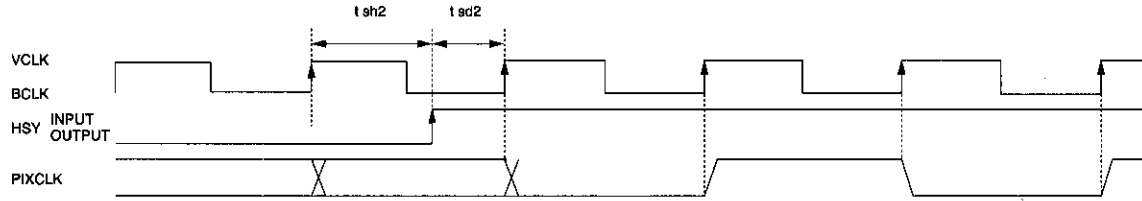

Fig. 8 PIXCLK output timing (when CLKSW = high)

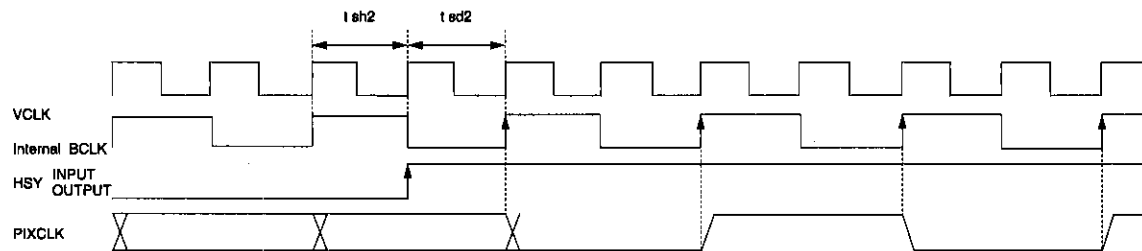

Fig. 9 PIXCLK output timing (when CLKSW = low)

Parameter	Symbol	Unit	Min.	Typ.	Max.
SYNC input hold time ²	t sh2	nS	—	37.0	—
SYNC output delay time	t sd2	nS	—	37.0	—

Digital NTSC/PAL encoders
Multimedia video

Frame timing in the video CD mode (NTSC/PAL60 : interlaced)

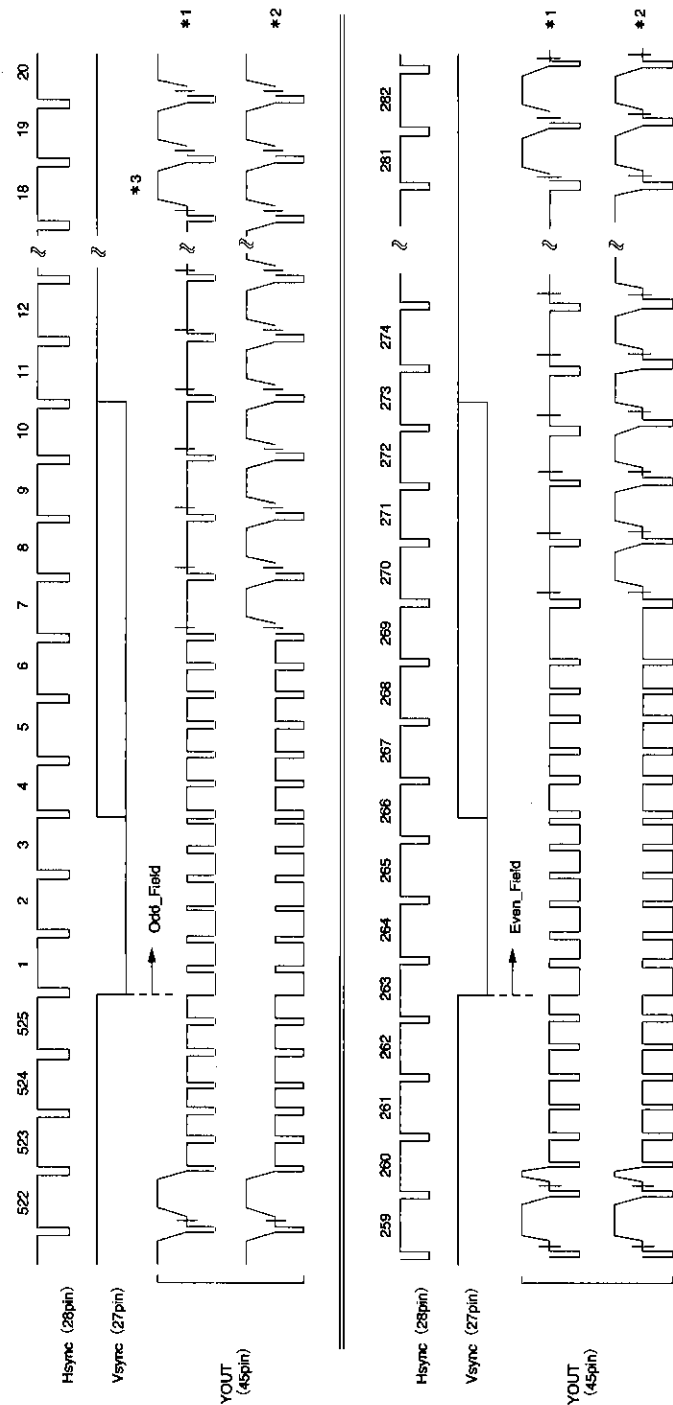
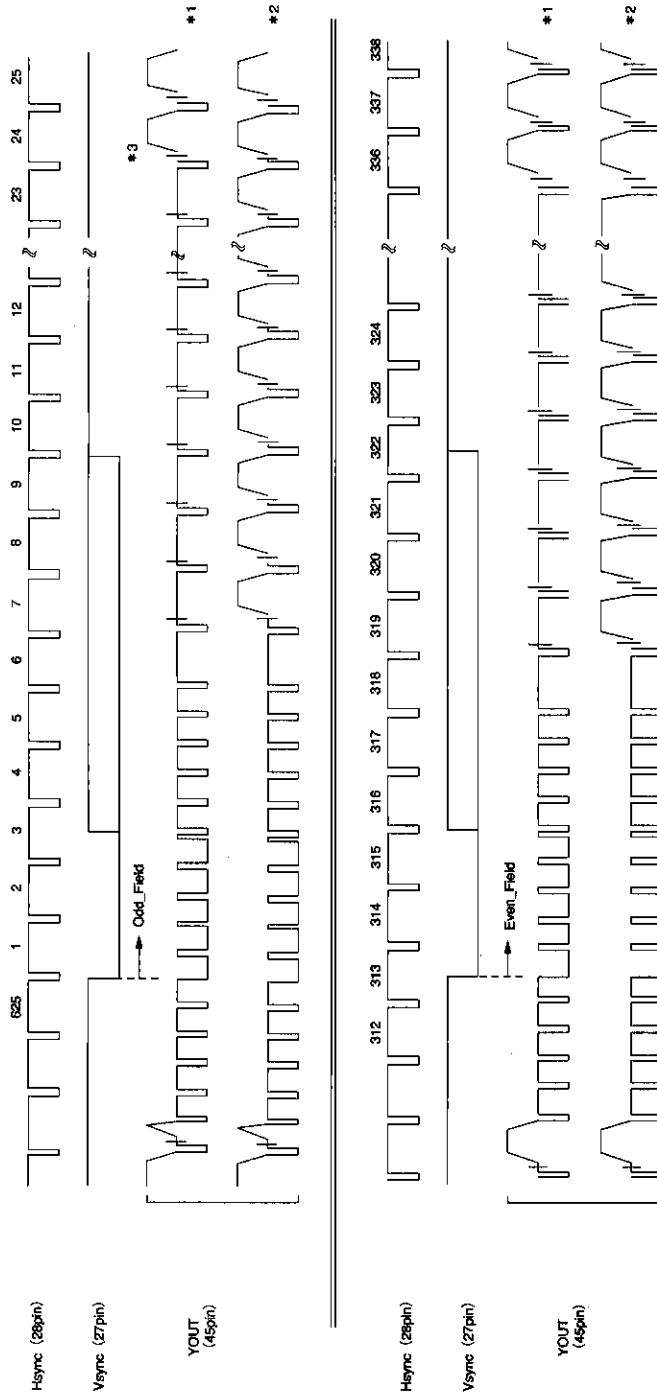

Fig. 10

- * 1 When BLKB (pin 30) is at the low level
- * 2 When BLKB (pin 30) is at the high level.
- * 3 Indicates the line duration of video data output

Frame timing (PAL : interlaced)



- *1 When BLKOE (pin 30) is at the low level
- *2 When BLKOE (pin 30) is at the high level
- *3 Indicates the line duration of video data output

Fig. 11

Television signal timing diagram (NTSC)

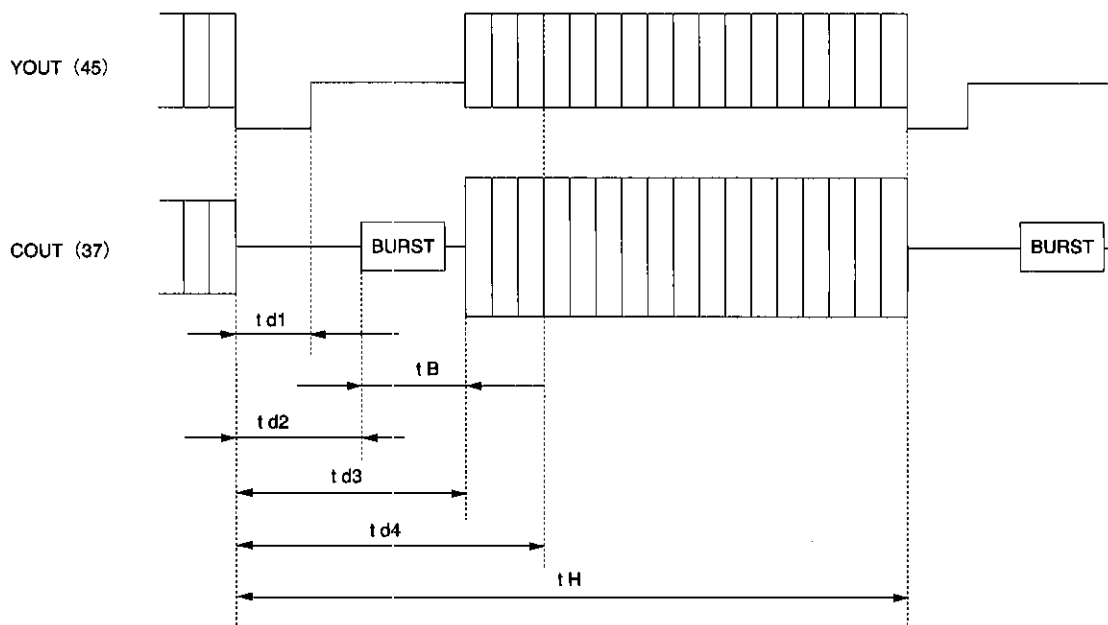

Fig. 12

Parameter	Symbol	Unit	Video - CD	Note
SYNC rise	t d1	VCLK	128	Automatically generated by BU1419K
Burst start	t d2	VCLK	142	Automatically generated by BU1419K
Burst end	t d3	VCLK	212	Automatically generated by BU1419K
Data valid	t d4	VCLK	254	Data input is blank during this period
Line duration	t H	VCLK	1716	Hsync is input during this period
Burst cycle	t B	f _{sc}	9	Automatically generated by BU1419K

* The VCLK counts above apply when CLKSW is at the low level.

Television signal timing diagram (PAL/PAL60)

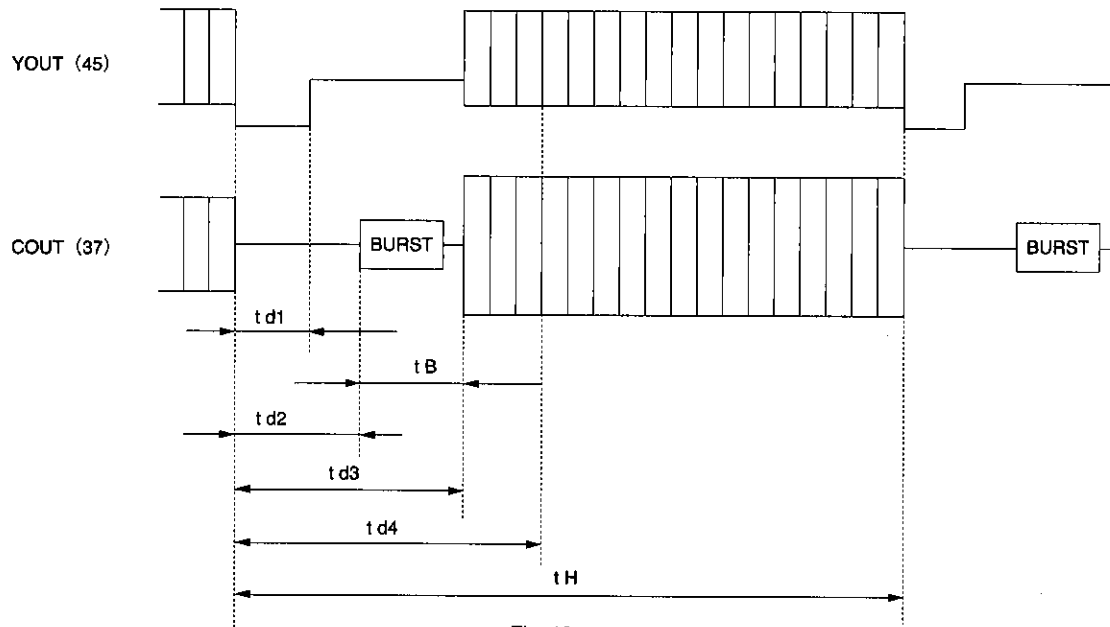

Fig. 13

Parameter	Symbol	Unit	PAL	PAL60	Note
SYNC rise	t d1	VCLK	128	128	Automatically generated by BU1419K
Burst start	t d2	VCLK	152	142	Automatically generated by BU1419K
Burst end	t d3	VCLK	212	212	Automatically generated by BU1419K
Data valid	t d4	VCLK	284	254	Data input is blank during this period
Line duration	t H	VCLK	1728	1716	Hsync is input during this period
Burst cycle	t B	f _{sc}	9	9	Automatically generated by BU1419K

* The VCLK counts above apply when CLKSW is at the low level.

Digital NTSC/PAL encoders

Multimedia video

(5) DAC output level adjustment

The DAC output level is determined by the internal DAC output current and the attached DAC output resistor. The output current of each DAC bit is determined by the VREF pin (pin 35) voltage and by the resistor attached to the IR pin (pin 42) (see below).

$$I (1\text{LSB}) = V_{\text{VREF}} / (R_{\text{IR}} + R_0) \times 1/16 \text{ [A]} \quad \dots \text{ (equation 5-1)}$$

VREF : voltage impressed on VREF [V]

RIR : resistor attached to IR [Ω]

R0 : Internal parasitic resistance of IC [Ω]

Thus, when VVREF = 1.29V and RIR = 1.2k Ω , the current output for each LSB is 63.48 μ A. The white level of Y has a digital value of 396 (decimal) and therefore is calculated as follows :

$$V (\text{Y white}) = 0.06348 \times 396 = 25.14 \text{ [mA]}$$

If a 37.5 Ω resistor is attached to DAC output, amplitude is 0.943 [V_{p-p}].

Similarly, when VVREF = 1.29V and RIR = 1.6k Ω , a per-LSB current of 48.28 μ A is output. The white level of the Y signal has a digital value of 396 (in decimal) and therefore equals the following :

$$V (\text{Y white}) = 0.04828 \times 396 = 19.12 \text{ [mA]}$$

If a 50.0 Ω resistor is attached to DAC output, amplitude is 0.965 [V_{p-p}].

The DAC output level can be fine-tuned according to equation 5-1 on the left. Please contact ROHM when using constants that differ significantly from those above (i.e., output level = 1V_{p-p}, VVREF = 1.29V, RIR = 1.2k Ω or 1.6k Ω , attached DAC output resistor = 37.5 Ω or 50.0 Ω).

● Application example
 (1) Slave mode example

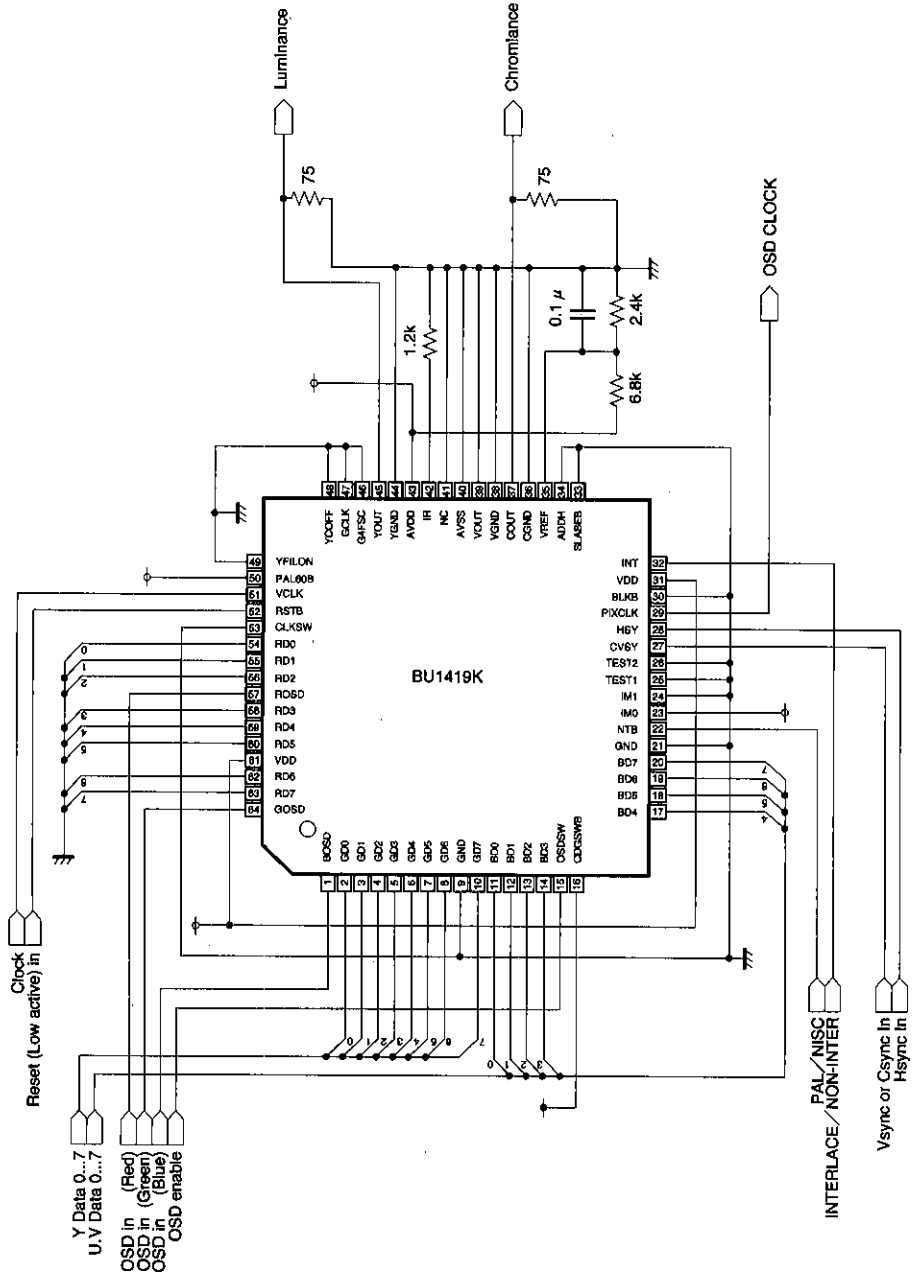

Clock input is the doubled clock signal (27. MHz)
 Mode: YUV (4:2:2) input
 DAC output 75 Ω pull-down (97.5 Ω load at video terminal)

Multimedia video Digital NTSC/PAL encoders

Fig. 14

(2) Master mode example

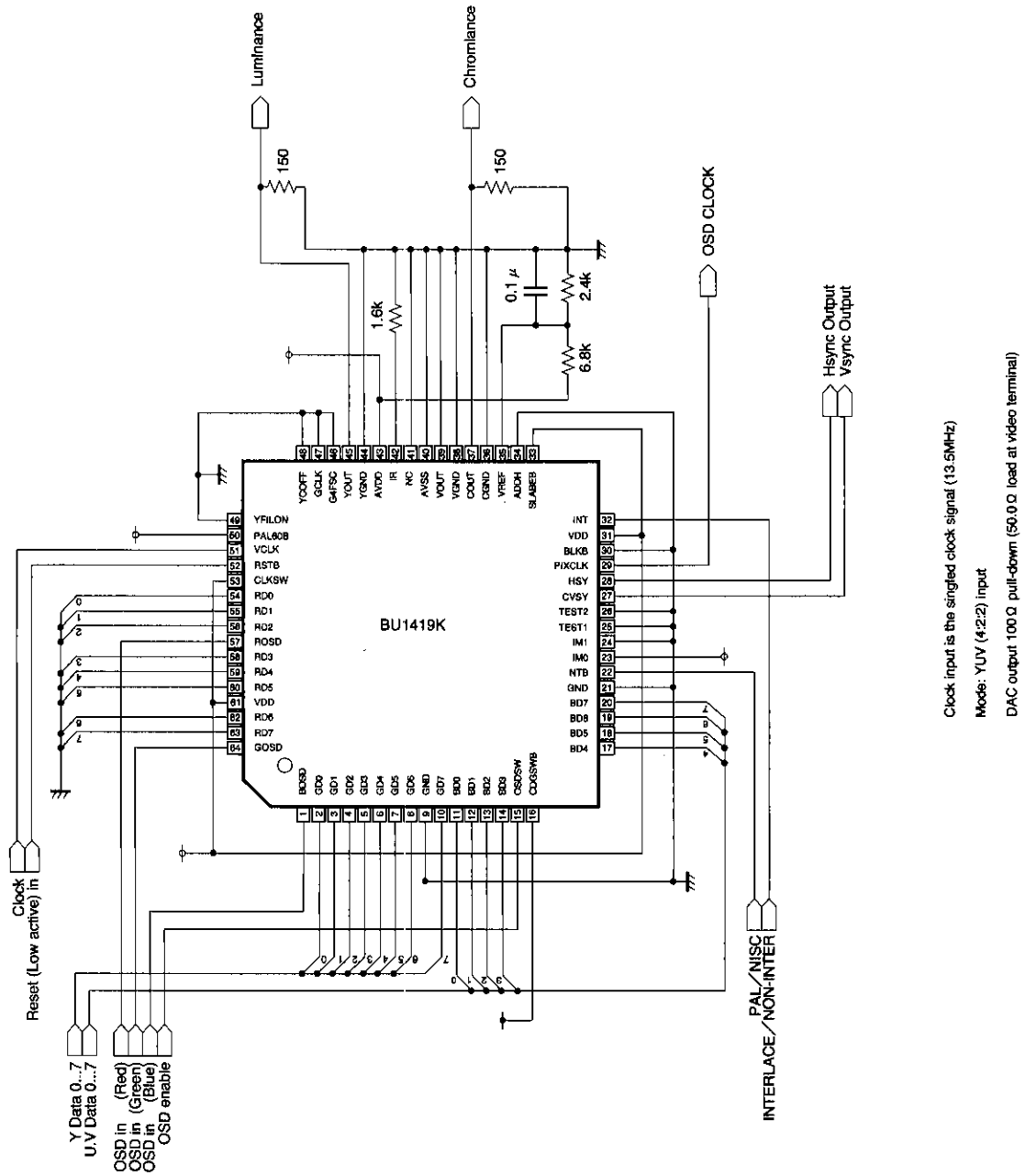
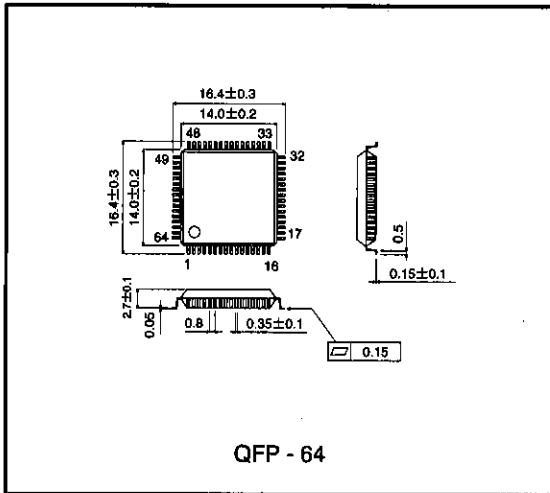

Fig. 15

● External dimensions (Units: mm)



Digital NTSC/PAL encoders

Multimedia video

Notes

- The contents described in this catalogue are correct as of March 1997.
- No unauthorized transmission or reproduction of this book, either in whole or in part, is permitted.
- The contents of this book are subject to change without notice. Always verify before use that the contents are the latest specifications. If, by any chance, a defect should arise in the equipment as a result of use without verification of the specifications, ROHM CO., LTD., can bear no responsibility whatsoever.
- Application circuit diagrams and circuit constants contained in this data book are shown as examples of standard use and operation. When designing for mass production, please pay careful attention to peripheral conditions.
- Any and all data, including, but not limited to application circuit diagrams, information, and various data, described in this catalogue are intended only as illustrations of such devices and not as the specifications for such devices. ROHM CO., LTD., disclaims any warranty that any use of such device shall be free from infringement of any third party's intellectual property rights or other proprietary rights, and further, assumes absolutely no liability in the event of any such infringement, or arising from or connected with or related to the use of such devices.
- Upon the sale of any such devices; other than for the buyer's right to use such devices itself, resell or otherwise dispose of the same; no express or implied right or license to practice or commercially exploit any intellectual property rights or other proprietary rights owned or controlled by ROHM CO., LTD., is granted to any such buyer.
- The products in this manual are manufactured with silicon as the main material.
- The products in this manual are not of radiation resistant design.

The products listed in this catalogue are designed to be used with ordinary electronic equipment or devices (such as audio-visual equipment, office-automation equipment, communications devices, electrical appliances, and electronic toys). Should you intend to use these products with equipment or devices which require an extremely high level of reliability and the malfunction of which would directly endanger human life (such as medical instruments, transportation equipment, aerospace machinery, nuclear-reactor controllers, fuel controllers, or other safety devices) please be sure to consult with our sales representatives in advance.

- Notes when exporting
 - It is essential to obtain export permission when exporting any of the above products when it falls under the category of strategic material (or labor) as determined by foreign exchange or foreign trade control laws.
 - Please be sure to consult with our sales representatives to ascertain whether any product is classified as a strategic material.