

VCR audio signal processing system

BH7775K

The BH7775K is an audio signal processing system IC that includes a peak-noise reduction (PNR) processor, an FM modulator / demodulator circuit, an input / output switcher, an automatic FM detector circuit, an FM band-pass filter, a normal-audio circuit, a regulator circuit, and automatic adjusting circuits (VCO and BPF).

●Applications

VHS Video cassette recorders

●Features

- 1) Operates off dual \pm power supply which allows a large reduction in the number of coupling capacitors required. A built-in regulator makes it easy to construct a power supply system.
- 2) A built-in 2-wire serial control decoder circuit allows serial control of the internal mode settings.
- 3) Automatic adjusting VCO and BPF circuits that use the color signal subcarrier frequency (NTSC: 3.579545MHz and PAL: 4.433619MHz) ensure stable adjustment that is not effected by stress when the chip is mounted, or variations over time.
- 4) 4-input switcher (turner, BS, and line 1 and 2).
Output switch with built-in STEREO / LEFT / RIGHT switching, Hi-Fi / MIX / NORMAL switching, and BS monitor functions.
- 5) The PNR processor and FM modulation / demodulation circuit provide reverse characteristics at recording and playback. Also, carrier frequency adjustment and FM de-emphasis / playback level adjustment have been combined.
- 6) Built-in FM band-pass filter connects directly to the playback amplifier and excels at attenuation of the other channel. The FM recording output circuit has a high-performance high-frequency cutoff filter that produces a sine wave output.
- 7) Switching noise is reduced by a slope-control type differential compensation circuit.
- 8) Built-in envelope detector circuit and noise-detecting automatic FM detector circuit.
- 9) Built-in normal-audio signal processing circuit that allows SP / LP / EP equalizer switching. Control terminal provided for use with the BA7755AF high-voltage head switcher.

● Absolute maximum ratings (Ta = 25°C)

Parameter	Symbol	Limits	Unit
Applied voltage	V _{CC}	23, 55 pin 6.0	V
	V _{EE}	59 pin - 6.0	V
	V _{IN}	7, 8, 22 pin 6.5	V
	V _{IN}	Pin other than above 6.0	V
Power dissipation	P _d	800*	mW
Operating temperature	T _{opr}	- 10 ~ + 70	°C
Storage temperature	T _{stg}	- 55 ~ + 125	°C

* When IC is stand alone, reduced by 8.0mW for each increase in Ta of 1°C over 25°C. When mounted on a 90mm × 50mm, t = 1.6mm glass epoxy board, Pd = 1.3W (reduced by 13.0mW for each increase in Ta of 1°C over 25°C).

○ Not designed for radiation resistance.

● Recommended operating conditions (Ta = 25°C)

Parameter	Symbol	Range	Unit
Power supply voltage	UNREG-V _{CC}	+ 7.0 ~*	V
Power supply voltage	UNREG-V _{EE}	+ 7.0 ~*	V

* The built-in regulator in this IC outputs + 5.0V from pin 55, and - 5.0V from pin 59. The supply voltage range given above is the voltage to be applied to UNREG V_{CC} and UNREG V_{EE} pins in the measurement circuit to obtain regulator output. Therefore, the upper limit of the voltage range is set by the externally connected transistor that forms the regulator circuit, and not by the IC itself. Note, also, that the lower limit will change depending on the value of the resistor connected between the collector and base of the transistor.

●Block diagram

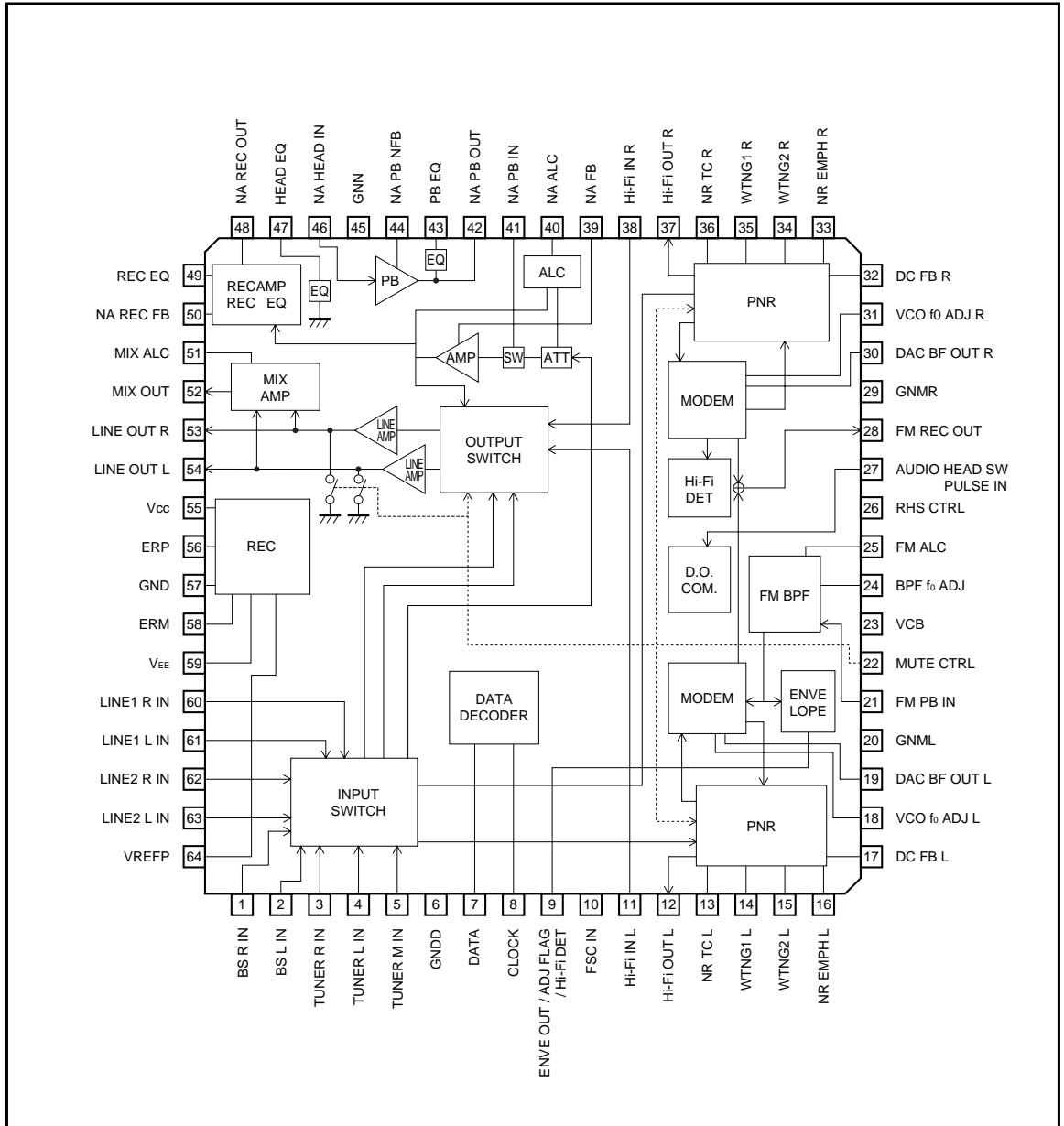

●Pin descriptions

Pin function - 1 / 2

Pin No.	Pin name	Function	Pin voltage	I / O circuit
2, 1	BS IN L, R	BS input (L and R).	0.0V	69.8kΩ
4, 3, 5	TUNER IN L, R, M	TUNER input (L, R, and M).	0.0V	47.0kΩ
6	GNDD	Serial control GND.	0.0V	—
7	DATA IN	Serial control data input.	—	B (PNP)
8	CLOCK IN	Serial control clock input.	—	B (PNP)
9	ENVE OUT / Hi-Fi DET / ADJ FLAG	FM input Lch signal component envelope output. Hi-Fi DET output for FM input. ADJ FLAG output for ADJ.	EE: 0.8V PB: 1.0V	EE: 50kΩ PB, ADJ: EF (NPN)
10	FSC IN	fsc input terminal for VCO and BPF adjustment.	0.0V	200kΩ
11, 38	Hi-Fi IN L, R	Hi-Fi input for output switcher.	0.0V	47kΩ
12, 37	Hi-Fi OUT L, R	PNR audio output.	0.0V	EF: (P-P)
13, 36	NR TC L, R	PNR attack and recovery time setting. Attack R: 530Ω, recovery R: 6.5kΩ.	- 5.0V	—
14, 35	WTNG1 L, R	Waiting characteristic low-frequency time constant setting	0.0V	10kΩ
15, 34	WTNG2 L, R	Waiting characteristic high-frequency time constant setting	0.0V	1.1kΩ
16, 33	NR EMPH L, R	NR emphasis time constant setting. (external C = 0.01μF)	0.0V	—
17, 32	DC FB L, R	PNR operating reference potential.	0.0V	11.5kΩ
18, 31	VCO fo ADJ L, R	VCO control current setting terminal.	2.5V	EF (NPN)
19, 30	VCO DAC BF OUT L, R	VCO control DAC voltage output terminal .	1.4V	EF (NPN)
20, 29	GND (GNM) L, R	PNR, MODEM and BPF GND. L and R unconnected.	0.0V	—
21	FM PB IN	Playback FM input. 660mV _{P-P} Typ. No input coupling capacitor (GND to Vcc).	0.0V	50kΩ
22	MUTE CTRL	Line output mute control input.	—	3kΩ (2.5V Min.)
23	VCB	MODEM and BPF Vcc.	5.0V	—
24	BPF fo ADJ	FM BPF center frequency adjustment.	1.9V	EF (NPN) ~ 200Ω
25	FM ALC	FM ALC time constant setting.	0.0V	EF (NPN) ~ 2.5kΩ
26	RHS CTRL	High-voltage head switch (BA7755) control terminal.	—	C (NPN)
27	AHSWP IN	Audio head switching pulse input.	—	B (PNP)
28	FM REC OUT	EE: recording FM output. Sine wave output. PB: BPF output monitor terminal.	EE: 3.3V PB: 3.3V	EF (NPN) ~ 200Ω

Note) I / O circuit; EF: emitter follower, P-P: push pull, B: base, and C: collector.
All numerical values are standardized values.

Pin function - 2 / 2

Pin No.	Pin name	Function	Pin voltage	I / O circuit
39	NA FB	Normal line amplifier feedback.	0.0V	800Ω
40	NA ALC	Normal line amplifier ALC time constant setting (attack and recovery time).	0.0V	EF (NPN) ~ 500Ω
41	NA PB IN	Normal line amplifier playback input.	0.0V	105.2kΩ
42	NA PB OUT	Normal PB amplifier output.	0.0V	EF (P-P) ~ 50Ω
43	PB EQ	Normal PB amplifier equalizer switch.	0.0V	OPEN / 25Ω
44	NA PB NFB	Normal PB amplifier feedback.	0.0V	B (NPN)
45	GNN	Normal audio GND.	0.0V	—
46	NA HEAD IN	Normal audio playback input.	0.0V	REC: B (NPN) REC: EF (P-P)
47	HEAD EQ	Head resonance equalizer switch terminal.	0.0V	300kΩ / 29Ω
48	NA REC OUT	Normal REC amplifier output.	0.0V	EF: (P-P)
49	REC EQ	Recording equalizer setting resistor terminal.	0.0V	1kΩ
50	NA REC FB	Normal REC amplifier feedback terminal.	0.0V	B (NPN)
51	MIX ALC	ALC time constant setting for mixer amplifier (attack and recovery time).	- 5.0V	EF (NPN) ~ 500Ω
52	MIX OUT	Mixer amplifier output for RF converter.	0.0V	EF (NPN)
54, 53	LINE OUT L, R	Line output	0.0V	330Ω
55	V _{CC}	V _{CC} regulator.	5.0V	—
56	ERP	V _{CC} regulator error output.	5.0V	C (NPN)
57	GND	Output switch, regulator GND.	0.0V	—
58	ERM	V _{EE} regulator error output.	- 5.0V	C (PNP)
59	V _{EE}	V _{EE} regulator	- 5.0V	—
61, 60	LINE1 IN L, R	LINE 1 input (L and R).	0.0V	90.2kΩ
63, 61	LINE2 IN L, R	LINE 2 input (L and R).	0.0V	90.2kΩ
64	VREFP	V _{CC} / 2 reference voltage. With power on detect and precharge function.	2.5V	10kΩ

* I / O circuit; EF: emitter follower, P-P: push pull, B: base, and C: collector.
All numerical values are standardized values.

●Input / Output circuits

Equivalent circuits for the control and input / output circuits - (1)

TUNER L, R, M (4, 3, 5pin)

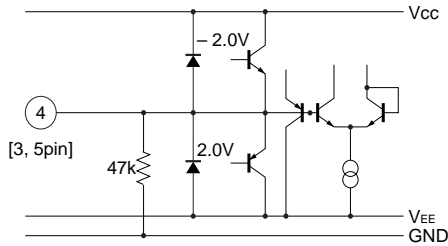

LINE1 L / R, LINE2 L / R (61, 60, 63, 62pin)

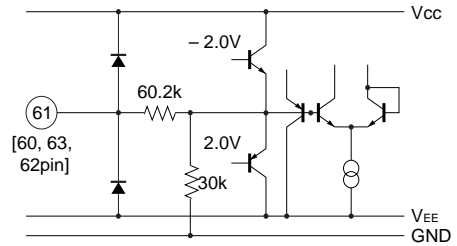

BS L, R (2, 1pin)

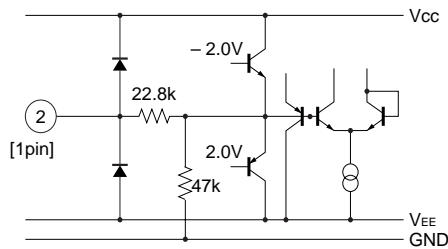

LINE OUT (54, 53pin)

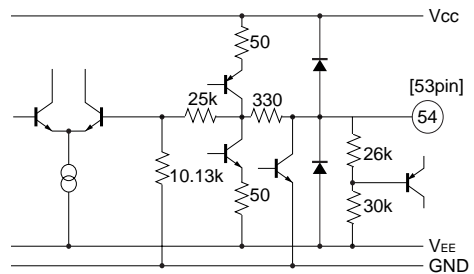

MIX OUT (52pin)

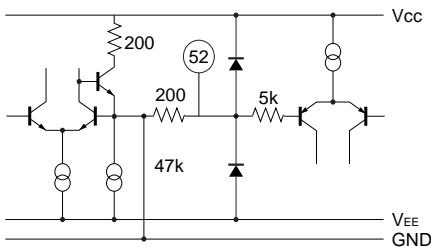

FM REC OUT (28pin)

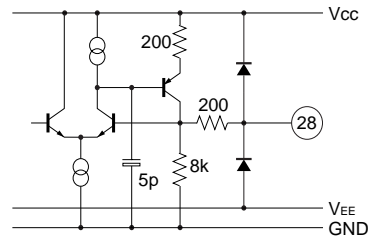

Equivalent circuits for the control and input / output circuits - (2)

FM PB IN (21pin)

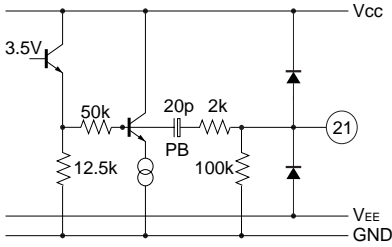

NA PB IN (41pin)

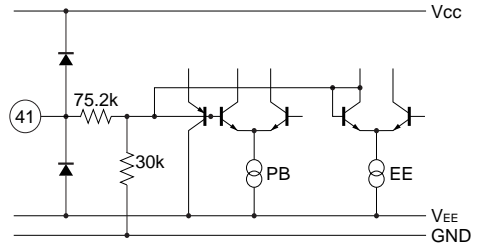

NA PB OUT (42pin)

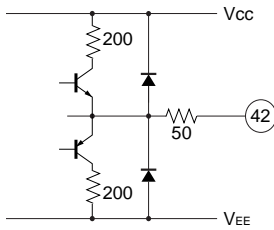

NA PB NFB (44pin), NA HEAD IN (46pin)

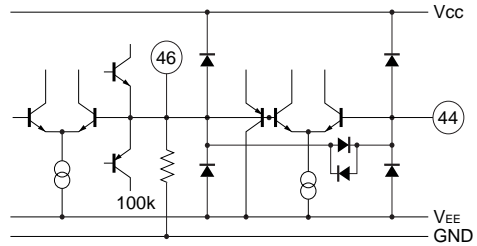

NR REC OUT (48pin), NA REC NFB (50pin)

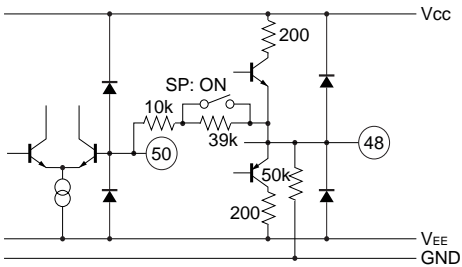

Equivalent circuits for the control and input / output circuits - (3)

AUDIO HEAD SWITCH PULSE IN (27pin)

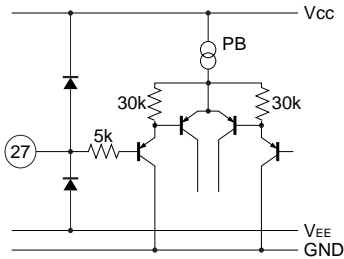

ENVELOPE / Hi-Fi DET OUT (9 pin)

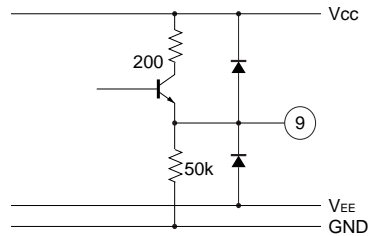

RHS CTRL (26pin)

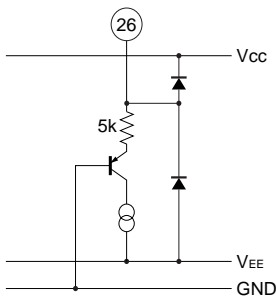

MUTE CTRL (22pin)

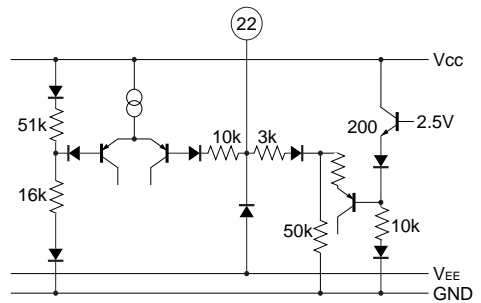

DATA (7pin), CLOCK (8pin)

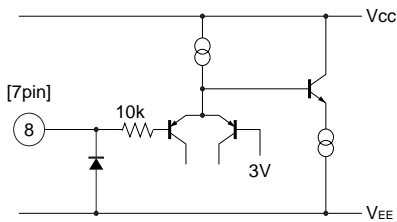

FSC IN (10pin)

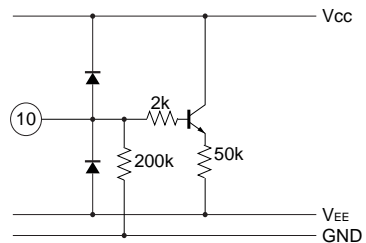

●Electrical characteristics

• Unless otherwise noted, the following measurement conditions apply:

UNREG – V_{CC} = + 10V

UNREG – V_{EE} = – 10V

T_a = 25°C

* With regard to the control voltages, refer to the mode holding voltage range given in p.141.

Output switch control (W1 bit 4, W1 bit 3 and W1 bit 2)	STEREO
BS Through control (W1 bit 1)	: OFF
LINE AMP gain (W3 bit 4 and W3 bit 3)	: Standard (+ 10.6dB)
FM output control (W2 bit 5)	: FM output on
FM OUT switch control (W2 bit 4, W2 bit 3 and W2 bit 2)	: FM REC output MIX ration (– 10.0dB)
NTSC / PAL control (W2 bit 0)	: NTSC
Recording MUTE (W2 bit 1)	: Recording $\overline{\text{MUTE}}$
SP / EP control (W1 bit 5)	: SP
FM detector level control (W4 bit 7, W4 bit 6)	: Standard
ENVE characteristic control (W4 bit 5, W4 bit 4)	: FNORM detector, no ENVE output
MUTE CTRL (pin 22)	: L ($\overline{\text{MUTE}}$)
LINE MUTE (W1 bit 0)	: L ($\overline{\text{MUTE}}$)
MODEM carrier frequency	NTSC L channel 1.30MHz, PAL Lch 1.40MHz
MODEM carrier frequency	NTSC R channel 1.70MHz, PAL Rch 1.80MHz
Color signal subcarrier frequency	NTSC 3.579545MHz, PAL 4.433619MHz

Signal frequency f = 1kHz

- Input condition 1 TU input V_{IN} = – 20.0dBV, LINE1 / LINE2 input V_{IN} = – 10.0dBV, BS input V_{IN} = – 16.0dB
- Input condition 2 TU input V_{IN} = – 10.6dBV, LINE1 / LINE2 input V_{IN} = – 0.6dBV, BS input V_{IN} = – 6.6dB
- Input condition 3 TU input V_{IN} = – 15.0dBV, LINE1 / LINE2 input V_{IN} = – 5.0dBV, BS input V_{IN} = – 11.0dB
- Input condition 4 TU input V_{IN} = – 5.0dBV, LINE1 / LINE2 input V_{IN} = + 5.0dBV, BS input V_{IN} = – 1.0dB

* 1 B.W. = 0.4 to 30kHz * 2 DIN AUDIO

* Refer to Fig. 1 for the measurement circuit.

Parameter	Symbol	Min.	Typ.	Max.	Unit	Conditions
[REGULATOR]						
Quiescent Current (positive supply) EE	I _{qp} EE	29.0	38.6	51.3	mA	EE mode, no input, after carrier frequency adjustment.
Quiescent Current (positive supply) PB	I _{qp} PB	40.3	53.7	71.4	mA	PB mode, no input, FNORM, BPF, after carrier frequency adjustment.
Quiescent Current (negative supply) EE	I _{qm} EE	– 22.1	– 16.6	– 12.5	mA	EE mode, no input, after carrier frequency adjustment.
Quiescent Current (negative supply) PB	I _{qm} PB	– 23.9	– 18.0	– 13.5	mA	PB mode, no input, FNORM, BPF, after carrier frequency adjustment.
Regulator input voltage (+)	V _{CC}	4.69	5.04	5.39	V	
Regulator input voltage (–)	V _{EE}	– 5.37	– 5.02	– 4.67	V	

Parameter	Symbol	Min.	Typ.	Max.	Unit	Conditions
[Hi-Fi EE THROUGH] (INPUT: TU IN L / R, LINE1 IN L / R, LINE2 IN L / R, BS IN L / R OUTPUT: LINE OUT L / R)						
〈MANUAL MODE〉						
Line output level	V _{OEE}	- 10.6	- 9.4	- 8.2	dBV	Input condition 1
Channel balance (L / R)	CB _{EE}	- 0.8	0.0	0.8	dB	Input condition 1
Distortion	THD _{EE}	—	0.017	0.10	%	Input condition 1* ¹
Maximum output level	V _{OMEE}	9.0	10.7	—	dBV	THD = 1%,* ¹
Output residual noise	V _{ONEE}	—	- 93.0	- 86.0	dBV	Relevant input shorted to GND,* ²
Crosstalk	CT _{EE}	—	—	- 75.0	dBV	Relevant input: shorted to GND Non-relevant input: Input condition 2,* ²
Muting level	MTEE	—	- 105	- 95	dBV	Input condition 2* ²
Switching DC offset	ΔV _{MODE}	—	8.0	22	mV	(LINE OUT) ST / L / R / N, MIX ON / OFF Mode switching operating point voltage difference.
[BS THROUGH] (INPUT: BS IN L / R OUTPUT: LINE OUT L / R)						
Output level	V _{OBS}	- 10.5	- 9.3	- 8.1	dBV	V _{IN} = - 16.0dBV
Distortion	THD _{BS}	—	0.006	0.08	%	V _{IN} = - 16.0dBV,* ¹
Output residual noise	V _{ONBS}	—	- 96.0	- 86.0	dBV	* ² , Connect BS IN to GND.
[LINE AMP] (INPUT: Hi-Fi IN L / R OUTPUT: LINE OUT L / R)						
Line amplifier gain 1	V _{OLINE1}	+ 10.0	+ 10.6	+ 11.2	dB	V _{IN} = - 20.0dBV
Line amplifier gain 2	V _{OLINE2}	+ 11.2	+ 11.8	+ 12.4	dB	V _{IN} = - 20.0dBV
Line amplifier gain 3	V _{OLINE3}	+ 13.1	+ 13.7	+ 14.3	dB	V _{IN} = - 20.0dBV
[MIX AMP] (INPUT: TU IN L / R, LINE1 IN L / R, LINE2 IN L / R, BS IN L / R OUTPUT: MIX OUT)						
Output level	V _{OMIX}	- 10.6	- 9.4	- 8.2	dBV	Input condition 1, simultaneous L & R input
Distortion	THD _{MIX}	—	0.08	0.50	%	Input condition 1, simultaneous L & R input* ¹
MIX ALC level	V _{ALCMIX}	- 4.4	- 2.9	- 1.4	dBV	Input condition 2, simultaneous L & R input
[NORMAL EE THROUGH] (INPUT: TU IN M, TU IN L / R, LINE1 IN L / R, LINE2 IN L / R, BS IN L / R OUTPUT: LINE OUT L / R)						
Output voltage level	V _{OEE}	- 11.6	- 10.4	- 9.2	dBV	Input condition 1
Distortion	THD _{EEN}	—	0.039	0.10	%	Input condition 1,* ¹
Output residual noise	V _{ONEEN}	—	- 81.5	- 71.3	dBV	R _g = 1kΩ,* ²
ALC level 1	V _{ALCN1}	- 8.9	- 7.4	- 5.9	dBV	Input condition 4
ALC distortion	THD _{ALCN}	—	0.045	0.15	%	Input condition 4,* ¹
[NORMAL REC AMP] (INPUT: TU IN M, TU IN L / R, LINE1 IN L / R, LINE2 IN L / R, BS IN L / R OUTPUT: NA REC OUT)						
Output voltage level	V _{ORECN}	- 9.6	- 8.1	- 6.6	dBV	Input condition 1
Distortion	THD _{RECN}	—	0.079	0.20	%	Input condition 1,* ¹
Maximum output level	V _{OMRCN}	7.0	9.2	—	dBV	THD = 1%,* ¹ , ALC OFF
Output level for EE	MT _{RECN}	—	- 94.0	- 70.0	dBV	Input condition 2,* ² , EE MODE, ALC OFF

Parameter	Symbol	Min.	Typ.	Max.	Unit	Conditions
[NORMAL PB AMP] (INPUT: NA HEAD IN, OUTPUT: LINE OUT)						
Output voltage level	V_{OPSN}	-13.4	-11.6	-9.8	dB	$V_{IN} = -70\text{dBV}$
Distortion	THD_{PBN}	—	0.19	0.40	%	$V_{IN} = -70\text{dBV}$, *1
Output residual noise	V_{ONPBN}	—	-63.6	-55.0	dBV	$R_g = 1\text{k}\Omega$, *2
Open loop gain (PB PRE AMP)	G_{VPBNOR}	58.0	66.7	—	dB	$V_{IN} = -70\text{dBV}$ OUTPUT: NA PB OUT
[EQ SWITCH]						
REC FB resistance SP	$R_{REC\ SP}$	8.3	10.0	11.7	$\text{k}\Omega$	SP MODE
REC FB resistance EP	$R_{REC\ EP}$	40.7	49.0	57.3	$\text{k}\Omega$	EP MODE
REC EQ resistance	$R_{REC\ EQ}$	0.83	1.00	1.17	$\text{k}\Omega$	Resistor connected between pin 49 and GND.
PB EQ SW impedance	$R_{EQ\ PB}$	—	25	50	Ω	SP MODE
HEAD EQ SW impedance	$R_{EQ\ HEAD}$	—	29	50	Ω	EP MODE
[RHS CONTROL]						
RHS control current	$I_{IN\ RHS}$	98	118	140	μA	
RHS control leakage current	$I_{L\ RHS}$	—	—	1	μA	
[PNR ENCODE MODE]						
Encode output level	V_{OENC}	-17.0	-15.7	-14.4	dBV	Input condition 1
Compression characteristic	CMP	-26.4	-24.7	-23.0	dB	TU input $V_{IN} = -20\text{dBV} \rightarrow -70\text{dBV}$ output level difference.
Encode distortion	THD_{END}	—	0.17	0.37	%	Input condition 1, *1
Output residual noise	V_{ONEC}	—	-56.5	-51.5	dBV	Connect the pertinent input to GND, *2
[PNR DECODE MODE]						
Output voltage level	V_{ODEC}	-11.2	-9.4	-7.6	dBV	$V_{IN} = -15.7\text{dBV}$
Expansion characteristic	EXP	-52.4	-50.2	-48.0	dB	$V_{IN} = -15.7\text{dBV} \rightarrow -40.7\text{dBV}$ output level difference.
Time constant setting resistor	R_{DET}	5.10	6.15	7.20	$\text{k}\Omega$	Resistance value connected between pins 13 and 36 and VEE. (when VCCS and VEES applied)

Parameter	Symbol	Min.	Typ.	Max.	Unit	Conditions	
[MODEM REC MODE] (INPUT: TUNER IN L / R, LINE1 IN L / R, LINE2 IN L / R, BS IN L / R, OUTPUT: FM REC OUT L / R)							
Carrier frequency NTSC	Lch	f_{NOL}	1.2950	1.3000	1.3050	MHz	No input, V_{CC} stable, after automatic adjustment $f_{SC} = 3.579545\text{MHz}$ $V_{IN} = 150 \sim 500\text{mV}_{P-P}$
	Rch	f_{NOR}	1.6950	1.7000	1.7050	MHz	
Carrier frequency PAL	Lch	f_{POL}	1.3945	1.4000	1.4055	MHz	No input, V_{CC} stable, after automatic adjustment $f_{SC} = 4.433619\text{MHz}$ $V_{IN} = 150 \sim 500\text{mV}_{P-P}$
	Rch	f_{POR}	1.7935	1.7990	1.8045	MHz	
Frequency deviation	Lch	DEV_L	45.5	51.5	57.5	\pm kHz	Input condition 1
	Rch	DEV_R	45.0	51.0	57.0	\pm kHz	
Maximum frequency deviation	Lch	$DEV_{Max.L}$	116	138	160	\pm kHz	Input condition 4 ($f = 10\text{kHz}$)
	Rch	$DEV_{Max.R}$	116	138	160	\pm kHz	
FM output level	Lch	V_{OFML}	320	365	420	mV_{P-P}	FM OUT SW: FM L mode
	Rch	V_{OFMR}	325	370	425	mV_{P-P}	FM OUT SW: FM R mode
Carrier 2nd harmonic	Lch	f_{2L}	—	-53.0	-40.0	dB	2nd stage harmonics and fundamental harmonics spectral ratio Lch: FM L mode, Rch: FM R mode
	Rch	f_{2R}	—	-48.0	-40.0	dB	
Carrier 3rd harmonic	Lch	f_{3L}	—	-52.0	-40.0	dB	3rd stage harmonics and fundamental harmonics spectral ratio Lch: FM L mode, Rch: FM R mode
	Rch	f_{3R}	—	-55.0	-42.0	dB	
FM MIX ratio (FM MIX1 mode)		f_{LR}	-12.0	-10.2	-8.4	dB	1.3MHz / 1.7MHz spectrum ratio.

[MODEM PB MODE] (INPUT: FM PB IN, OUTPUT: LINE OUT L / R)

Carrier frequency, after BPF fo adjustment, $V_{IN} = 660\text{mV}_{P-P}$, 1.30MHz, 1.70MHz MIX IN

Demodulation output level	Lch	V_{ODL}	-11.5	-9.3	-7.1	dBV	$DEV_L = \pm 50.0\text{kHz}$, $f = 1\text{kHz}$
	Rch	V_{ODR}	-11.5	-9.3	-7.1	dBV	$DEV_R = \pm 50.0\text{kHz}$, $f = 1\text{kHz}$
Demodulation output level 2	Lch	V_{ODL2}	V_{ODL} -10.0	V_{ODL} -7.5	V_{ODL} -5.0	dBV	$DEV_L = \pm 50.0\text{kHz}$, $f = 10\text{kHz}$
	Rch	V_{ODR2}	V_{ODR} -10.0	V_{ODR} -7.5	V_{ODR} -5.0	dBV	$DEV_R = \pm 50.0\text{kHz}$, $f = 10\text{kHz}$
Demodulation distortion	Lch	THD_{DL}	—	0.12	0.35	%	$DEV_L = \pm 50.0\text{kHz}$, $f = 1\text{kHz}$, *1
	Rch	THD_{DR}	—	0.13	0.35	%	$DEV_R = \pm 50.0\text{kHz}$, $f = 1\text{kHz}$, *1
Demodulation SW noise level	Lch	V_{ODSWL}	—	—	—	dBV	$f = 10\text{kHz}$, AUDIO H. SW. P = - Hz 5V _{P-P} rectangular-waveform input. After 10kHz TRAP passes DEV. = $\pm 25.0\text{kHz}$ *2
	Rch	V_{ODSWR}	—	—	—	dBV	
Demodulation noise level	Lch	V_{ONDL}	—	-95.0	-85.0	dBV	Unmodulated *2
	Rch	V_{ONDR}	—	-95.0	-85.0	dBV	

[Recording→ playback total characteristics] (EE . . . INPUT: LINE IN L / R, OUTPUT: LINE OUT L / R)

(PB . . . INPUT: FM PB IN, OUTPUT: LINE OUT L / R)

Line output recording / playback level difference	Lch	V_{RPL}	-1.2	0.0	+1.2	dB	EE mode: $V_{IN} = -10.0\text{dBV}$ after carrier frequency adjustment.
	Rch	V_{RPR}	-1.2	0.0	+1.2	dB	

PB mode: Input FM PB IN = 660mV_{P-P} , $f = 1.30\text{MHz}$, 1.70MHz 1: 1 MIX, after BPF center frequency adjustment. Inp
DEV = $DEV_{L,R}$ (frequency deviation given above). EE / PB line out level difference.

Parameter	Symbol	Min.	Typ.	Max.	Unit	Conditions
[FM BPF] (INPUT: FMPB IN, OUTPUT: BPF MONITOR L / R) V_{CC} stable, after automatic adjustment						
BPF L / R level difference NTSC	ΔV_{BPFN}	- 5.0	0.0	5.0	dB	$f = 1.505\text{MHz}$, $V_{IN} = 200\text{mV}_{P-P}$
BPF L / R level difference PAL	ΔV_{BFPF}	- 5.0	0.0	5.0	dB	$f = 1.605\text{MHz}$, $V_{IN} = 200\text{mV}_{P-P}$
⟨Lch, Rch mix input signal⟩ 660mV_{P-P} (RATIO 1: 1), FM ALC ON						
⟨NTSC Lch⟩						
1.30MHz insertion loss	ATT_{NLC}	- 14.2	- 11.1	- 8.1	dB	1.30MHz + 1.70MHz
1.15MHz attenuation	ATT_{NL} 1.15	ATT_{NLC} - 9.5	ATT_{NLC} - 5.0	ATT_{NLC} - 2.0	dB	1.15MHz + 1.70MHz
1.45MHz attenuation	ATT_{NL} 1.45	ATT_{NLC} - 8.6	ATT_{NLC} - 5.0	ATT_{NLC} - 2.0	dB	1.45MHz + 1.70MHz
1.70MHz attenuation	ATT_{NL} 1.70	—	—	ATT_{NLC} - 30.0	dB	1.30MHz + 1.70MHz
⟨NTSC Rch⟩						
1.70MHz insertion loss	ATT_{NRC}	- 15.5	- 12.3	- 9.3	dB	1.30MHz + 1.70MHz
1.55MHz attenuation	ATT_{NR} 1.55	ATT_{NRC} - 8.3	ATT_{NRC} - 4.7	ATT_{NRC} - 1.9	dB	1.55MHz + 1.30MHz
1.85MHz attenuation	ATT_{NR} 1.85	ATT_{NRC} - 10.6	ATT_{NRC} - 5.4	ATT_{NRC} - 1.6	dB	1.85MHz + 1.30MHz
1.30MHz attenuation	ATT_{NR} 1.30	—	—	ATT_{NRC} - 30.0	dB	1.30MHz + 1.70MHz
⟨PAL Lch⟩						
1.40MHz insertion loss	ATT_{PLC}	- 1.28	- 9.7	- 6.7	dB	1.40MHz + 1.80MHz
1.25MHz attenuation	ATT_{PL} 1.25	—	ATT_{PLC} - 5.0	—	dB	1.25MHz + 1.80MHz
1.55MHz attenuation	ATT_{PL} 1.55	—	ATT_{PLC} - 5.2	—	dB	1.55MHz + 1.80MHz
1.80MHz attenuation	ATT_{PL} 1.80	—	—	ATT_{PLC} - 30.0	dB	1.40MHz + 1.80MHz
⟨PAL Rch⟩						
1.80MHz insertion loss	ATT_{PRC}	- 14.8	- 11.6	- 8.6	dB	1.40MHz + 1.80MHz
1.65MHz attenuation	ATT_{PR} 1.65	—	ATT_{PRC} - 4.6	—	dB	1.65MHz + 1.40MHz
1.95MHz attenuation	ATT_{PR} 1.95	—	ATT_{PRC} - 5.3	—	dB	1.95MHz + 1.40MHz
1.40MHz attenuation	ATT_{PR} 1.40	—	—	ATT_{PRC} - 30.0	dB	1.40MHz + 1.80MHz

Parameter	Symbol	Min.	Typ.	Max.	Unit	Conditions
[DO detect circuit]						
DO detector level	V _{DDO}	77.0	83.0	89.0	dB μ	Input level to give DO due to attenuation.
[FNORM to Hi-Fi return delay circuit]						
Return delay time	t _{FNDLY}	110	125	140	ms	FM PB IN (1.3MHz, 1.7MHz, 1: 1 MIX) time from 660mV _{P-P} input to ENVE OUT rise. Audio head pulse in: f = 30Hz, 5V _{P-P} rectangular waveform.
[Envelope output circuit] (INPUT: FM PB IN, OUTPUT: ENVE OUT) 0dB = 660mV _{P-P} , 1.3MHz & 1.7MHz MIX IN						
Envelope output level SP0	V _{ENVSP0}	—	0	100	mV	No signal, SP MODE
Envelope output level SP1	V _{ENVSP1}	2.22	2.72	3.22	V	V _{IN} = 0dB, SP MODE
Envelope output level SP2	V _{ENVSP2}	3.70	3.95	4.20	V	V _{IN} = + 10dB, SP MODE
Envelope output level EP1	V _{ENVEP1}	2.18	2.68	3.18	V	V _{IN} = - 4dB, EP MODE
Hi-Fi DET output DC FNORMAL	V _{HDETL}	—	0	100	mV	No signal
Hi-Fi DET output DC HiFi	V _{HDETH}	3.50	4.00	—	V	V _{IN} = 0dB
[Hold pulse circuit]						
Audio head switch pulse threshold voltage	V _{THHOLD}	1.66	2.66	3.66	V	Hysteresis (0.5V)
Hold pulse width	Δ t _{HOLD}	6.47	7.77	9.07	μ s	
[Voltage for preserving the control system mode]						
<CLOCK IN>						
L mode holding voltage	V _{H8L}	0.0	—	0.5	V	
H mode holding voltage	V _{H8H}	2.5	—	V _{CC}	V	
<DATA IN>						
L mode holding voltage	V _{H7L}	0.0	—	0.5	V	
H mode holding voltage	V _{H7H}	2.5	—	V _{CC}	V	
MUTE CTRL						
$\overline{\text{MUTE}}$ holding voltage	V _{H22L}	0.0	—	1.0	V	
DC MUTE holding voltage	V _{H22H}	3.9	—	V _{CC}	V	

●Application example

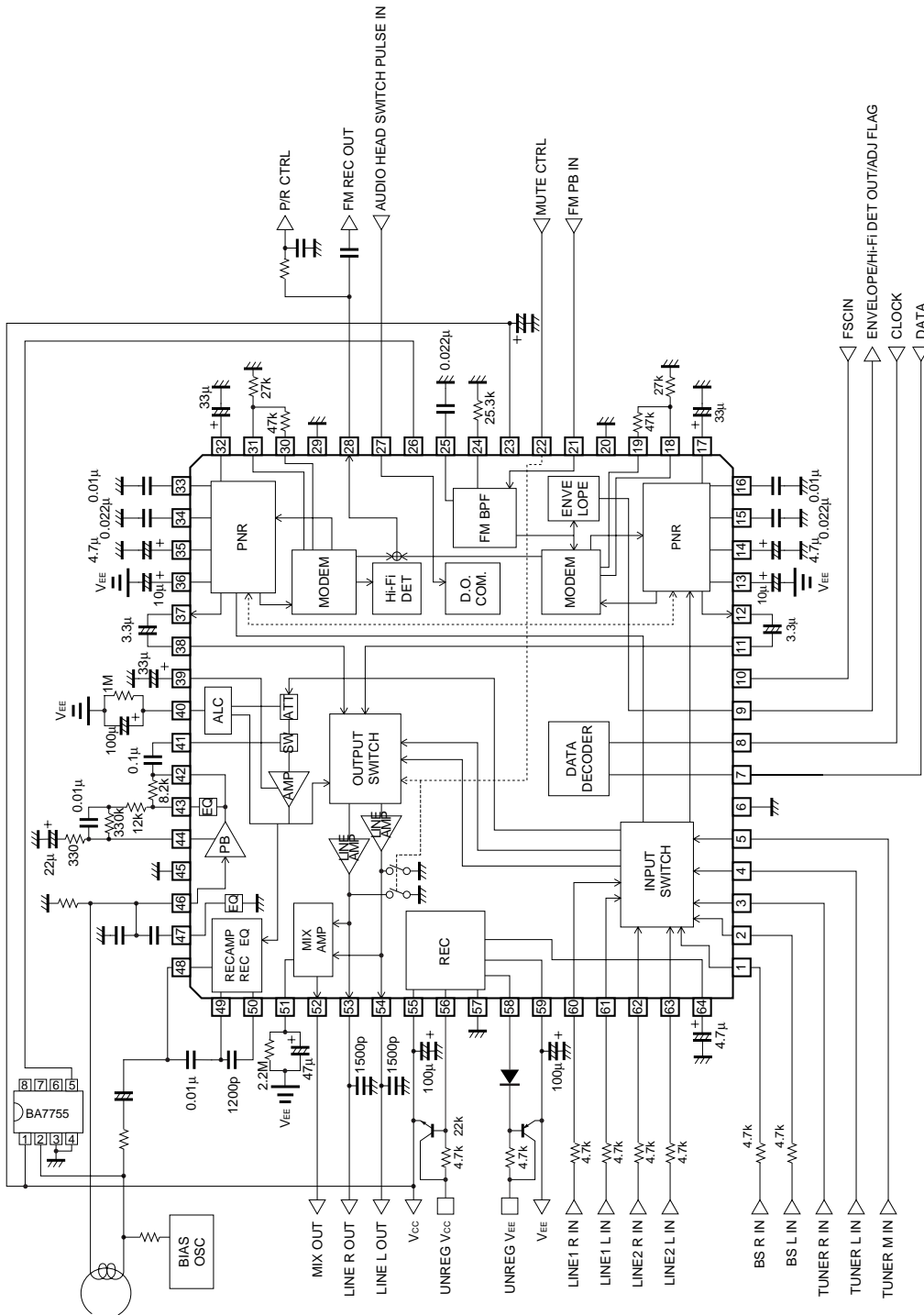

Fig.2

●Electrical characteristic curve

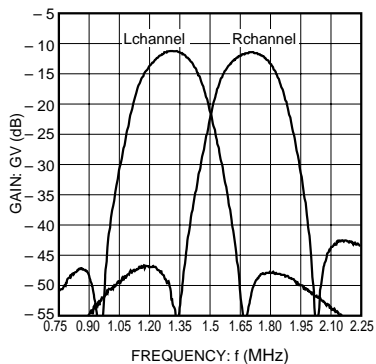
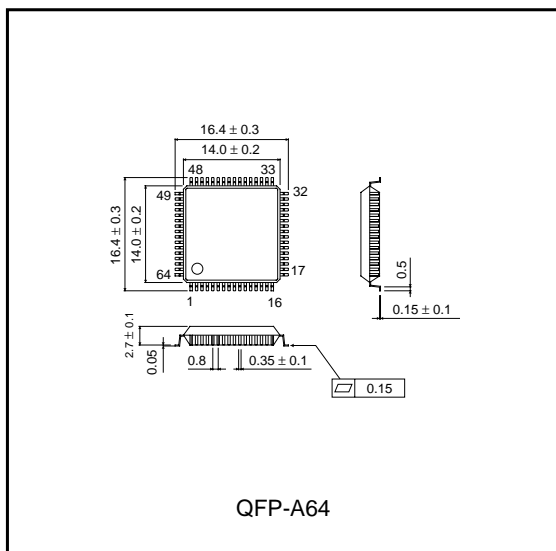

Fig. 3 FM BPF frequency characteristics (NTSC)

●External dimensions (Units: mm)



QFP-A64